

The Jane Stickle Quilt - Row D

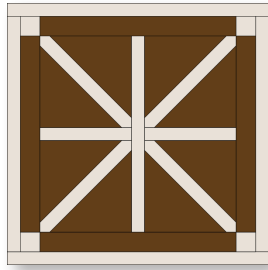

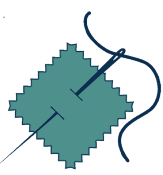

D1

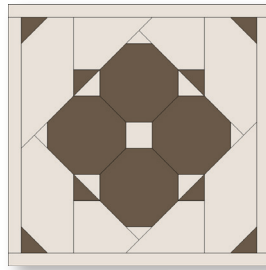

D2

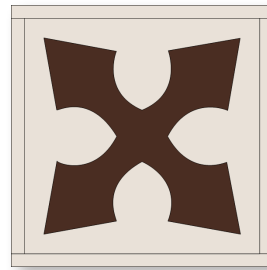

D3

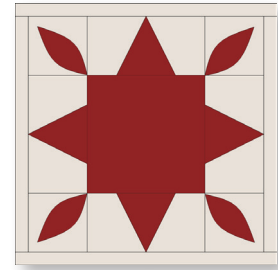

D4

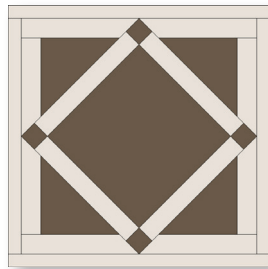

D5

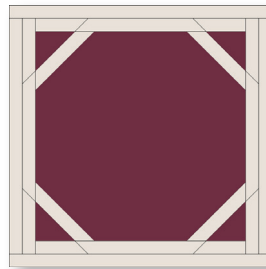

D6

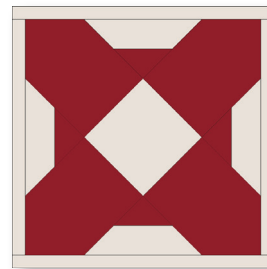

D7

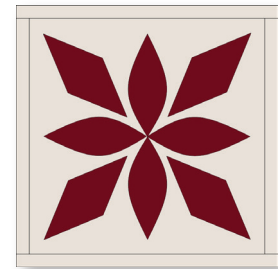

D8

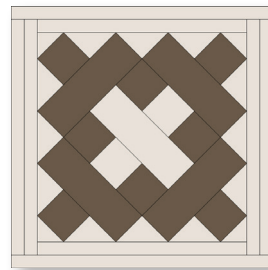

D9

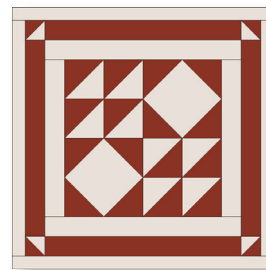

D10

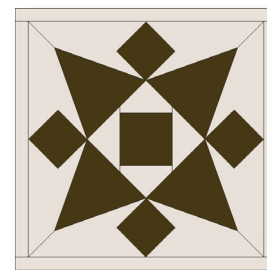

D11

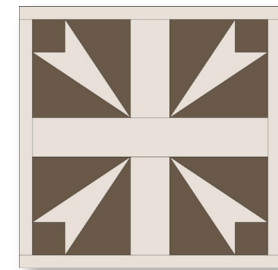

D12

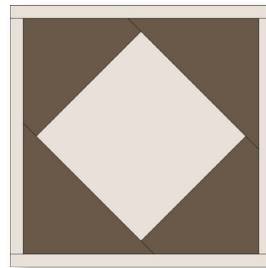

D13

The Jane Stickle Quilt - Block D1

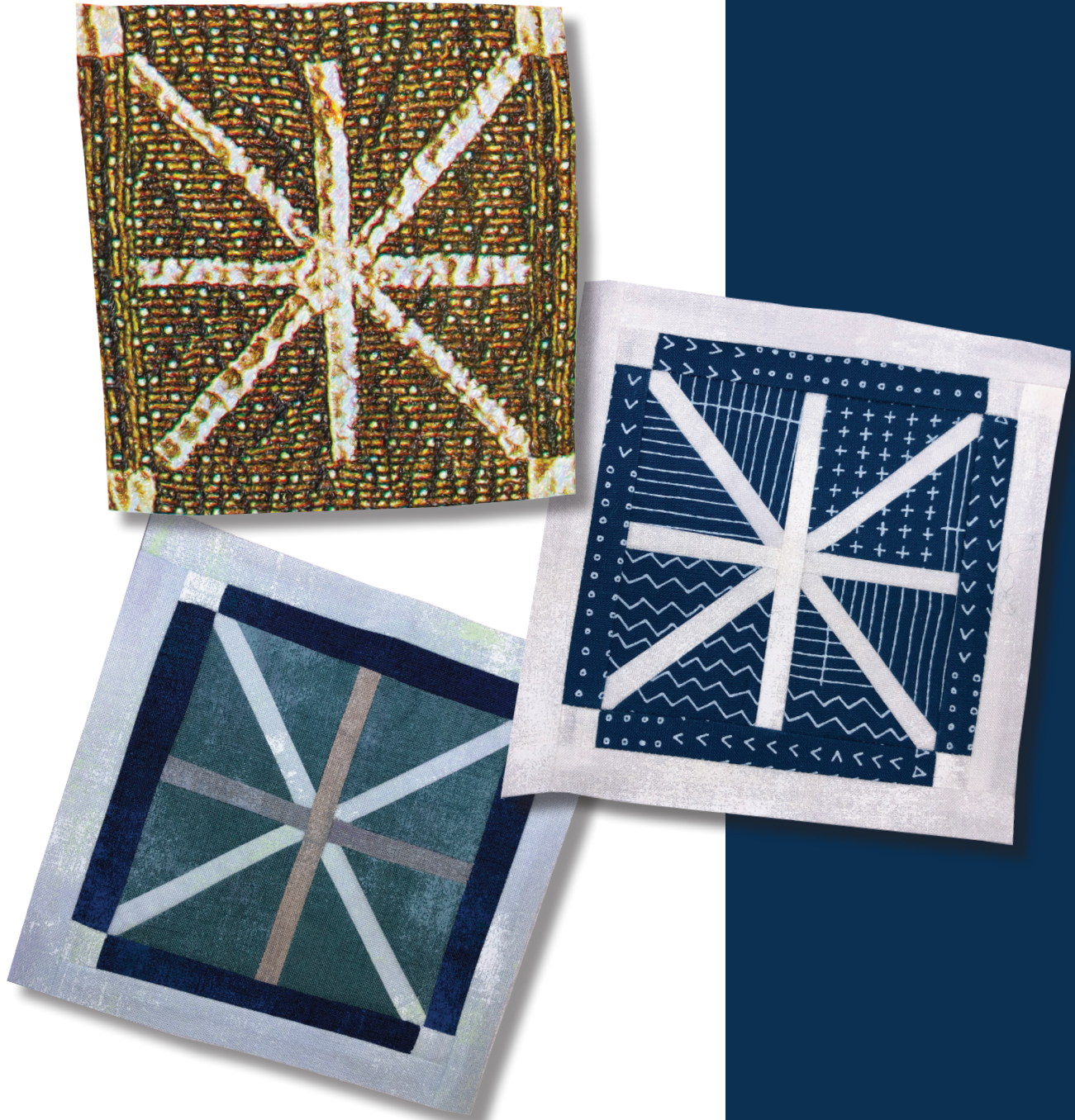

What you need:

| Patches | Quantity/size |
|---------|------------------------------------|
| A* | (2) 1" x 6" |
| B* | (2) 1" x 5" |
| C | (4) 1¼" x 1¼" |
| D | (4) 1¼" x 4½" |
| E | (4) 1¼" x 3½" |
| F | (4) 2¾" x 2¾", cut once diagonally |
| G | (2) 1¼" x 2½" |
| H | (1)(4) 1¼" x 4½" |

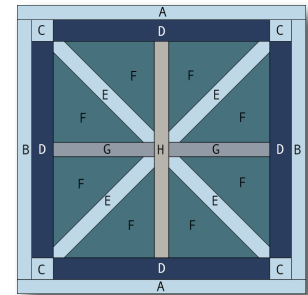

Hobbystash Colorway

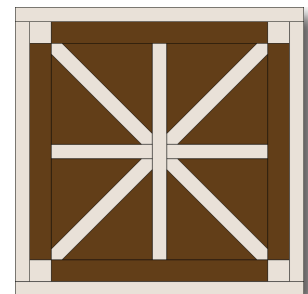

Jane Stickle Colorway

**The actual required width for Unit A and Unit B units is ¾". The increased width specified above allows for squaring the block to exactly 5½".*

Assembly:

1. Using the templates provided on Page D1-2, foundation piece each section.
2. Join the sections together.
3. Join Unit B to the right side of the block, and then the left.
4. Join Unit A to the top of the block and then the bottom. Square up block to measure 5½" x 5½"

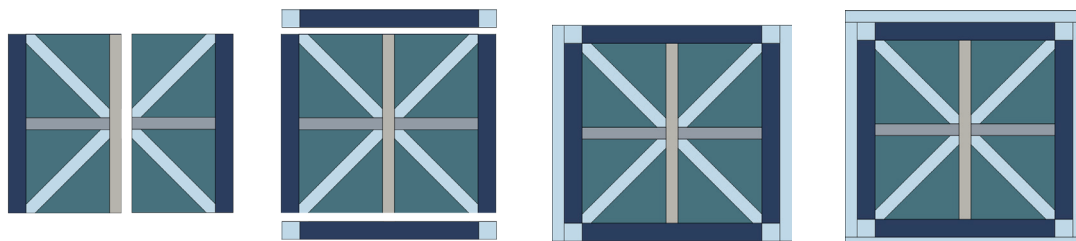

SET PRINTER TO "ACTUAL SIZE" WHEN PRINTING THIS PAGE.

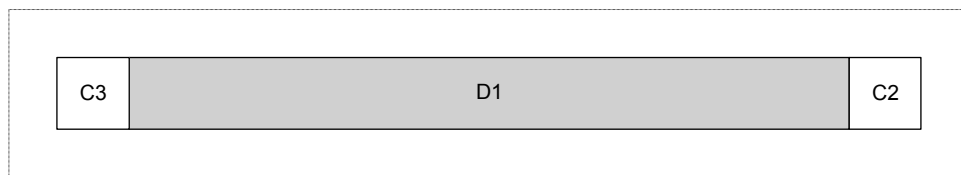
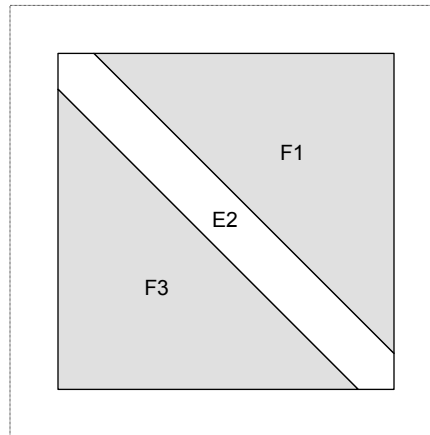
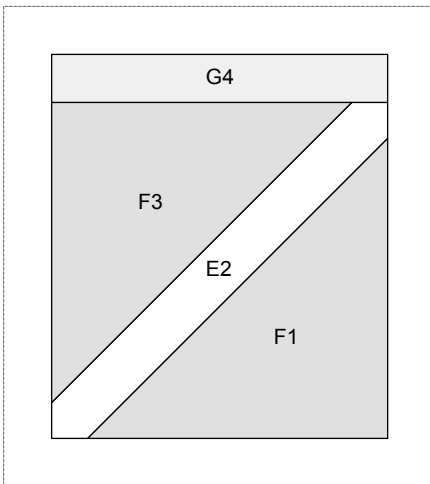
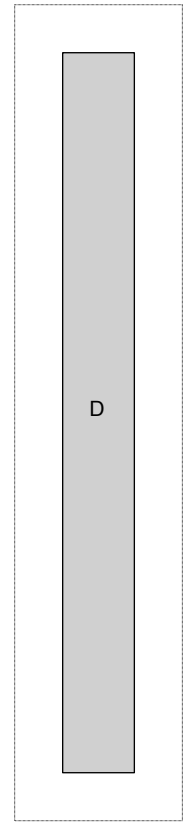
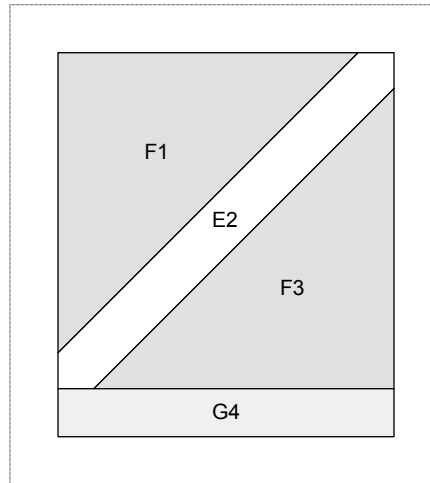
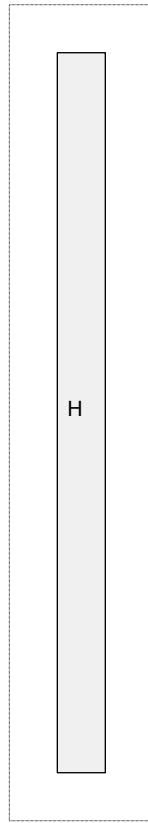
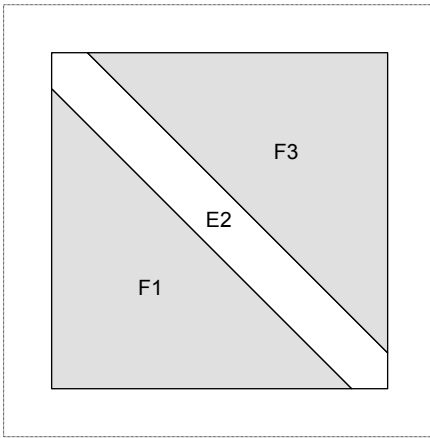
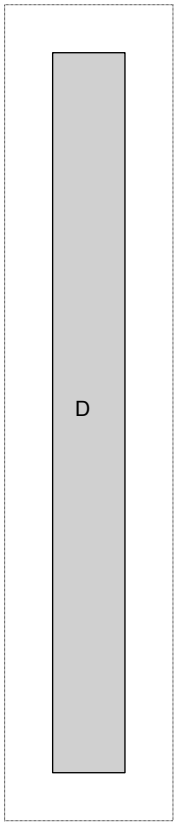
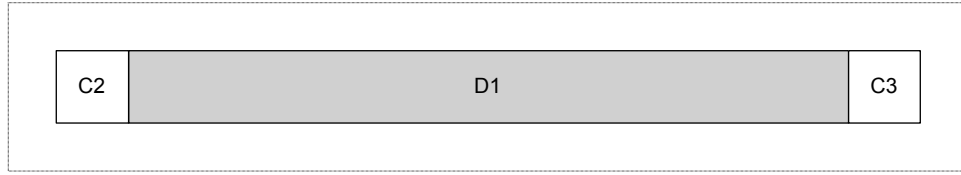

2"

SET PRINTER TO "ACTUAL SIZE" WHEN PRINTING THIS PAGE.

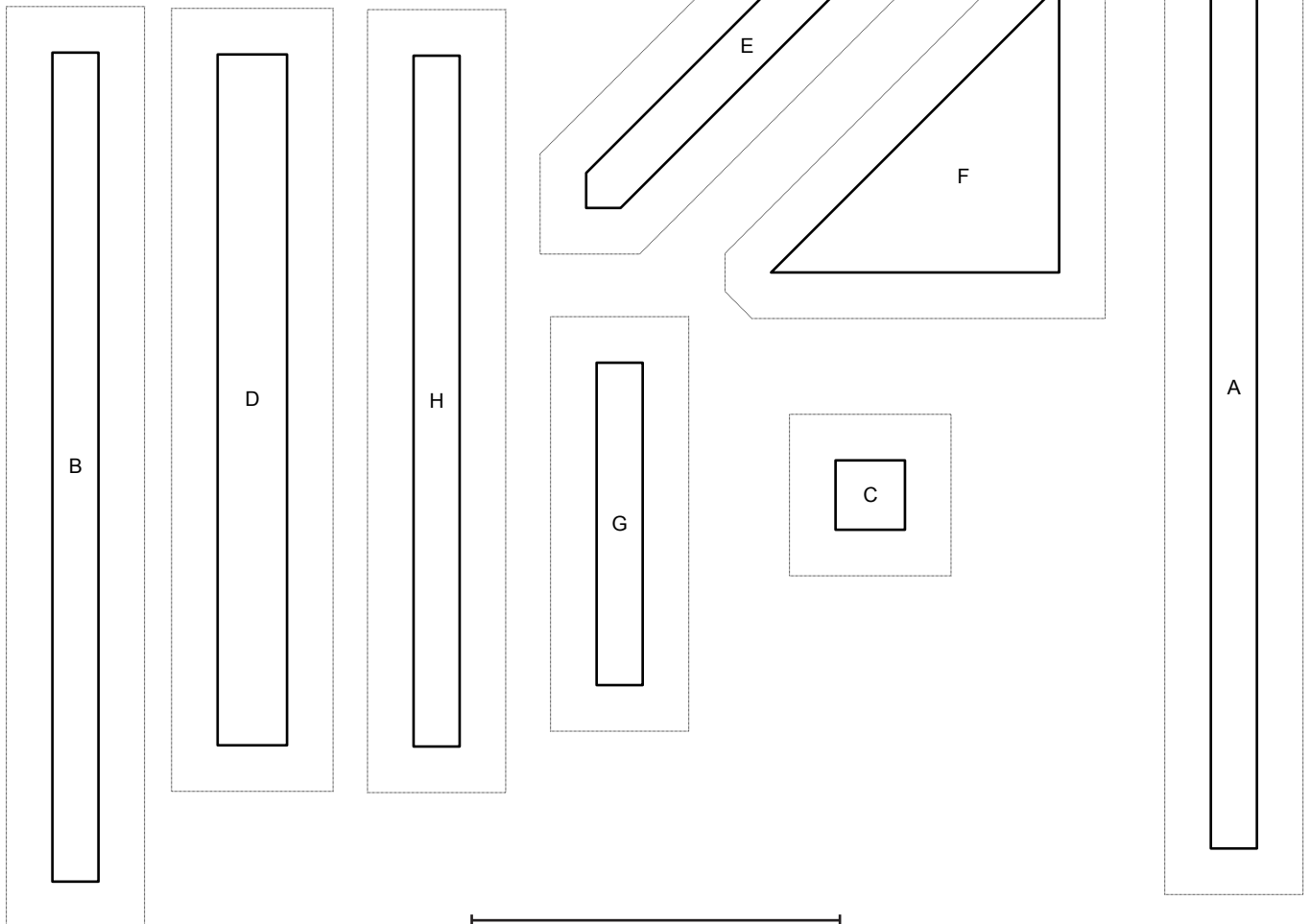
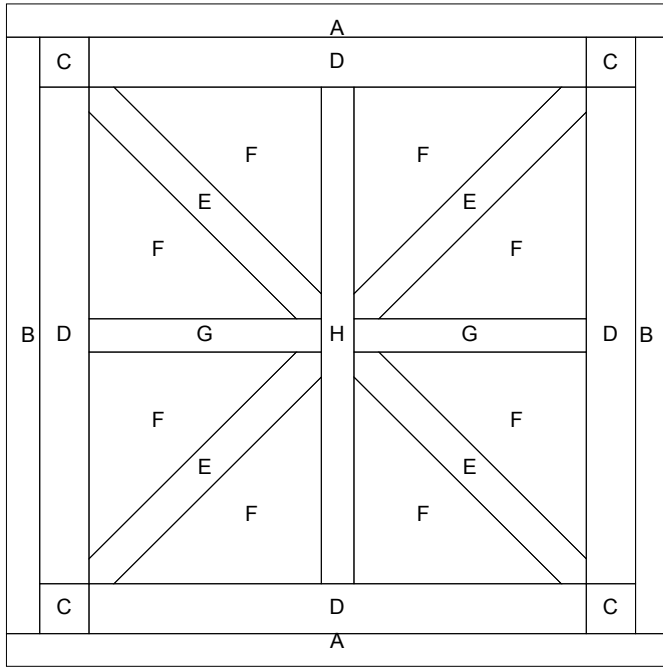

2"

The Jane Stickle Quilt - Block D2



What you need:

| Patches | Quantity/size |
|---------|--|
| A* | (2) 1" x 6" |
| B* | (2) 1" x 5" |
| C | (2) 1¾" x 1¾" - navy, cut once diagonally (2) 1¾" x 1¾" - green, cut once diagonally (2) 1¾" x 1¾" - light blue, cut once diagonally |
| D | (2) 1¾" x 3½" |
| E | (2) 1¾" x 2½" |
| F | (2) 1¾" x 2½" |
| G | (2) 1¾" x 3½" |
| H | (1) 2" x 2", cut twice diagonally |
| I | (4) 2½" x 2½" |
| J | (1) 1¼" x 1¼" |

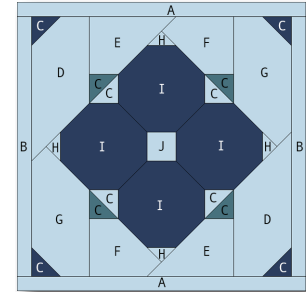

Hobby Stash Colorway

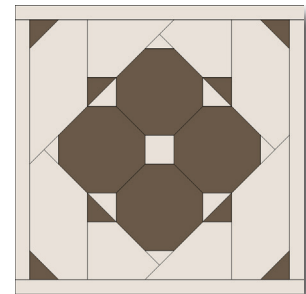

Jane Stickle Colorway

**The actual required width for Unit A and Unit B units is ¾". The increased width specified above allows for squaring the block to exactly 5½".*

Assembly:

- Using the templates provided on Page D2-2, foundation piece each section.
- Join the four Unit I sections together to form a cloverleaf.
- Join the four light blue Unit C sections to the cloverleaf using inset seaming.
- Join the remaining outer corner sections to the cloverleaf.
- Reverse appliqué the center Unit J to the block.
- Join Unit B to the right side of the block, and then the left.
- Join Unit A to the top of the block and then the bottom. Square up block to measure 5½" x 5½"

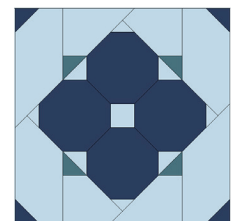
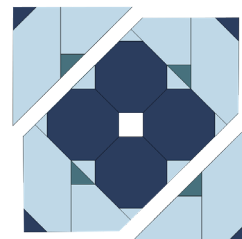
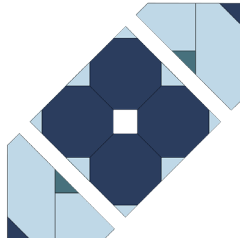
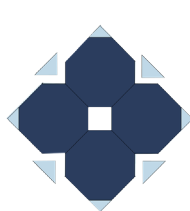
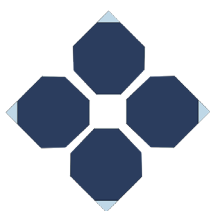

SET PRINTER TO "ACTUAL SIZE" WHEN PRINTING THIS PAGE.

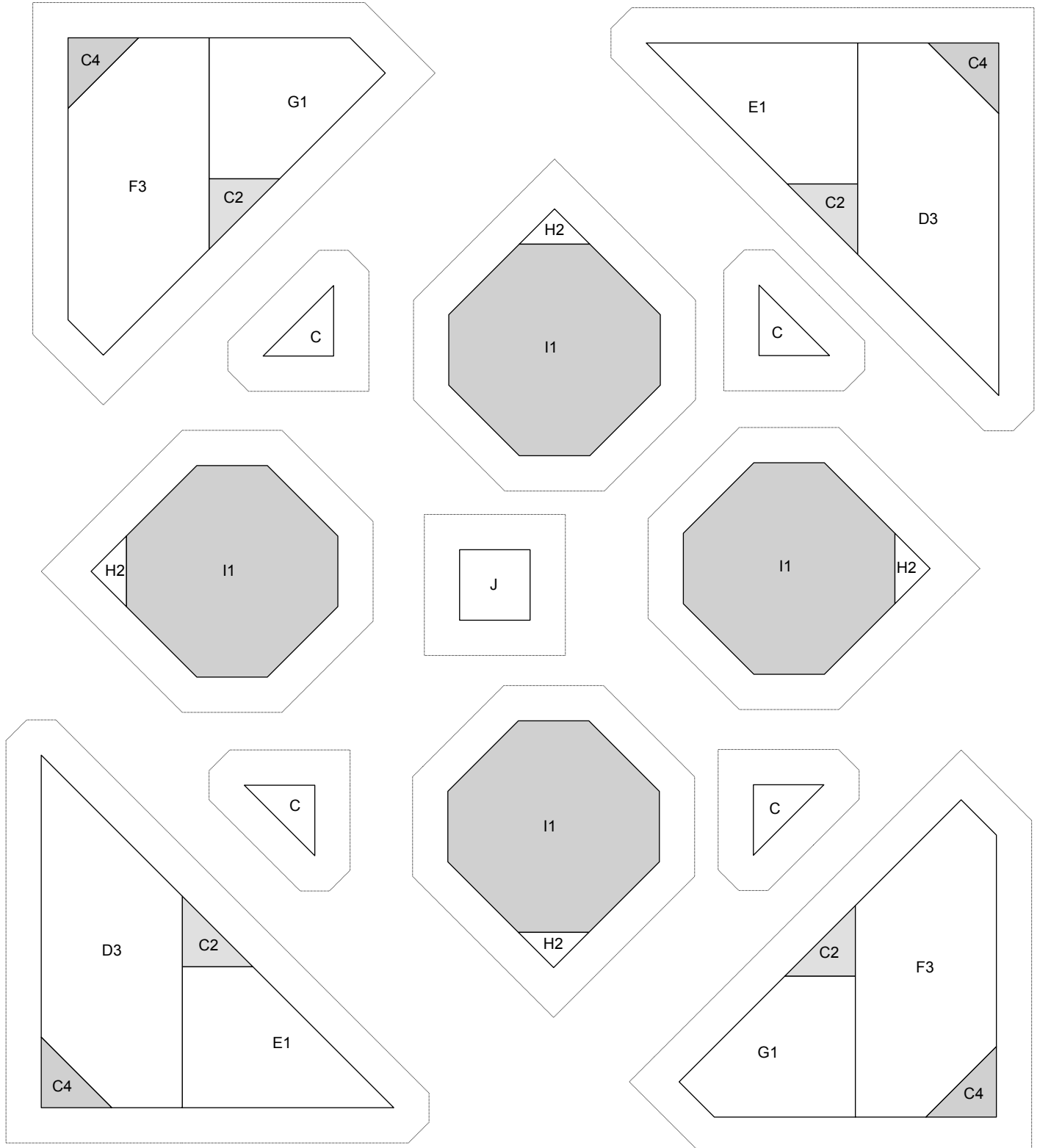

2"

SET PRINTER TO "ACTUAL SIZE" WHEN PRINTING THIS PAGE.

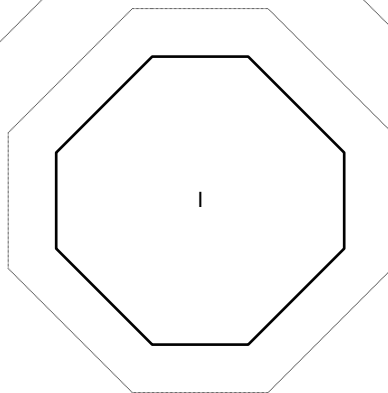
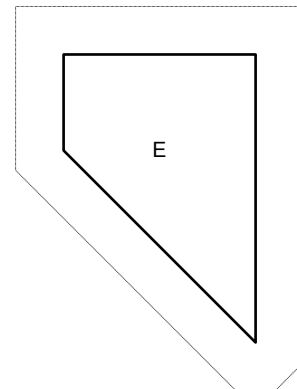
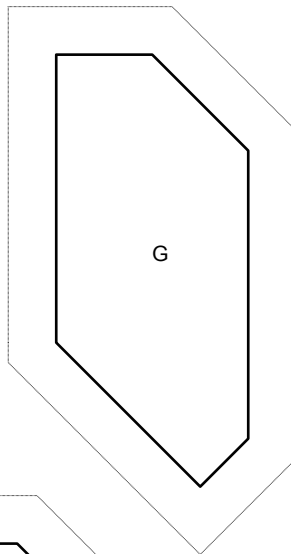
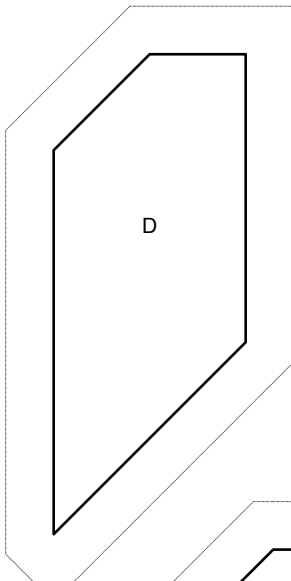
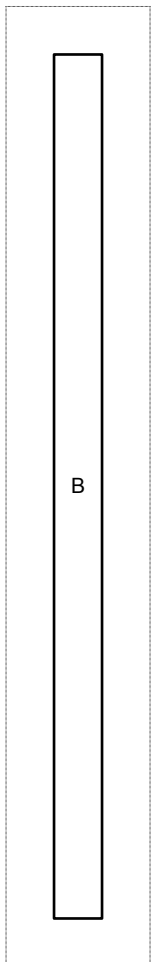
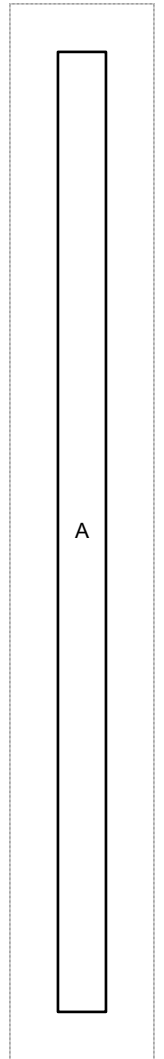
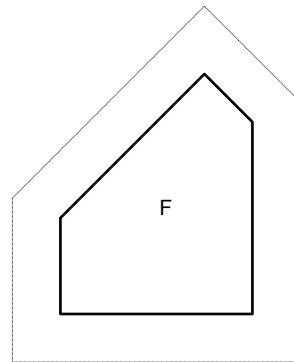
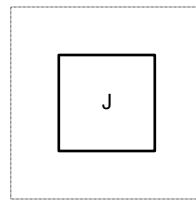
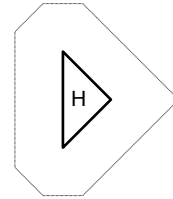
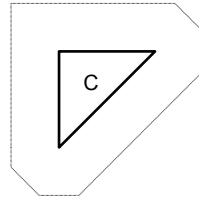
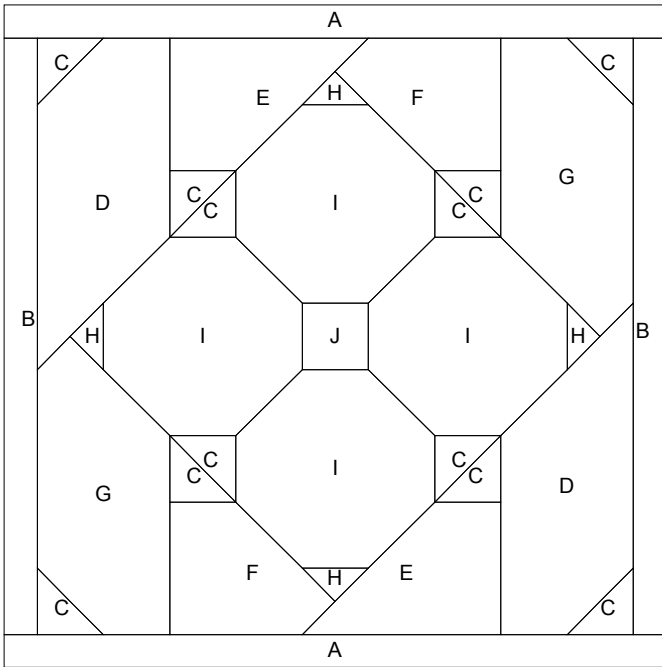

2"

The Jane Stickle Quilt - Block D3



What you need:

| Patches | Quantity/size |
|---------|---------------|
| A* | (2) 1" x 6" |
| B* | (2) 1" x 5" |
| C | (1) 6" x 6" |
| D | (1) 4" x 4" |

**The actual required width for Unit A and Unit B units is ¾". The increased width specified above allows for squaring the block to exactly 5½".*

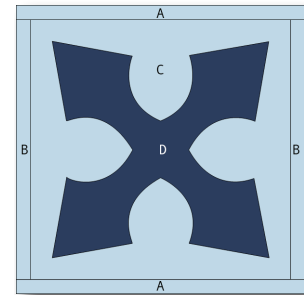

Hobbystash Colorway

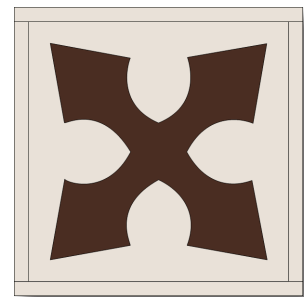

Jane Stickle Colorway

Assembly:

1. Using the template provided on page D3-2, appliqué the arrow unit to Unit C. Trim the block to 5" x 5" square.
2. Join Unit B to the right side of the block, and then the left.
3. Join Unit A to the top of the block and then the bottom. Square up block to measure 5½" x 5½".

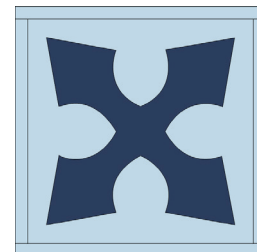
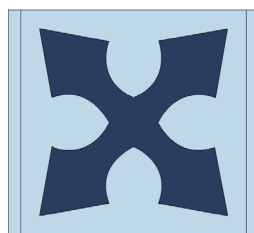

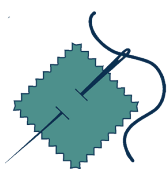

SET PRINTER TO "ACTUAL SIZE" WHEN PRINTING THIS PAGE.

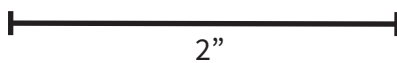
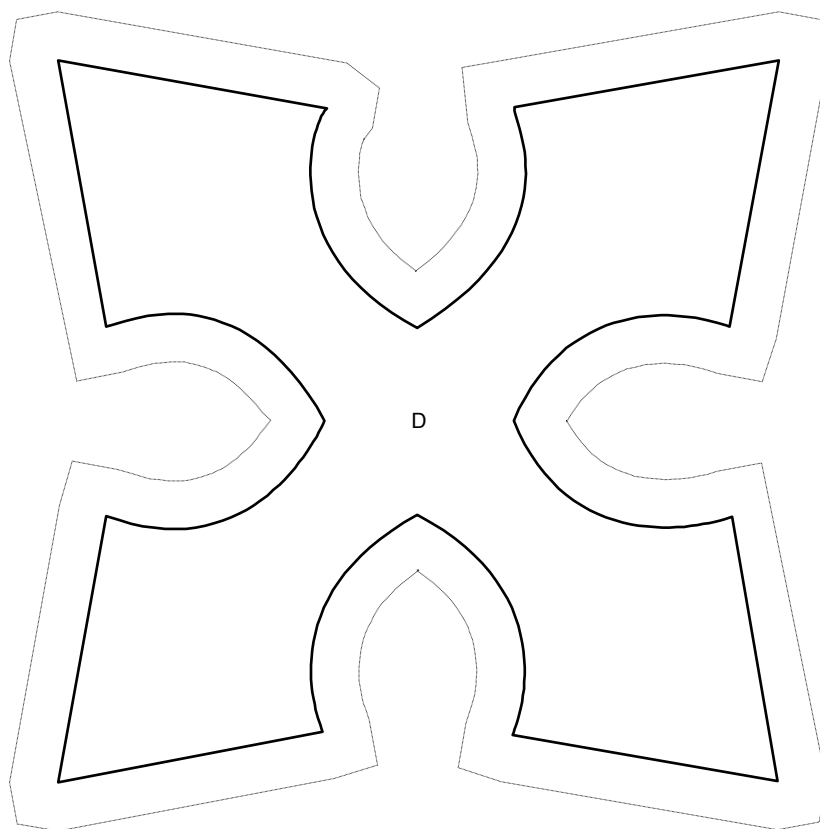

SET PRINTER TO "ACTUAL SIZE" WHEN PRINTING THIS PAGE.

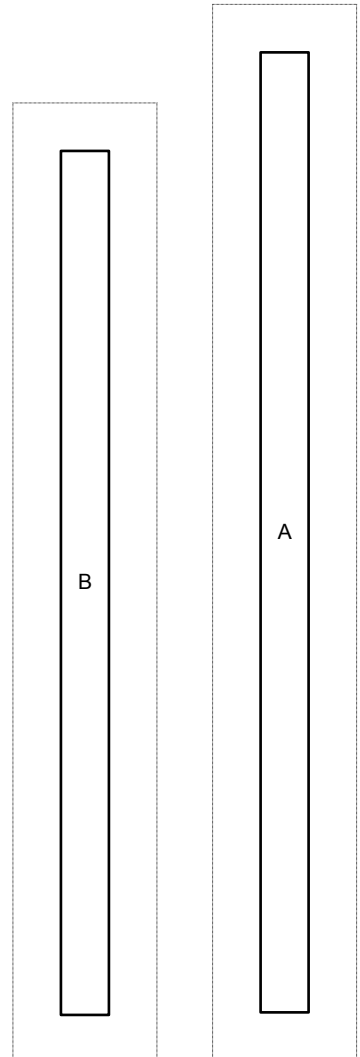
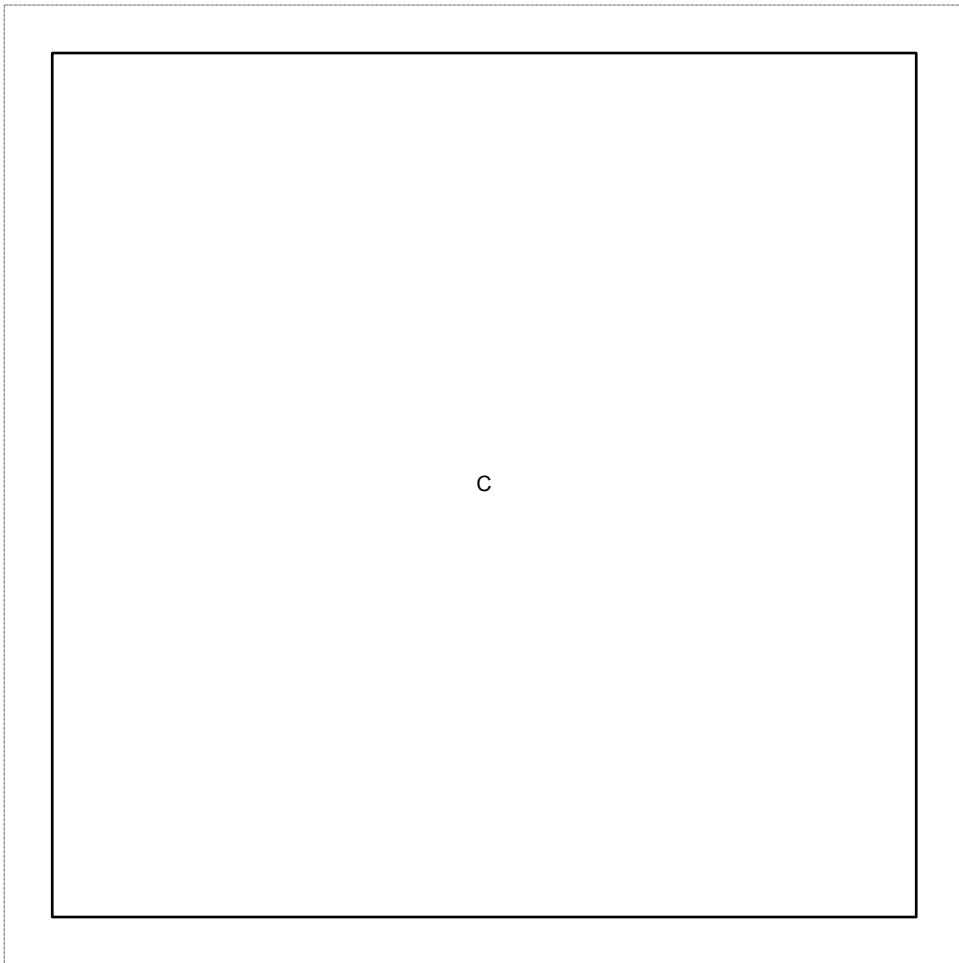
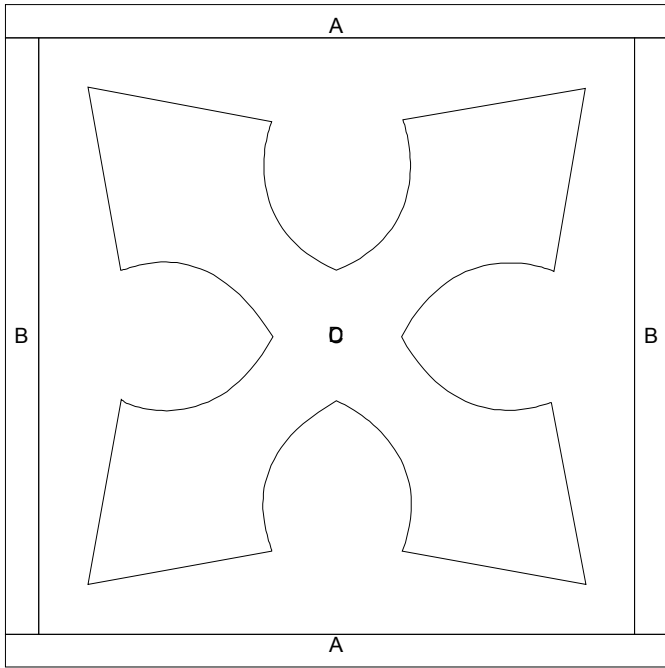

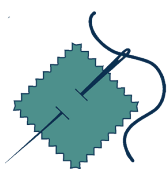

SET PRINTER TO "ACTUAL SIZE" WHEN PRINTING THIS PAGE.

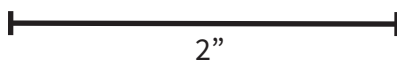
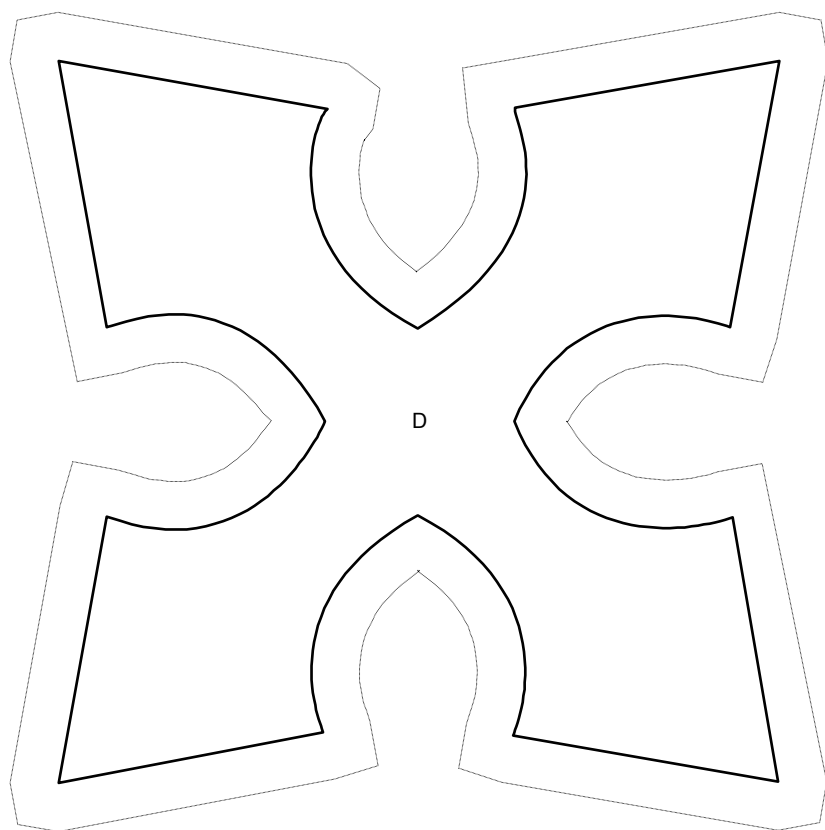

The Jane Stickle Quilt - Block D4



What you need:

| Patches | Quantity/size |
|---------|---------------|
| A* | (2) 1" x 6" |
| B* | (2) 1" x 5" |
| C | (4) 1¾" x 1¾" |
| D | (4) 2" x 2" |
| E | (4) 2" x 2" |
| F | (4) 2" x 2" |
| G | (1) 3" x 3" |
| H | (4) 1¾" x 2" |

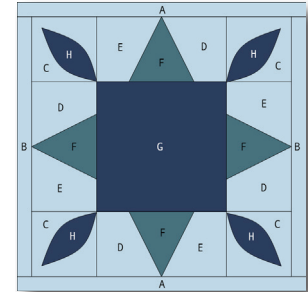

Hobbystash Colorway

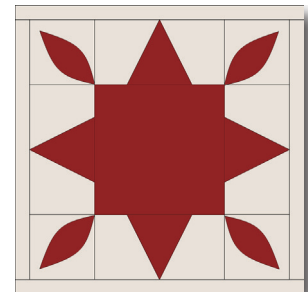

Jane Stickle Colorway

**The actual required width for Unit A and Unit B units is ¾". The increased width specified above allows for squaring the block to exactly 5½".*

Assembly:

1. Using the templates provided on Page D4-2, foundation piece each section.
2. Join the sections together.
3. Applique the four Unit H melon pieces to the block.
4. Join Unit B to the right side of the block, and then the left.
5. Join Unit A to the top of the block and then the bottom. Square up block to measure 5½" x 5½"

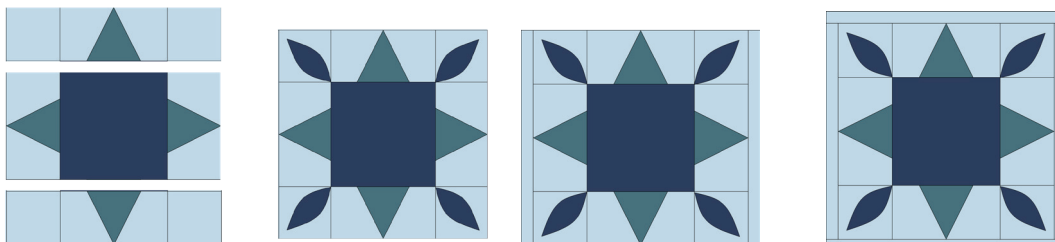

SET PRINTER TO "ACTUAL SIZE" WHEN PRINTING THIS PAGE.

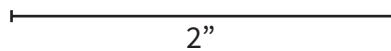
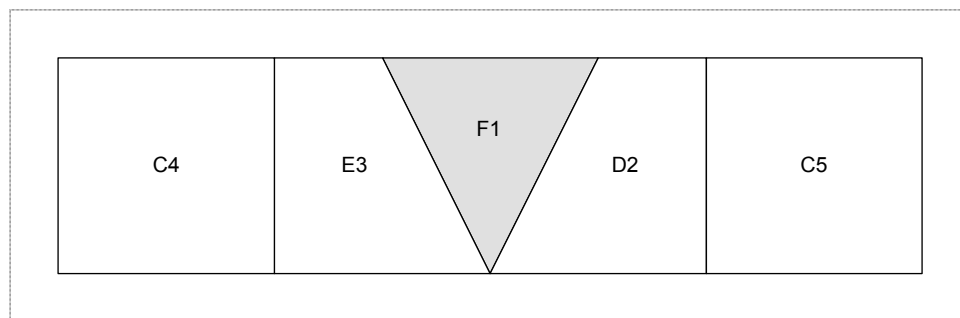
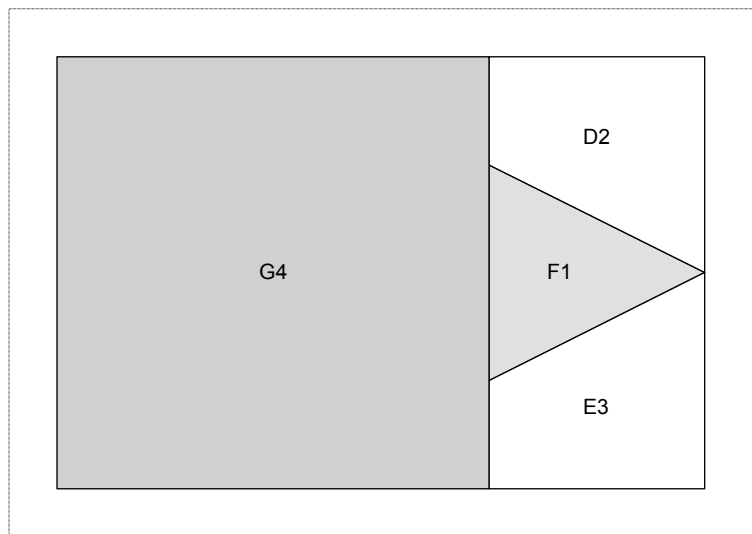
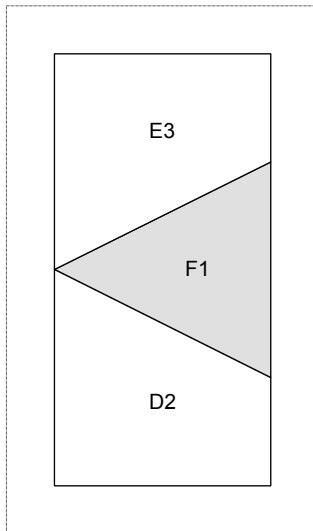
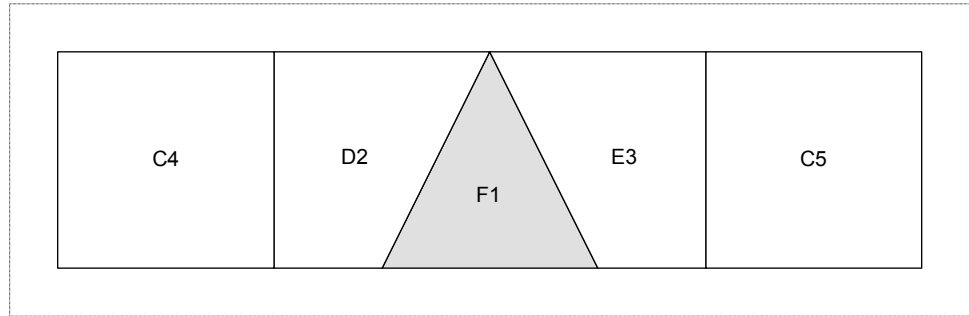
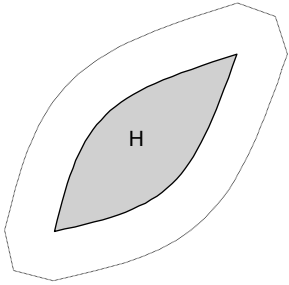

SET PRINTER TO "ACTUAL SIZE" WHEN PRINTING THIS PAGE.

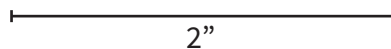
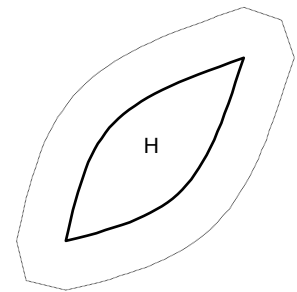
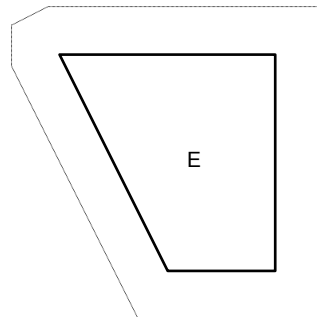
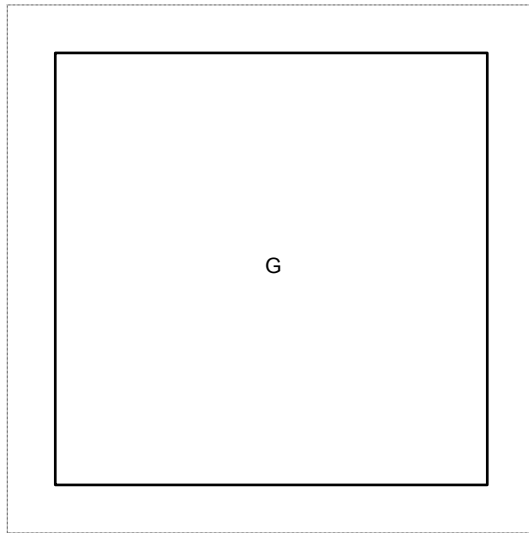
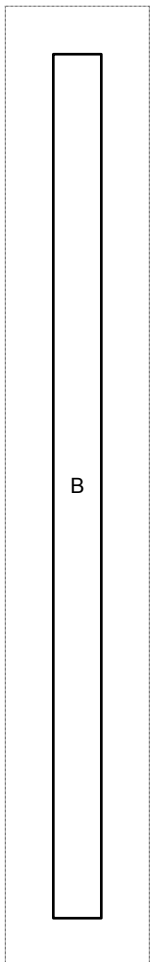
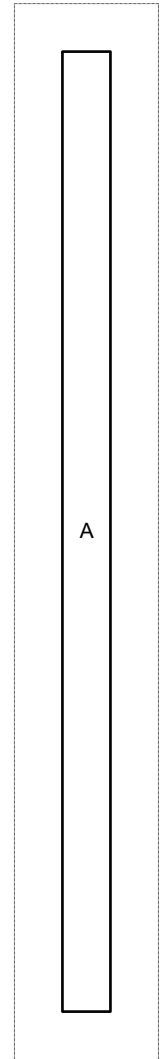
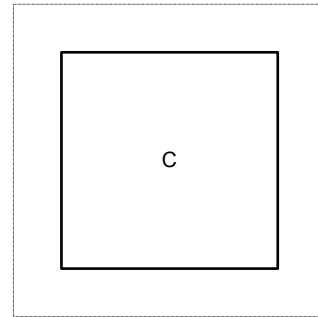
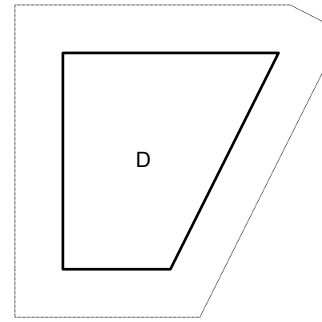
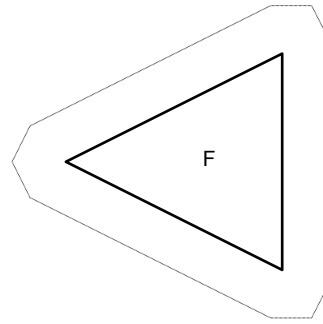
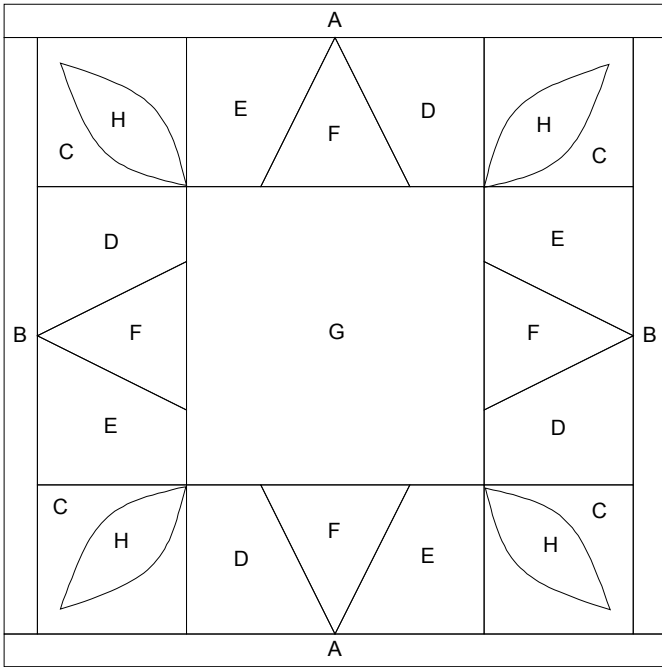

The Jane Stickle Quilt - Block D5

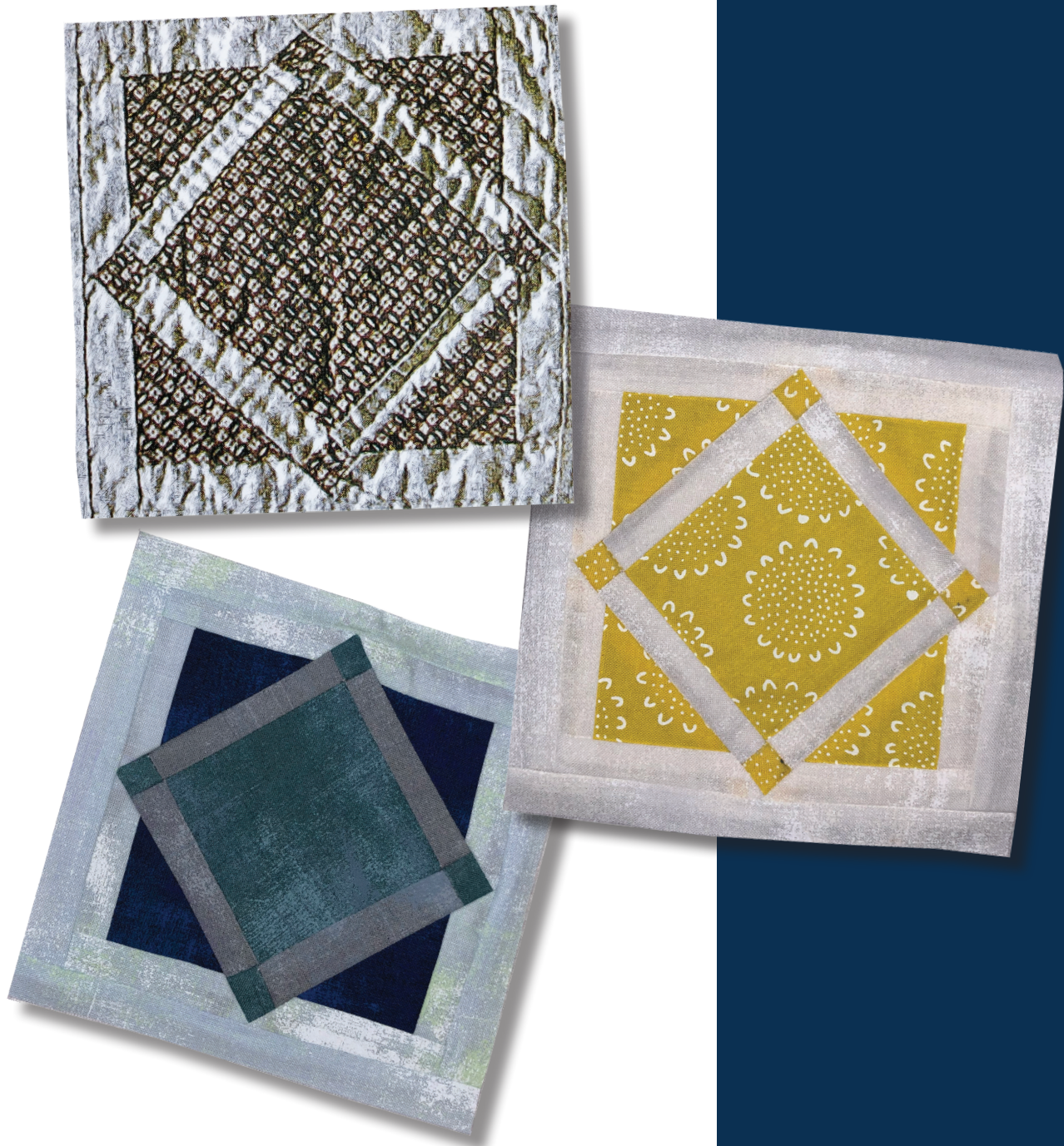

What you need:

| Patches | Quantity/size |
|---------|------------------------------------|
| A* | (2) 1" x 6" |
| B* | (2) 1" x 5" |
| C | (2) 1¼" x 3¼" |
| D | (2) 1¼" x 3¼" |
| E | (2) 1¼" x 3" |
| F | (2) 1¼" x 3" |
| G | (2) 2¾" x 2¾", cut once diagonally |
| H | (4) 1¼" x 1¼" |
| I | (4) 1¼" x 3¼" |
| J | (1) 3¼" x 3¼" |

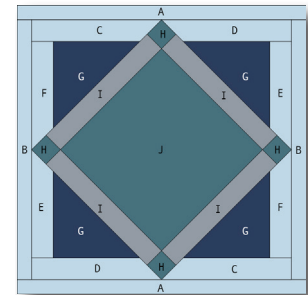

Hobbystash Colorway

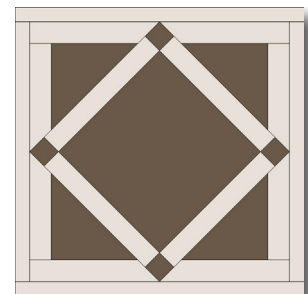

Jane Stickle Colorway

**The actual required width for Unit A and Unit B units is ¾". The increased width specified above allows for squaring the block to exactly 5½".*

Assembly:

1. Using the templates provided on Page D5-2, foundation piece each section.
2. Join the sections together.
3. Join Unit B to the right side of the block, and then the left.
4. Join Unit A to the top of the block and then the bottom. Square up block to measure 5½" x 5½"

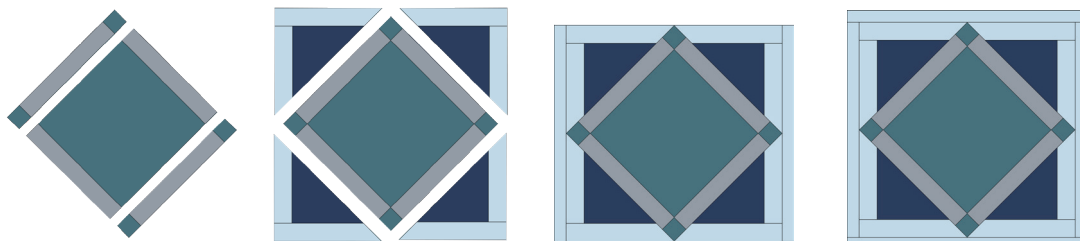

SET PRINTER TO "ACTUAL SIZE" WHEN PRINTING THIS PAGE.

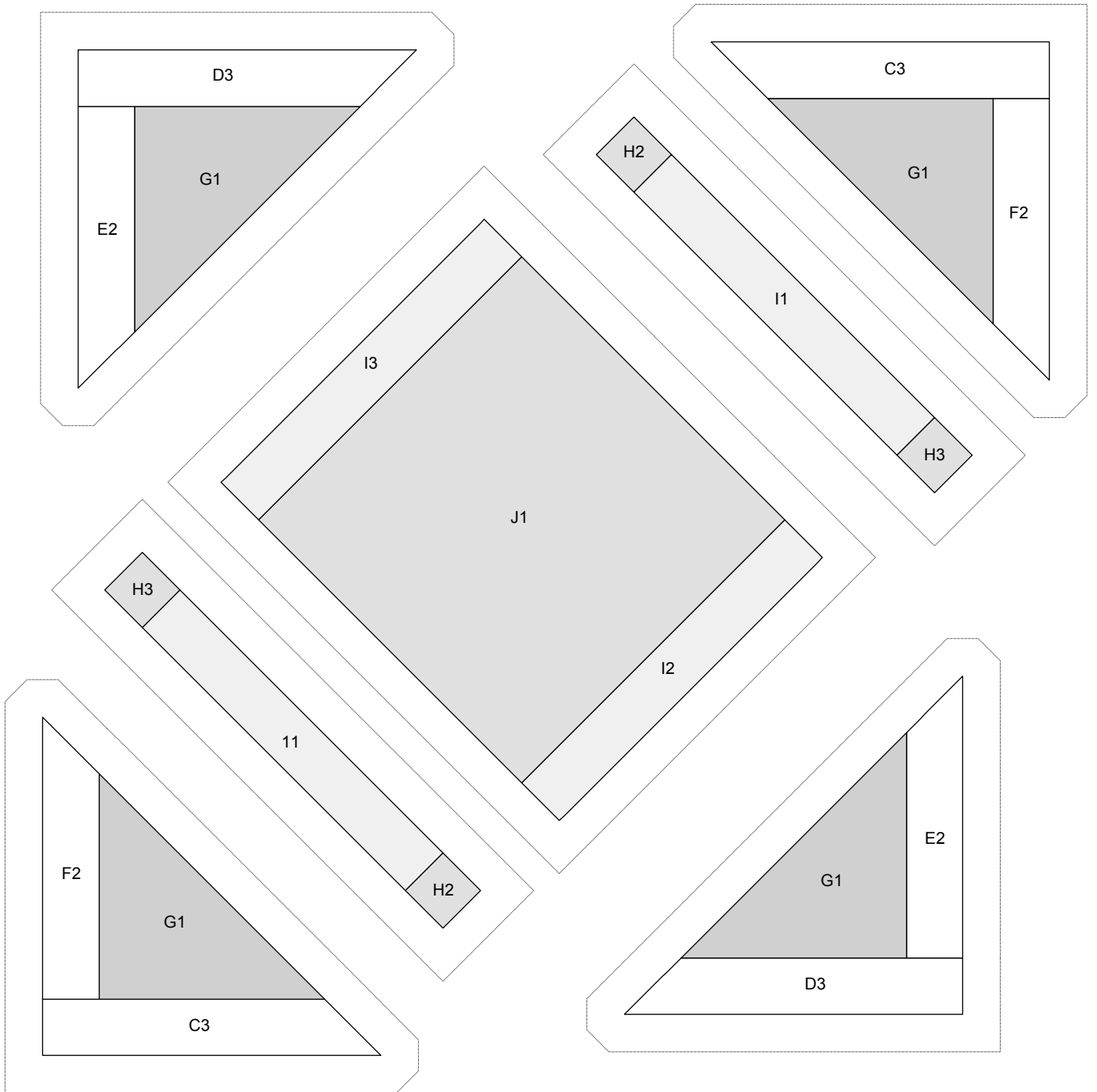

2"

SET PRINTER TO "ACTUAL SIZE" WHEN PRINTING THIS PAGE.

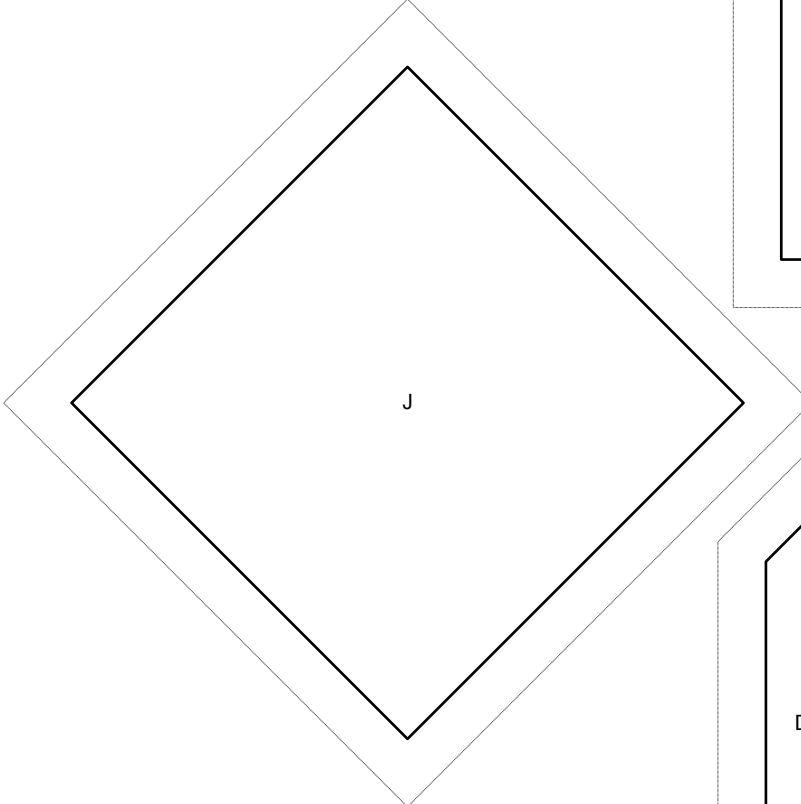
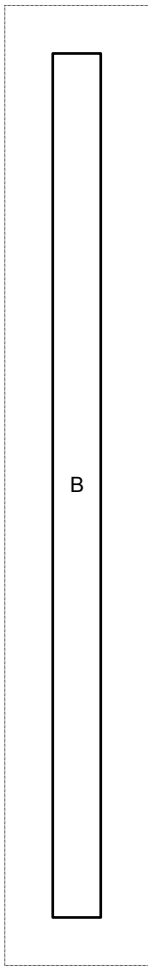
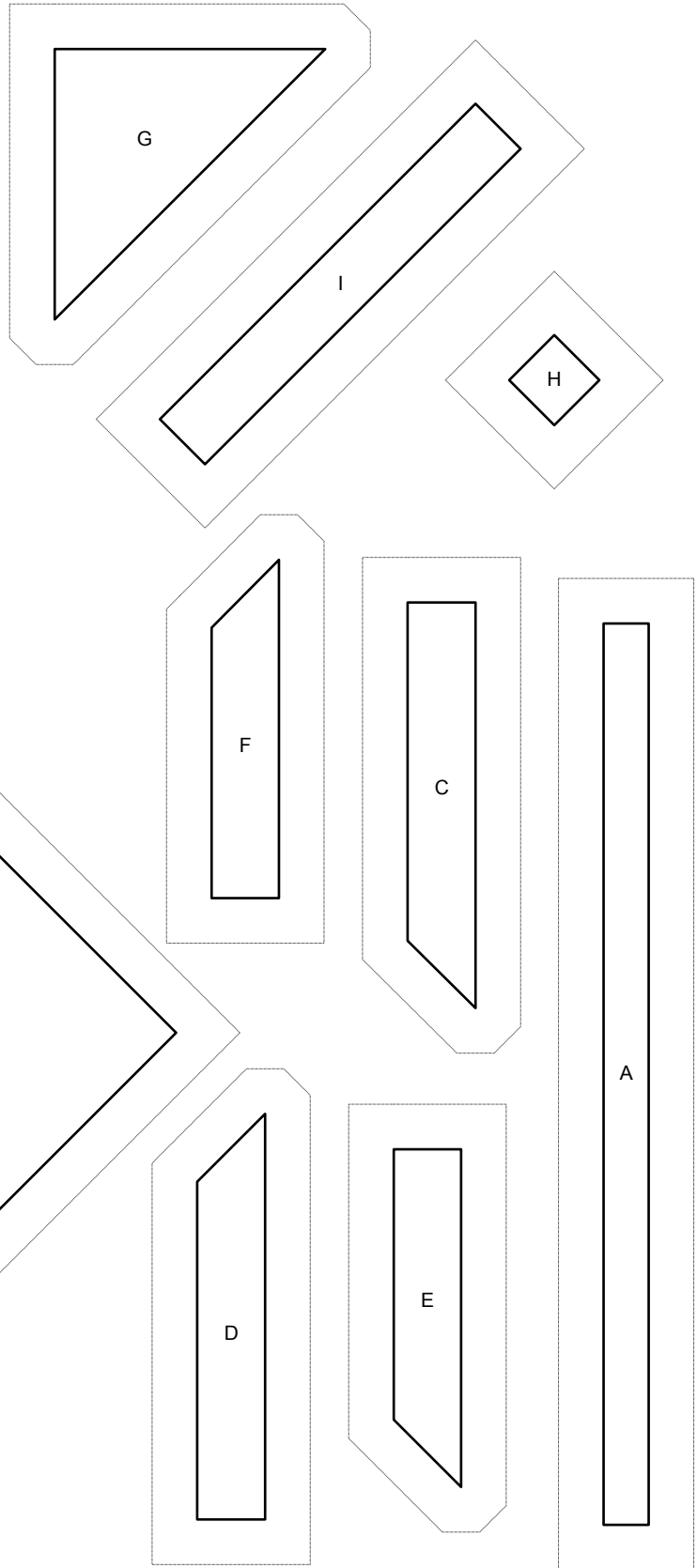
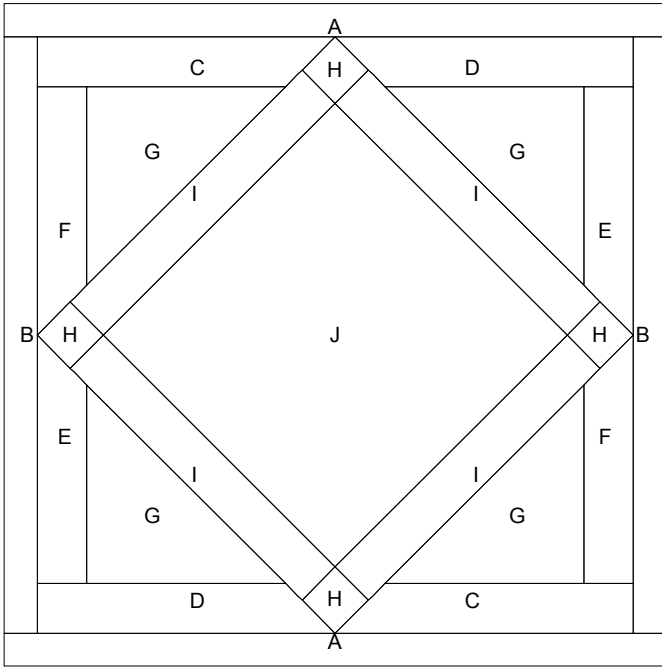

2"

The Jane Stickle Quilt - Block D6

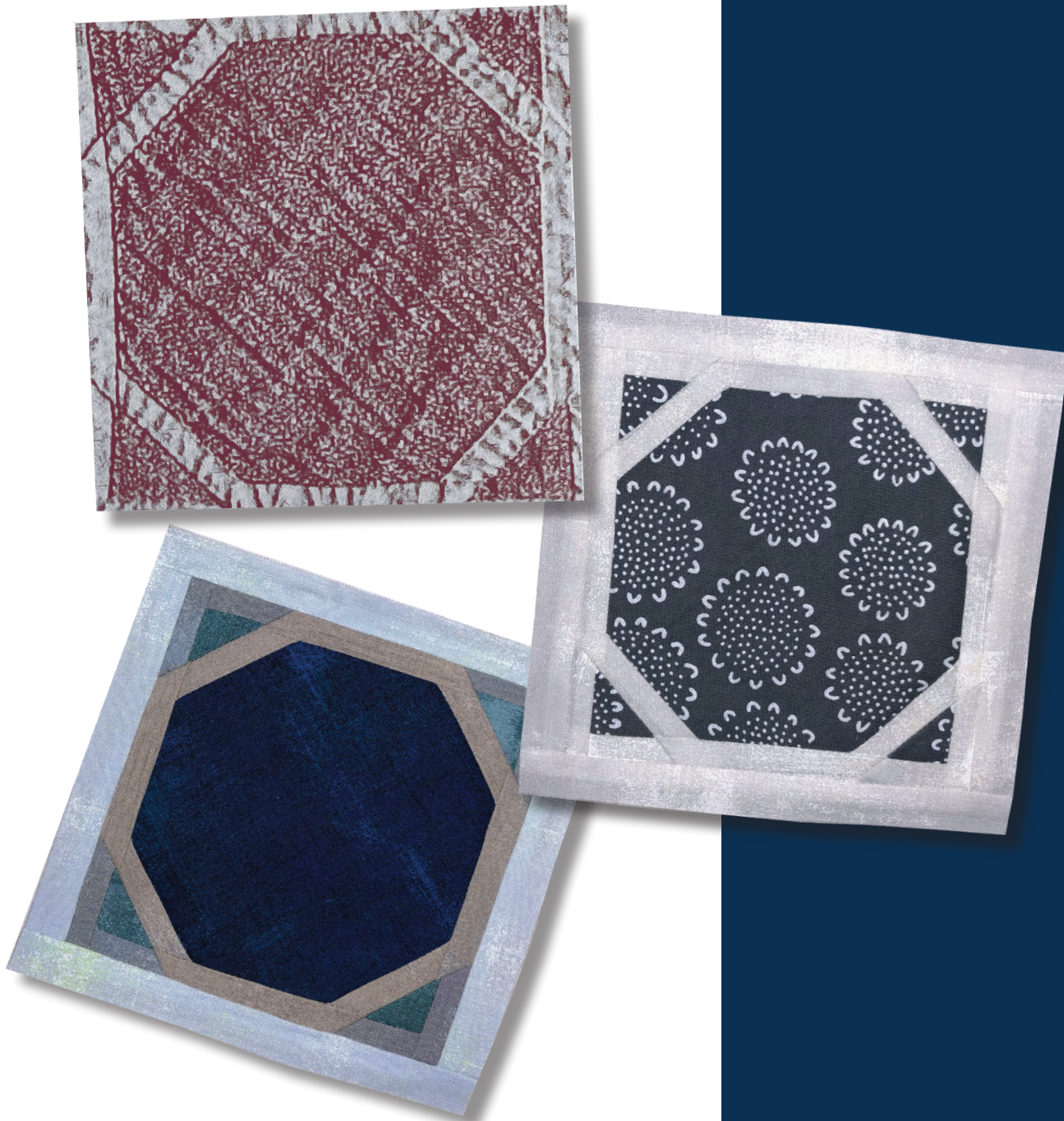

What you need:

| Patches | Quantity/size |
|---------|----------------------------------|
| A* | (2) 1" x 6" |
| B* | (2) 1" x 5" |
| C | (2) 1" x 2½" |
| D | (2) 1" x 2½" |
| E | (4) 1" x 4" |
| F | (2) 1" x 2½" |
| G | (2) 1" x 2½" |
| H | (2) 2" x 2", cut once diagonally |
| I | (4) 1" x 3" |
| J | (1) 5" x 5" |

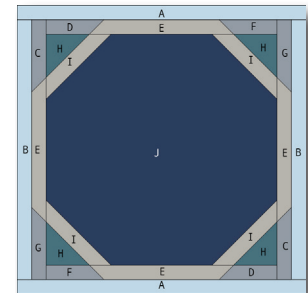

Hobbystash Colorway

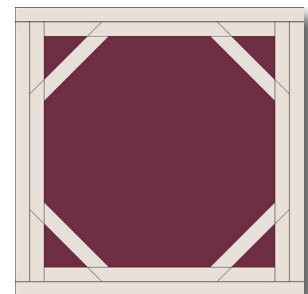

Jane Stickle Colorway

**The actual required width for Unit A and Unit B units is ¾". The increased width specified above allows for squaring the block to exactly 5½".*

Assembly:

1. Using the templates provided on Page D6-2, foundation piece each section.
2. Join the sections together.
3. Join Unit B to the right side of the block, and then the left.
4. Join Unit A to the top of the block and then the bottom. Square up block to measure 5½" x 5½"

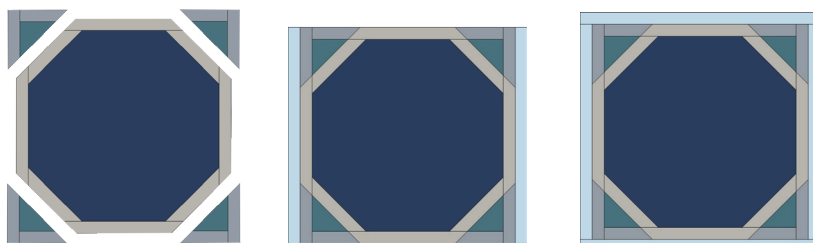

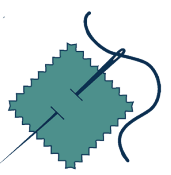

SET PRINTER TO "ACTUAL SIZE" WHEN PRINTING THIS PAGE.

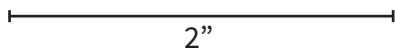
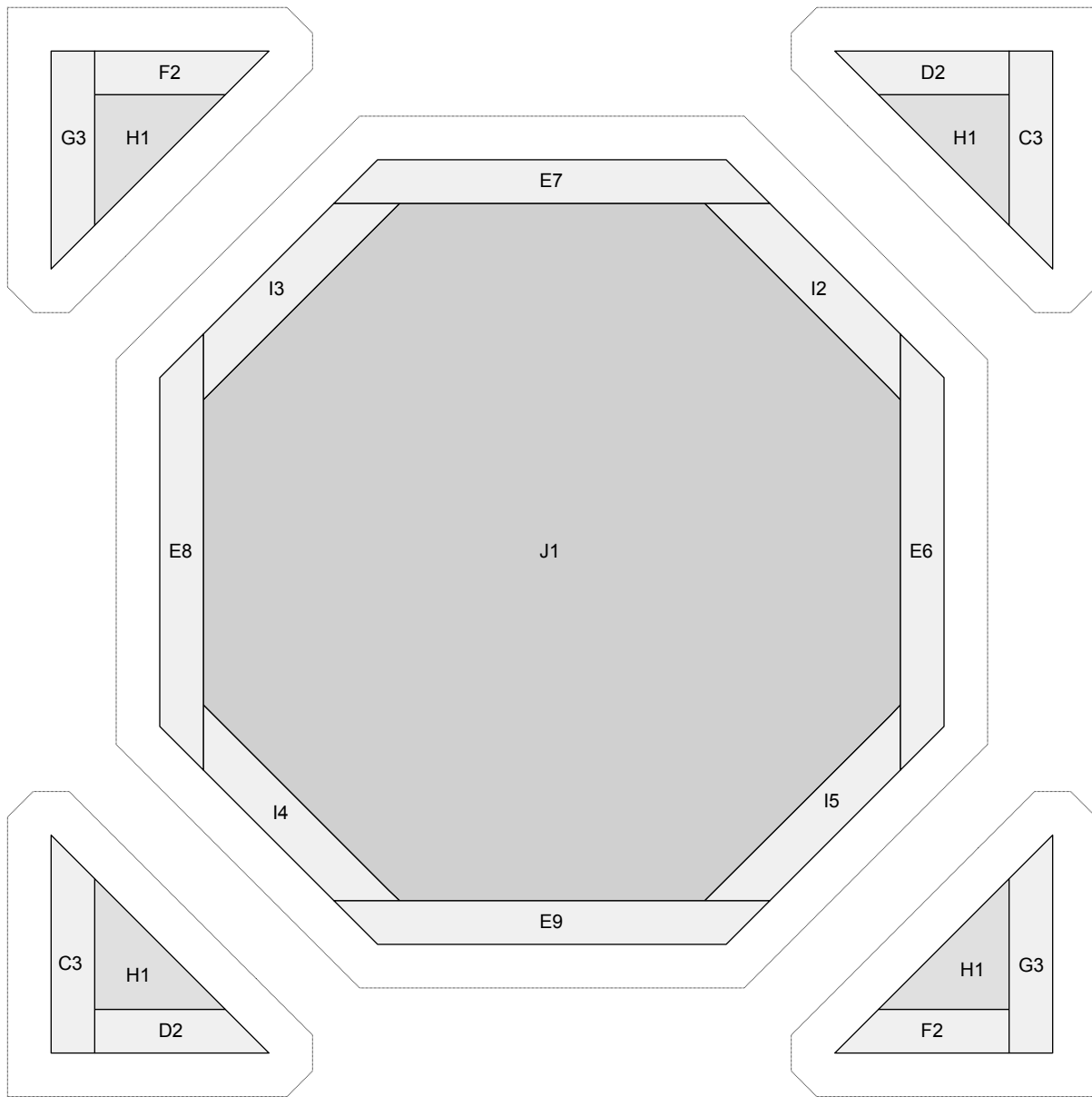

SET PRINTER TO "ACTUAL SIZE" WHEN PRINTING THIS PAGE.

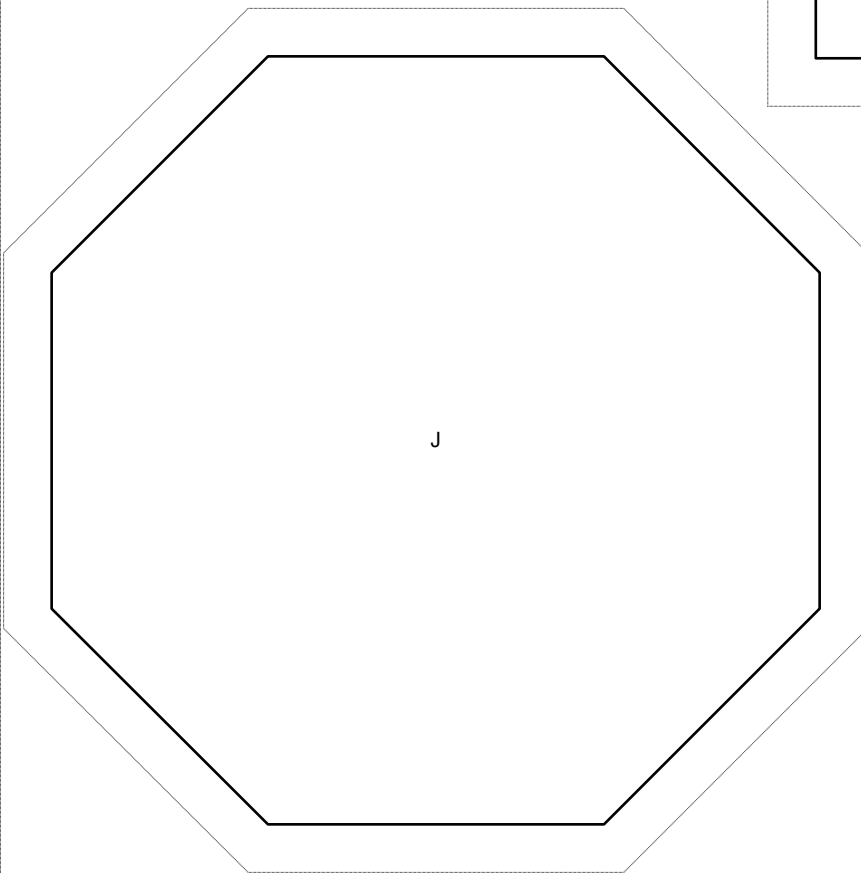
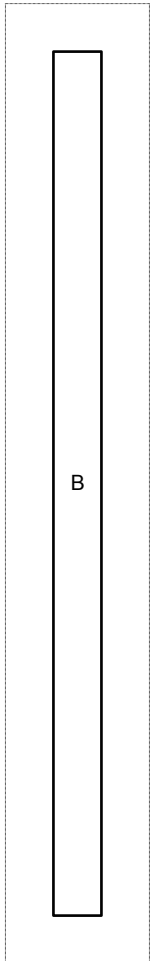
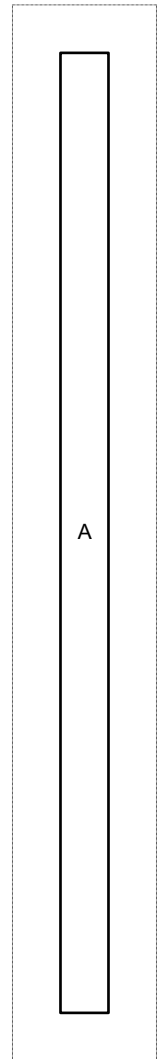
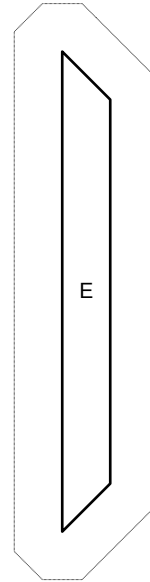
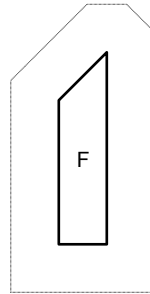
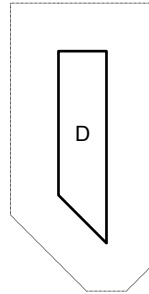
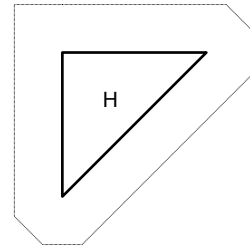
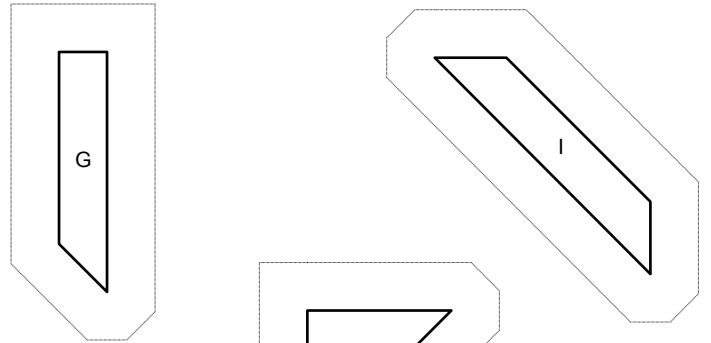
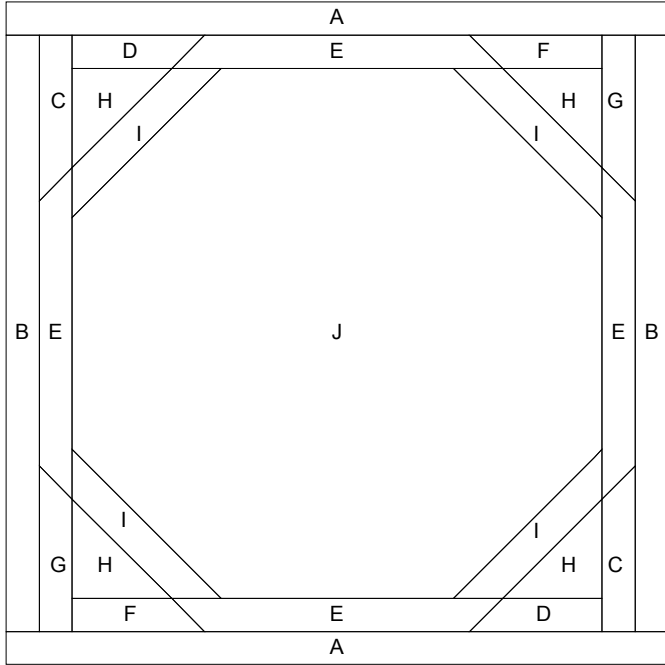

2"

The Jane Stickle Quilt - Block D7

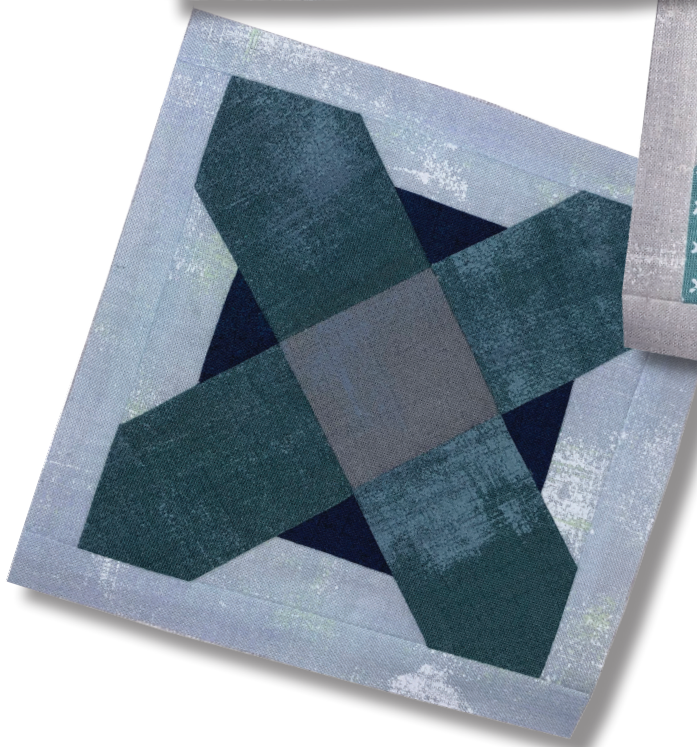

What you need:

| Patches | Quantity/size |
|---------|-------------------------------------|
| A* | (2) 1" x 6" |
| B* | (2) 1" x 5" |
| C | (4) 4" x 4" |
| D | (4) 1½" x 3¾" |
| E | (1) 2½" x 2½" |
| F | (1) 2¾" x 2¾", cut twice diagonally |

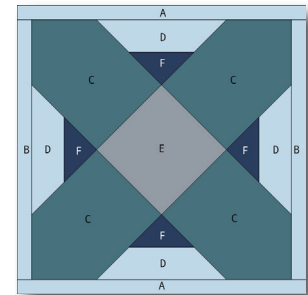

Hobbystash Colorway

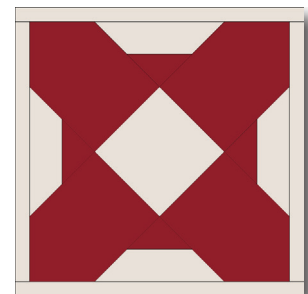

Jane Stickle Colorway

**The actual required width for Unit A and Unit B units is ¾". The increased width specified above allows for squaring the block to exactly 5½".*

Assembly:

1. Using the templates provided on Page D7-2, foundation piece each section.
2. Join the sections together.
3. Join Unit B to the right side of the block, and then the left.
4. Join Unit A to the top of the block and then the bottom. Square up block to measure 5½" x 5½"

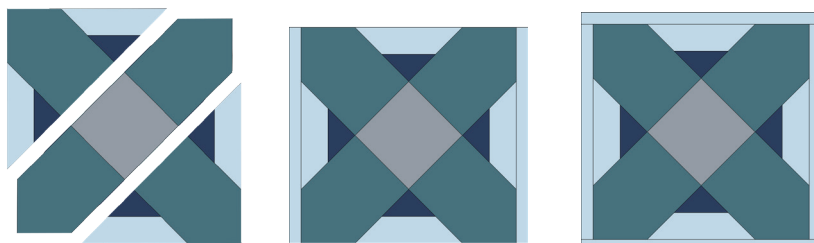

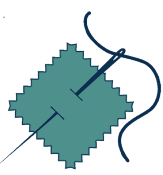

SET PRINTER TO "ACTUAL SIZE" WHEN PRINTING THIS PAGE.

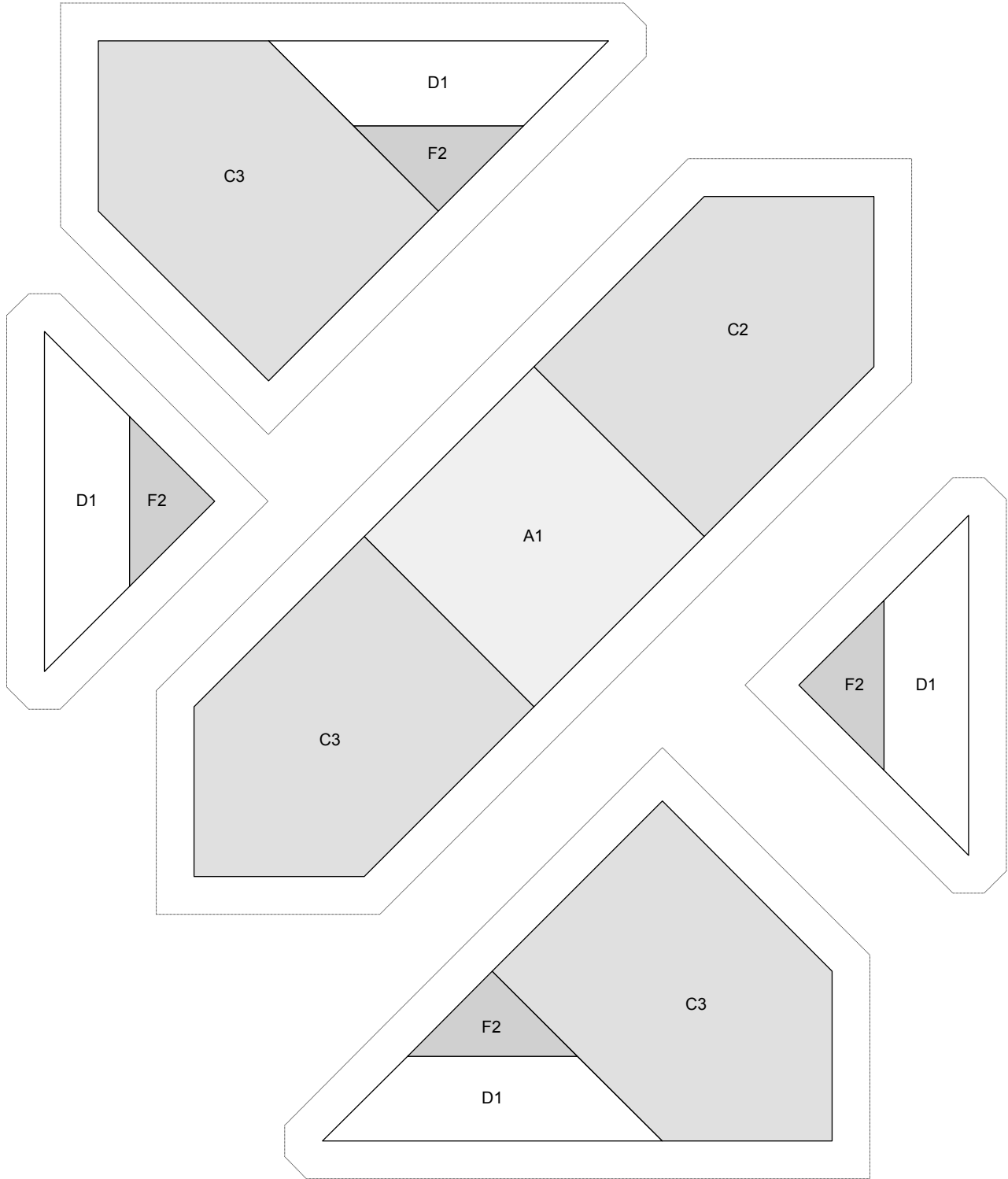

2"

SET PRINTER TO "ACTUAL SIZE" WHEN PRINTING THIS PAGE.

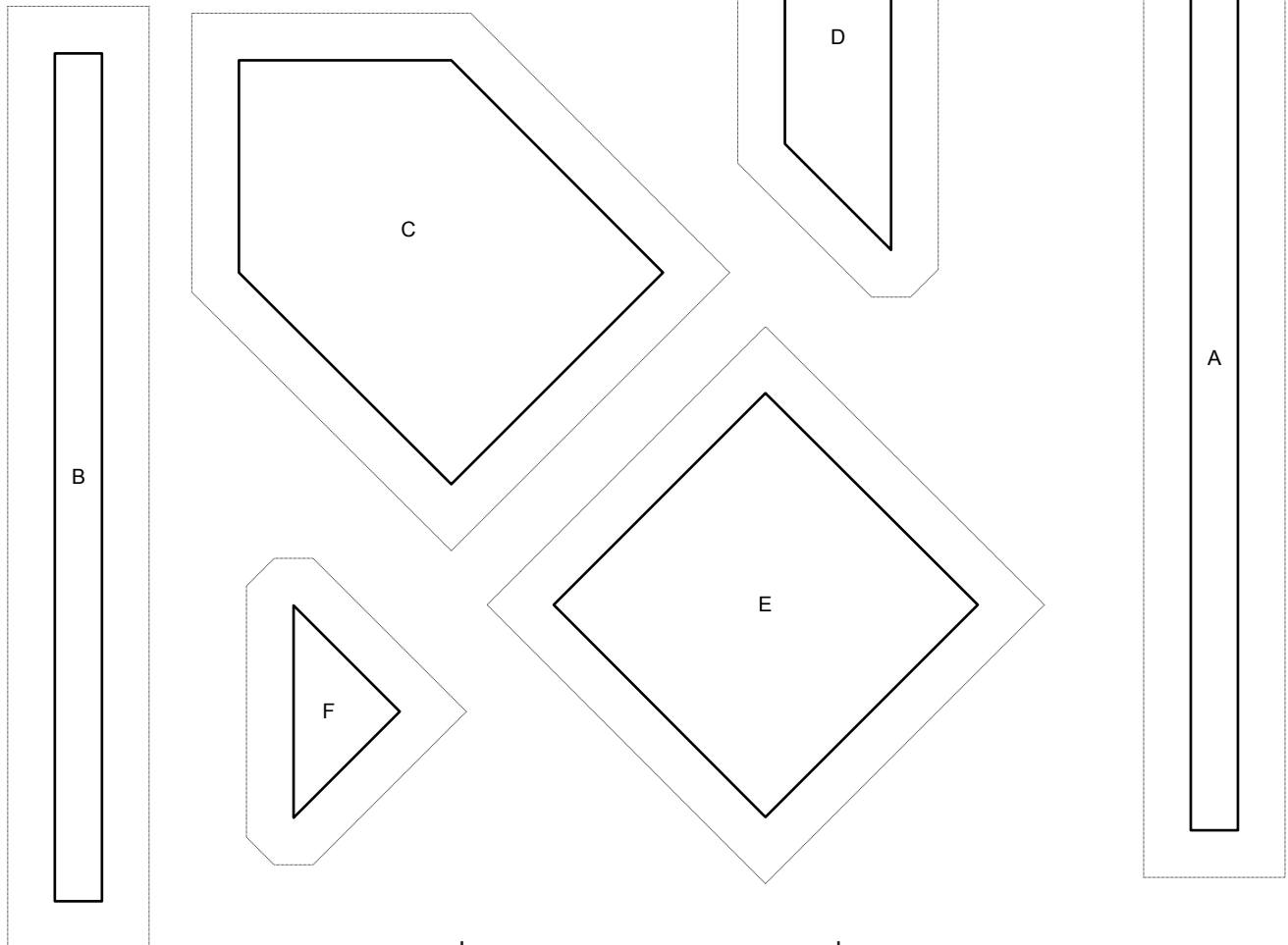
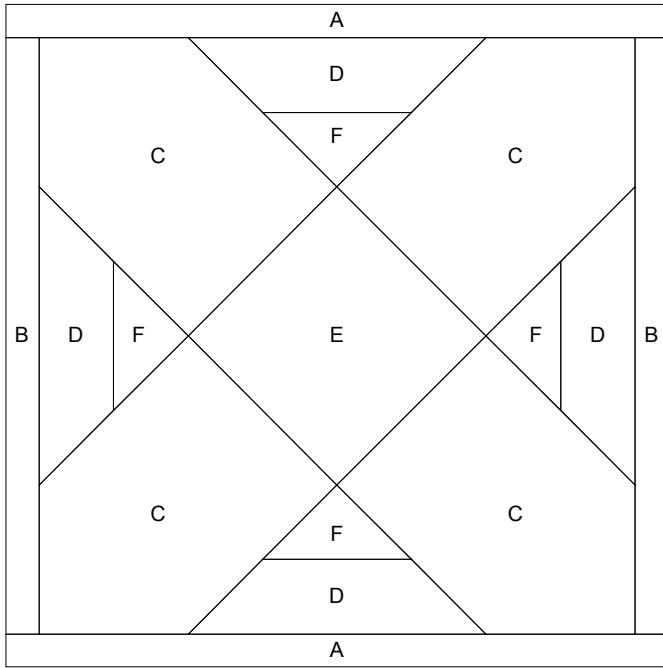

2"

The Jane Stickle Quilt - Block D8



What you need:

| Patches | Quantity/size |
|---------|---------------|
| A* | (2) 1" x 6" |
| B* | (2) 1" x 5" |
| C | (1) 6" x 6" |
| D | (4) 1½" x 2" |
| E | (4) 1½" x 2" |

**The actual required width for Unit A and Unit B units is ¾". The increased width specified above allows for squaring the block to exactly 5½".*

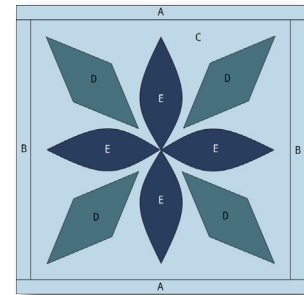

Hobbystash Colorway

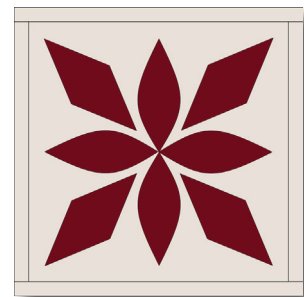

Jane Stickle Colorway

Assembly:

1. Using the templates provided on page D8-2, appliqué the melon and diamond units to Unit C. Trim the block to 5" x 5" square.
2. Join Unit B to the right side of the block, and then the left.
3. Join Unit A to the top of the block and then the bottom. Square up block to measure 5½" x 5½".

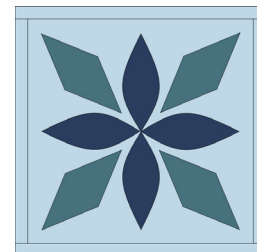
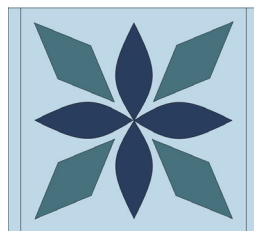

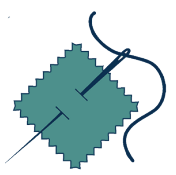

SET PRINTER TO "ACTUAL SIZE" WHEN PRINTING THIS PAGE.

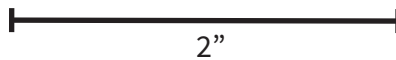
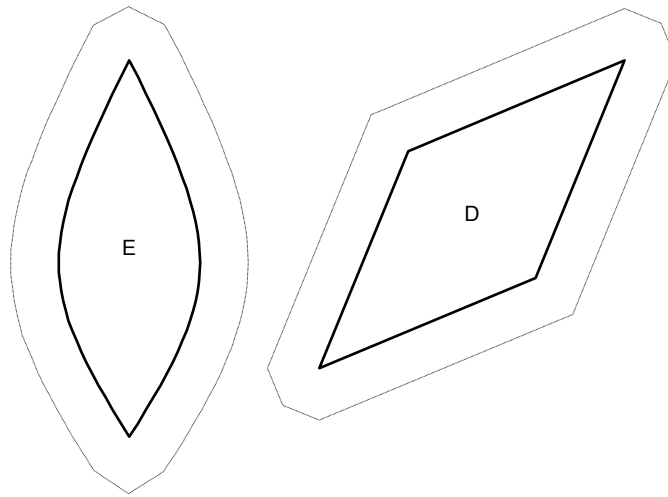

SET PRINTER TO "ACTUAL SIZE" WHEN PRINTING THIS PAGE.

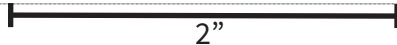
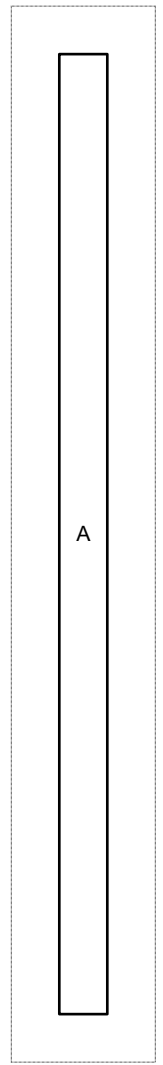
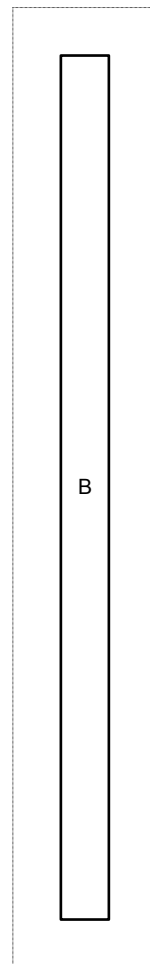
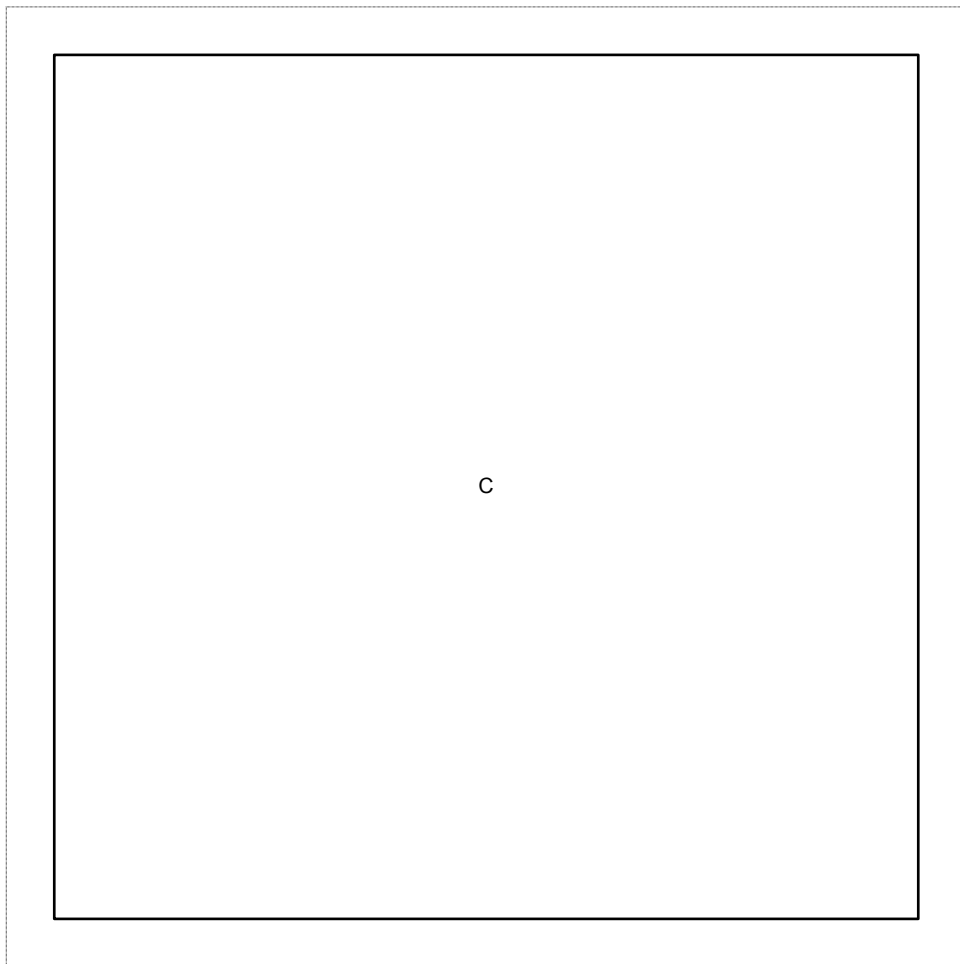
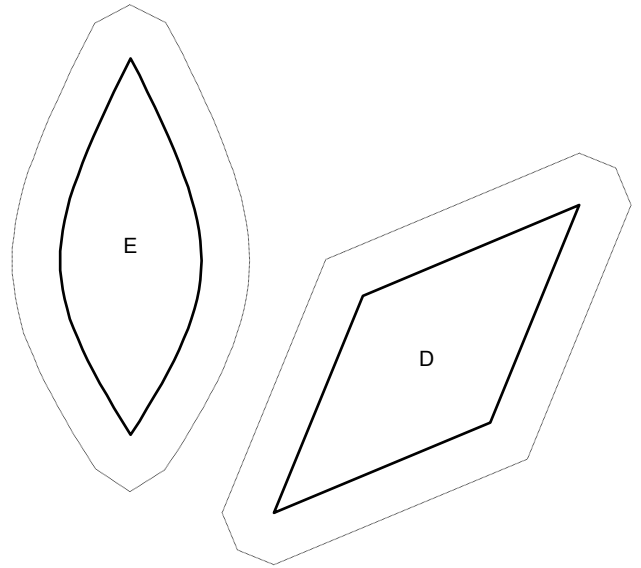
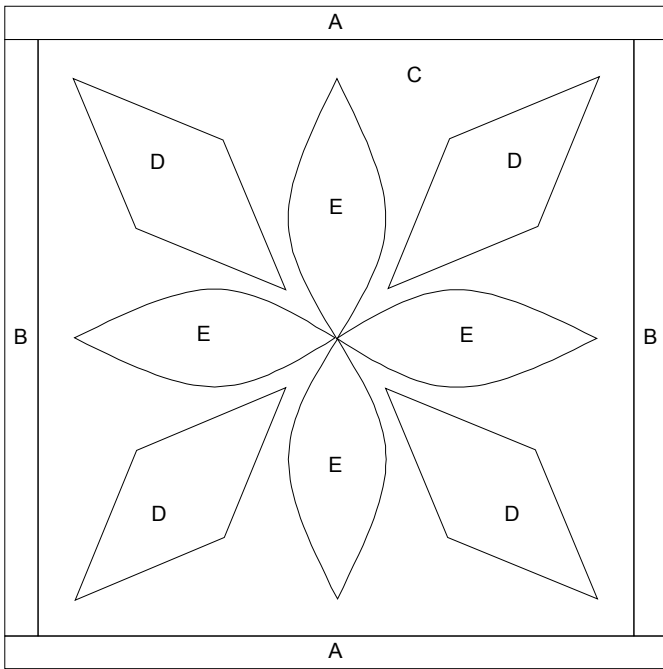

The Jane Stickle Quilt - Block D9

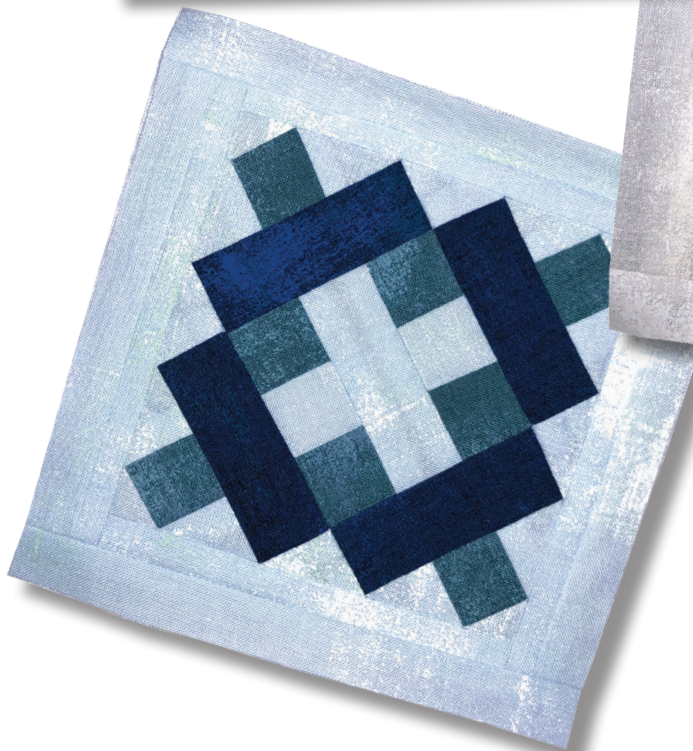

What you need:

| Patches | Quantity/size |
|---------|---|
| A* | (2) 1" x 6" |
| B* | (4) 1" x 5" |
| C | (2) 1" x 4¾" |
| D | (2) 1¾" x 1¾", cut once diagonally |
| E | (3) 2½" x 2½", cut twice diagonally |
| F | (8) 1½" x 1½" - green (2) 1½" x 1½" - light blue |
| G | (1) 1½" x 3" - light blue (4) 1½" x 3" - navy |

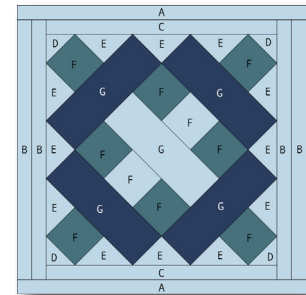

Hobbystash Colorway

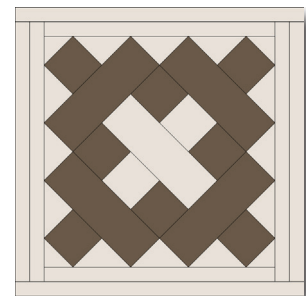

Jane Stickle Colorway

**The actual required width for Unit A and Unit B units is ¾". The increased width specified above allows for squaring the block to exactly 5½".*

Assembly:

1. Using the templates provided on Page D9-2, foundation piece each section.
2. Join the sections together.
3. Join Unit B to the right side of the block, and then the left.
4. Join Unit A to the top of the block and then the bottom. Square up block to measure 5½" x 5½"

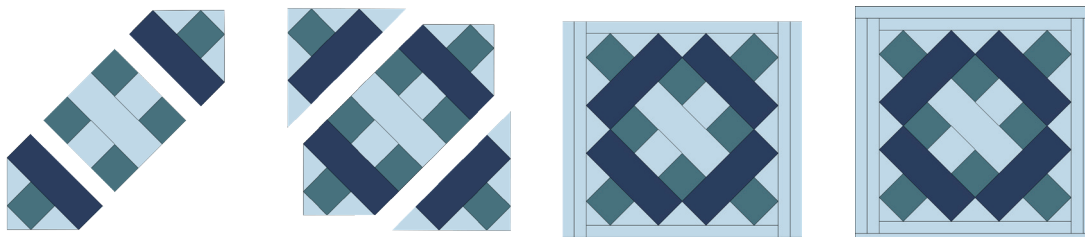

SET PRINTER TO "ACTUAL SIZE" WHEN PRINTING THIS PAGE.

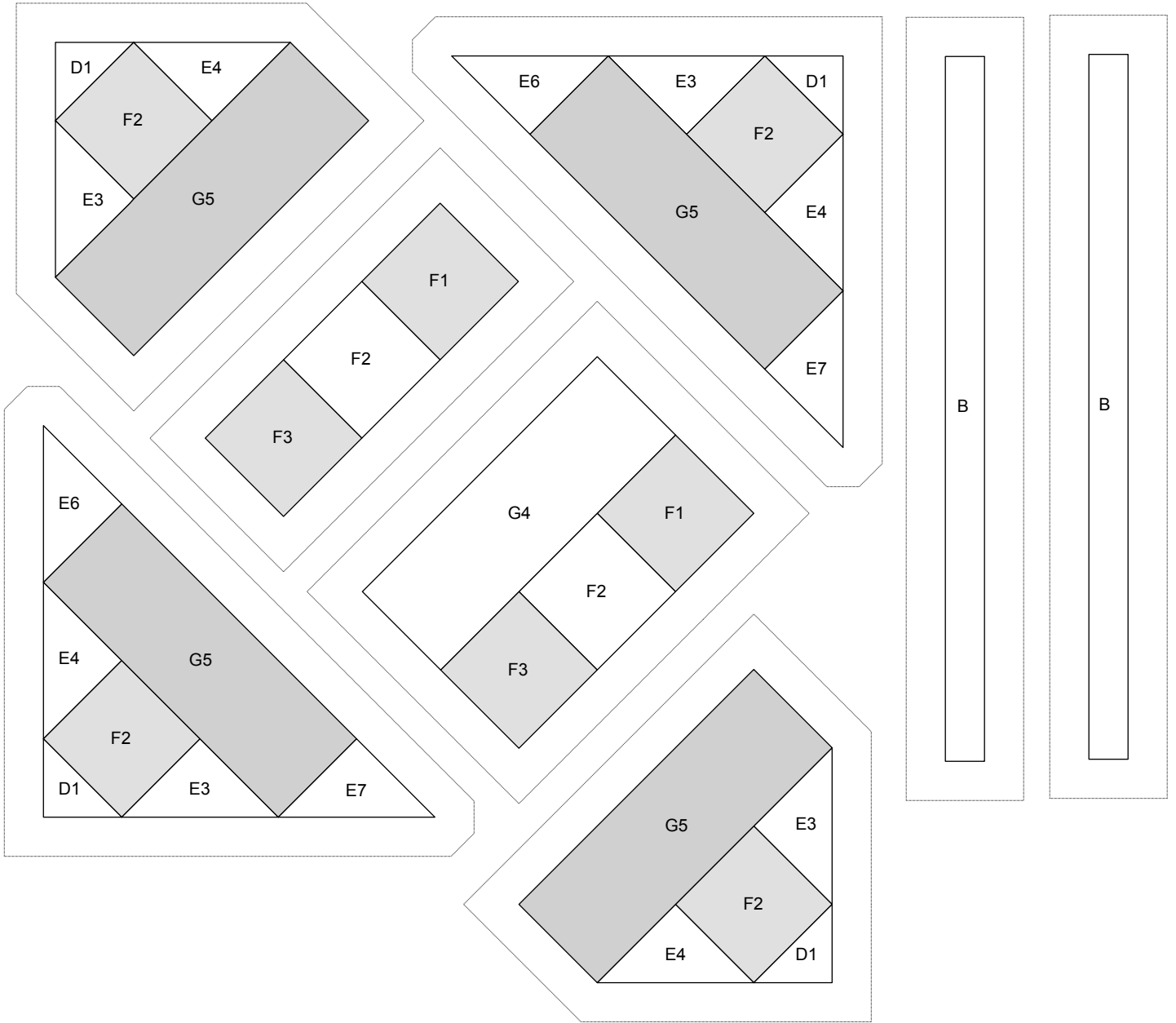

SET PRINTER TO "ACTUAL SIZE" WHEN PRINTING THIS PAGE.

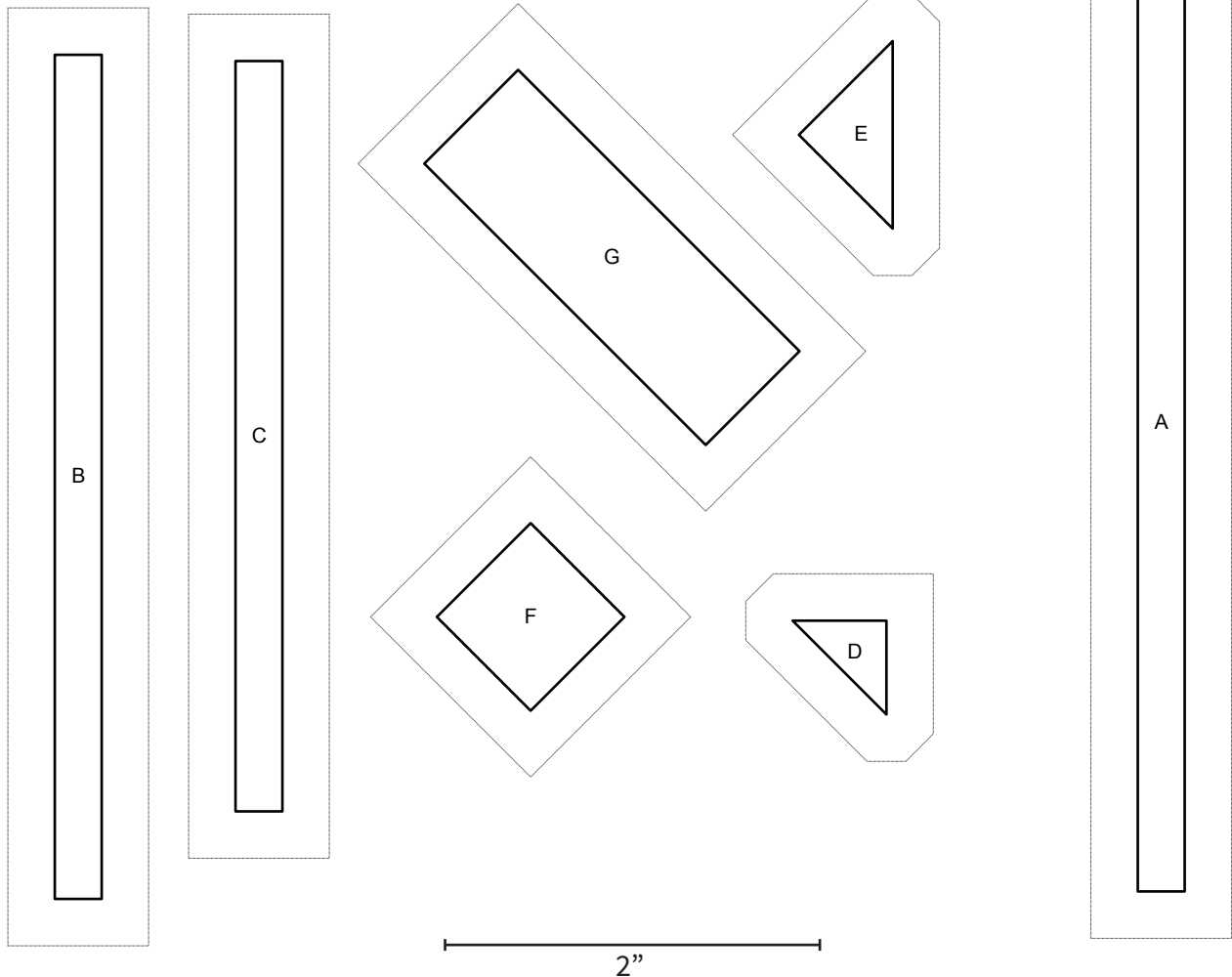
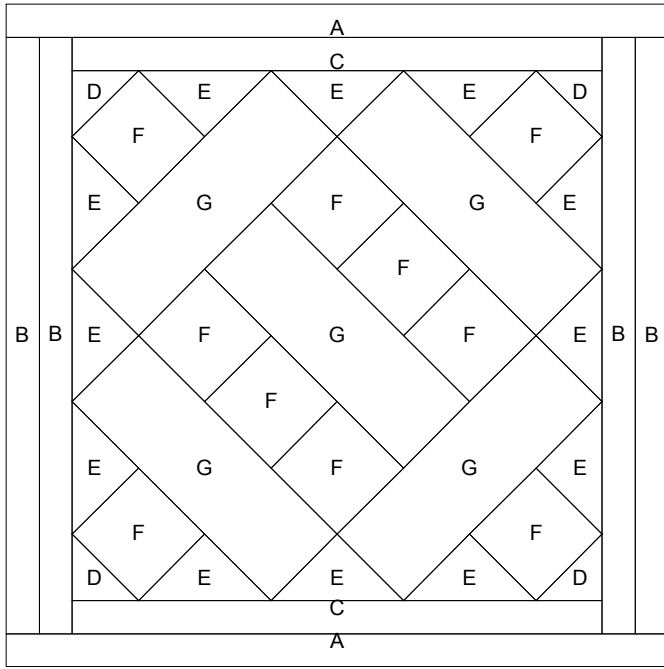

The Jane Stickle Quilt - Block D10

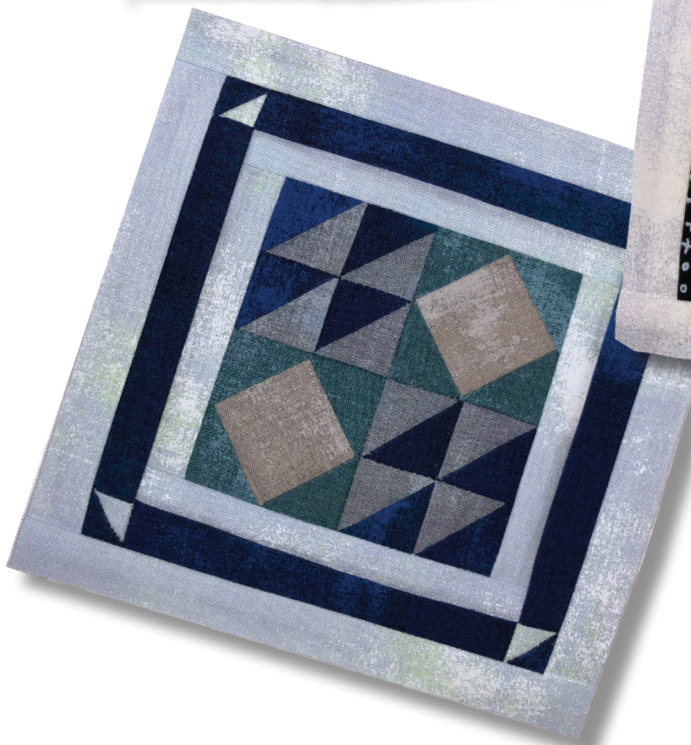

What you need:

| Patches | Quantity/size |
|---------|--|
| A* | (2) 1" x 6" |
| B* | (4) 1" x 5" |
| C | (2) 1½" x 1½", cut once diagonally - navy (2) 1½" x 1½", cut once diagonally - light blue |
| D | (2) 1¼" x 4½" - light blue (4) 1¼" x 4½" - navy |
| E | (2) 1¼" x 4" |
| F | (4) 2" x 2" - navy, cut once diagonally (4) 2" x 2" - gray, cut once diagonally (4) 2" x 2" - green, cut once diagonally |
| G | (2) 1¾" x 1¾" |

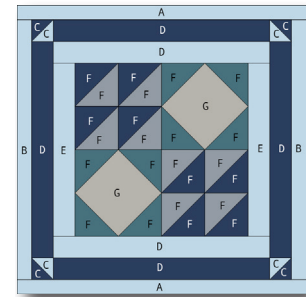

Hobbystash Colorway

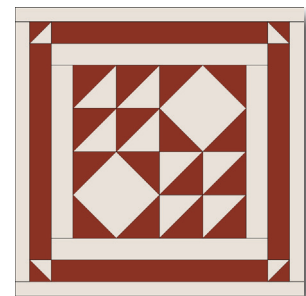

Jane Stickle Colorway

**The actual required width for Unit A and Unit B units is ¾". The increased width specified above allows for squaring the block to exactly 5½".*

Assembly:

- Using the templates provided on Page D10-2, foundation piece each section.
- Join the sections together.
- Join Unit B to the right side of the block, and then the left.
- Join Unit A to the top of the block and then the bottom. Square up block to measure 5½" x 5½"

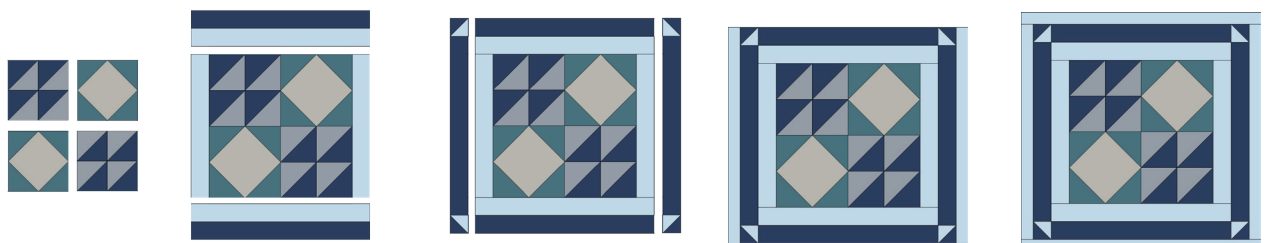

SET PRINTER TO "ACTUAL SIZE" WHEN PRINTING THIS PAGE.

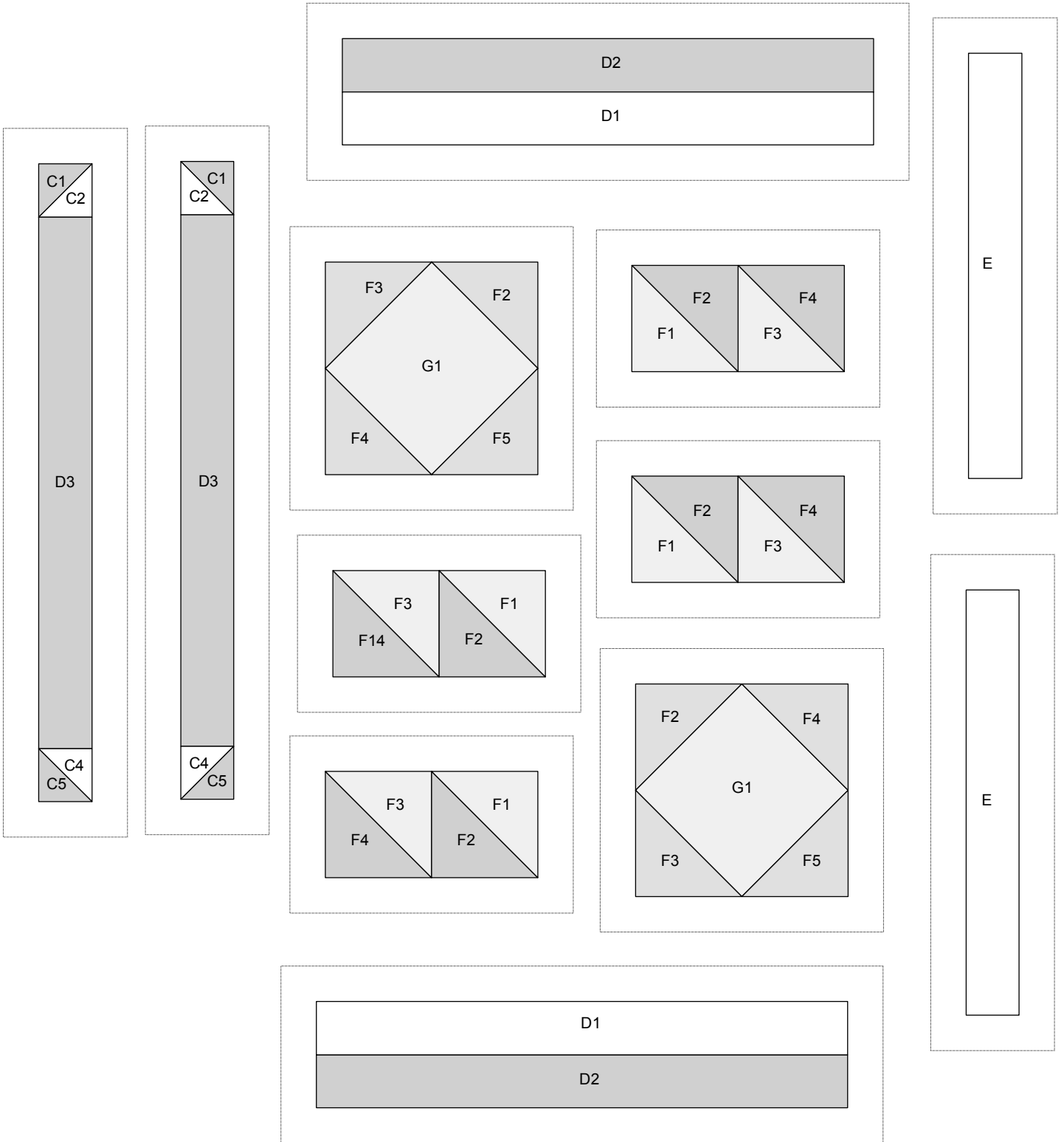

2"

SET PRINTER TO "ACTUAL SIZE" WHEN PRINTING THIS PAGE.

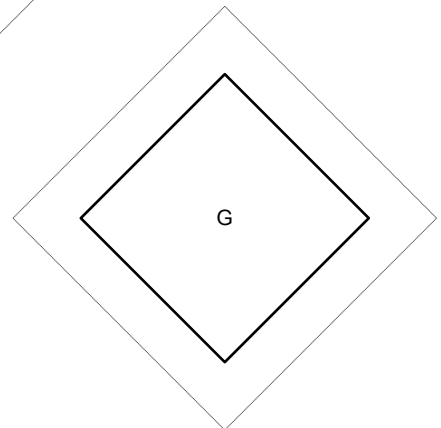
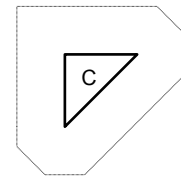
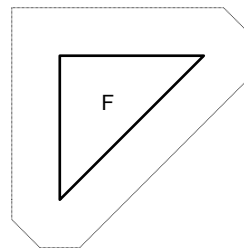
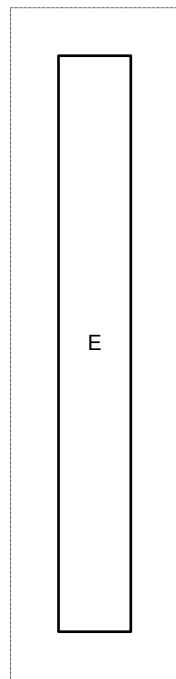
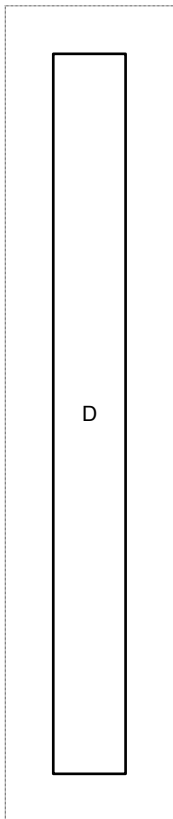
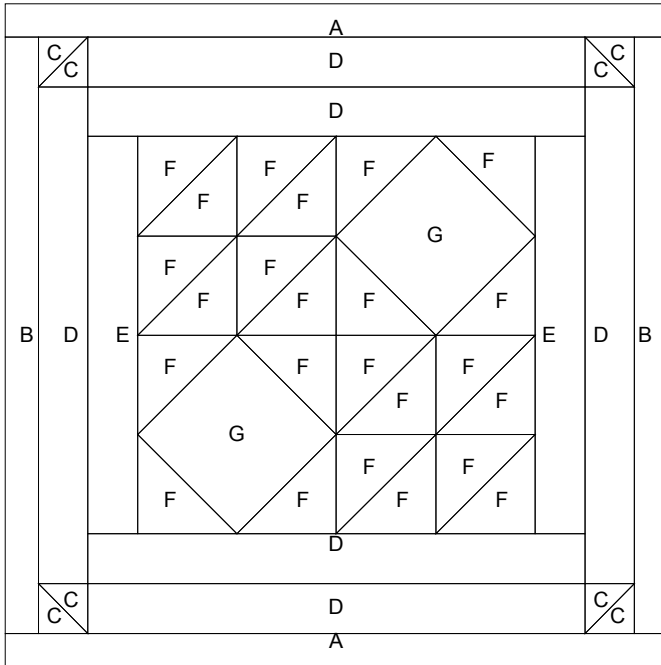

2"

The Jane Stickle Quilt - Block D11

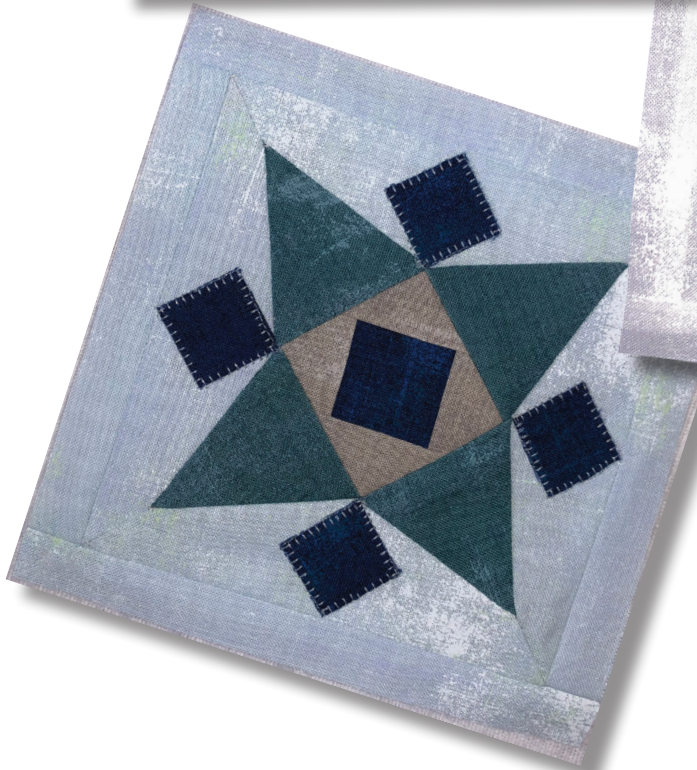
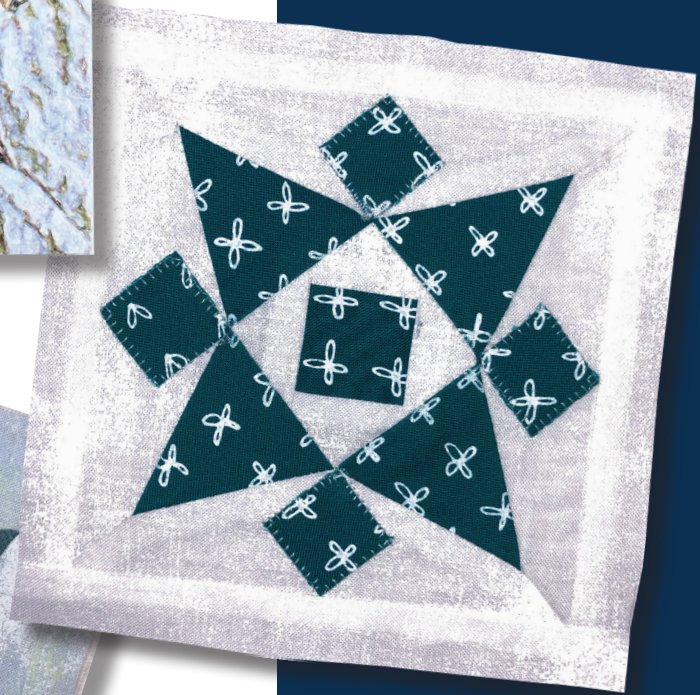

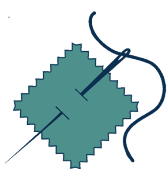

What you need:

| Patches | Quantity/size |
|---------|-----------------------------------|
| A* | (2) 1" x 6" |
| B* | (2) 1" x 5" |
| C | (4) 2" x 5¼" |
| D | (4) 3" x 3" |
| E/F | (1) 3" x 3", cut twice diagonally |
| G | (1) 1¾" x 1¾" |
| H | (4) 1¾" x 1¾" |

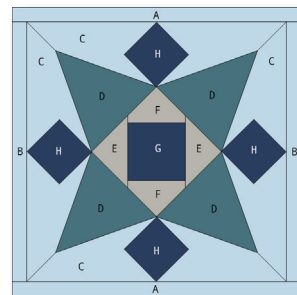

Hobbystash Colorway

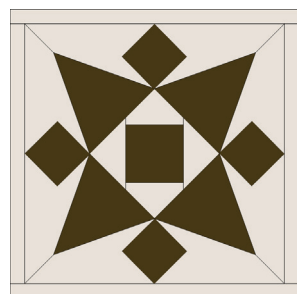

Jane Stickle Colorway

**The actual required width for Unit A and Unit B units is ¾". The increased width specified above allows for squaring the block to exactly 5½".*

Assembly:

1. Using the templates provided on Page D11-2, foundation piece each section.
2. Join the sections together.
3. Appliqué the four Unit H square pieces to the block.
4. Join Unit B to the right side of the block, and then the left.
5. Join Unit A to the top of the block and then the bottom. Square up block to measure 5½" x 5½"

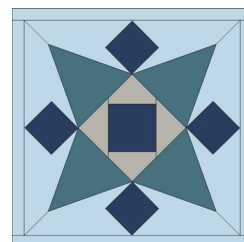
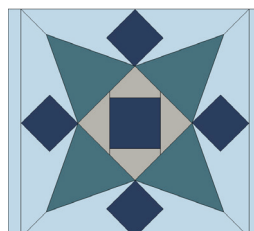
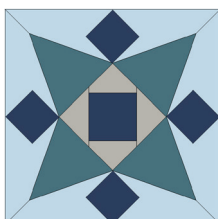
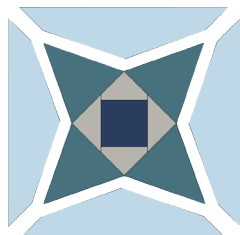
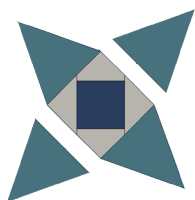

SET PRINTER TO "ACTUAL SIZE" WHEN PRINTING THIS PAGE.

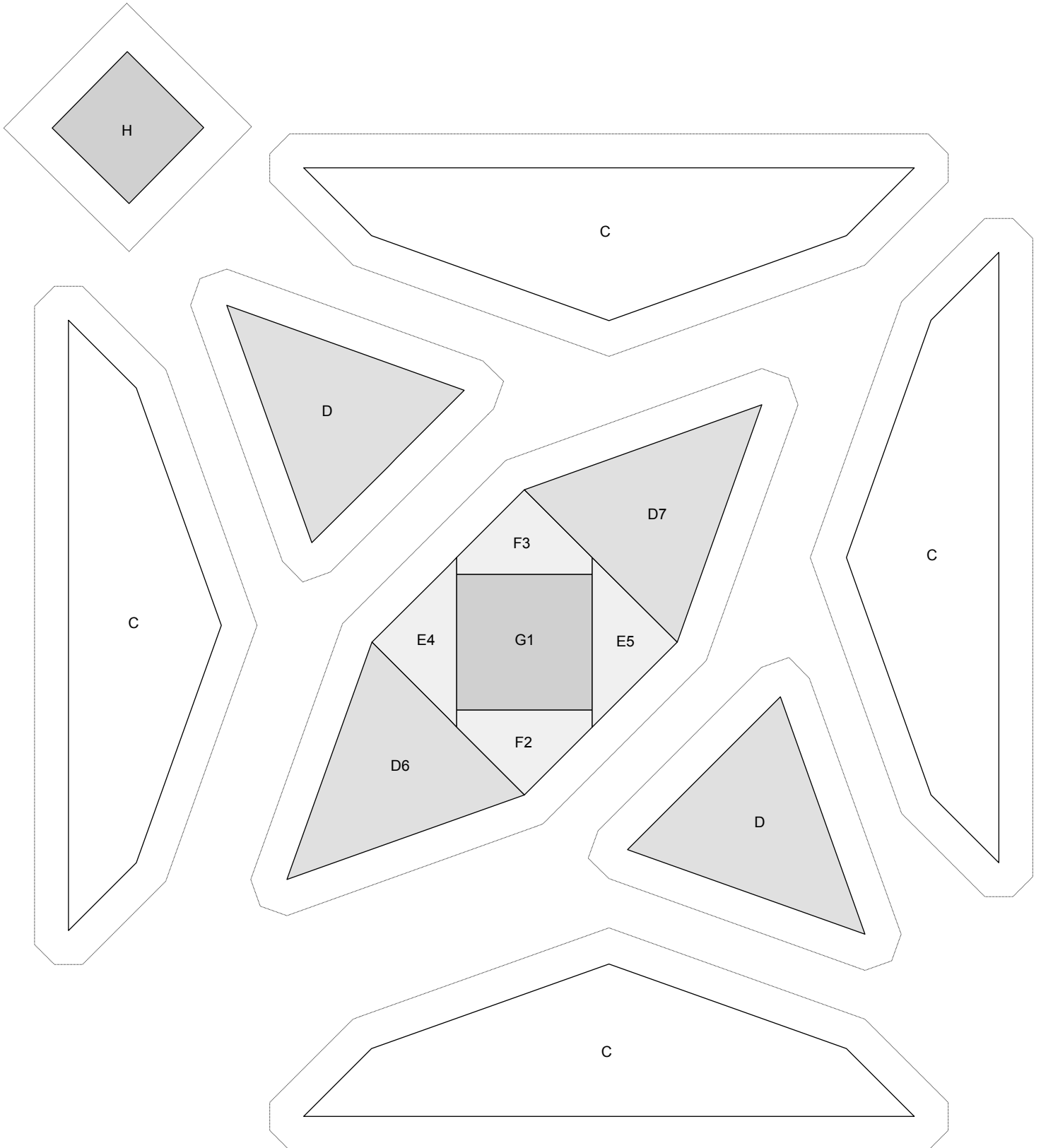

2"

SET PRINTER TO "ACTUAL SIZE" WHEN PRINTING THIS PAGE.

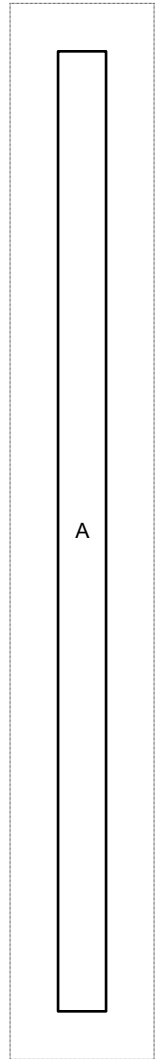
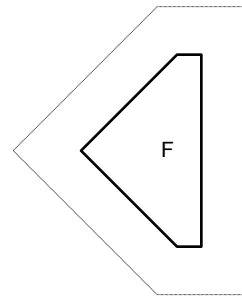
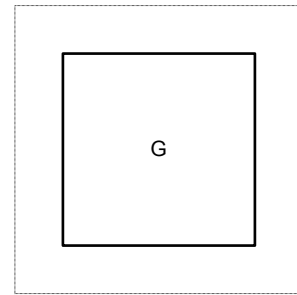
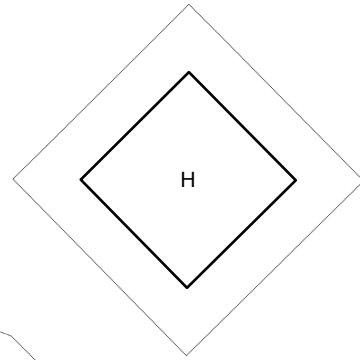
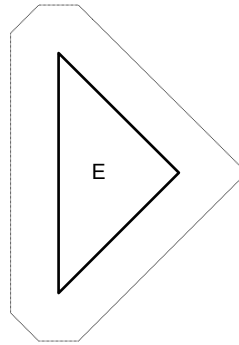
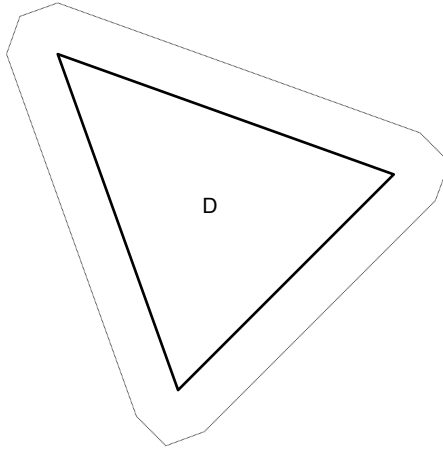
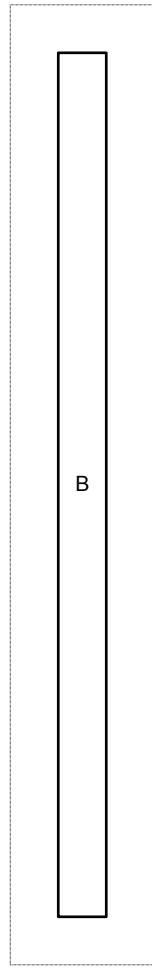
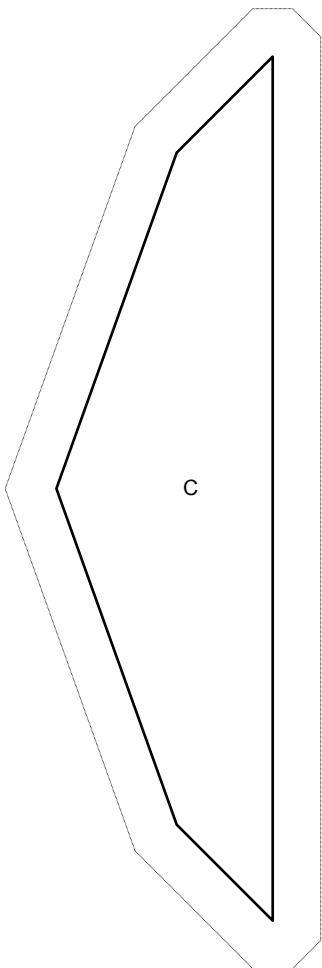
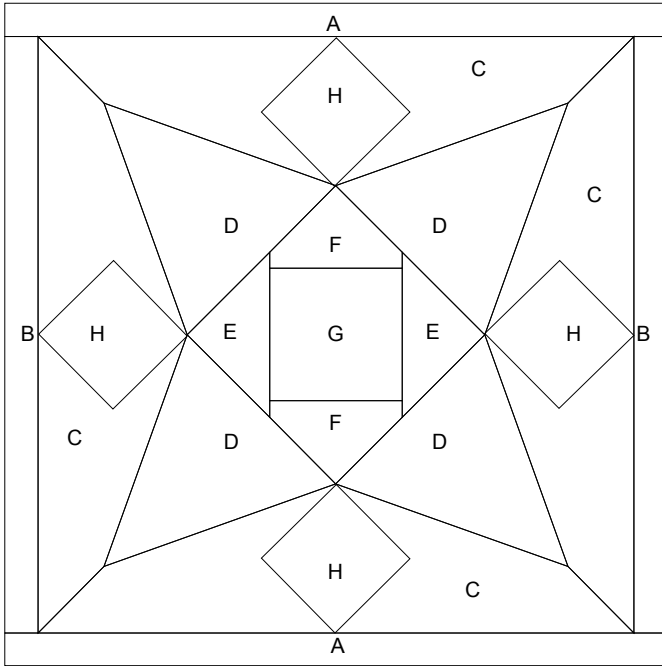

2"

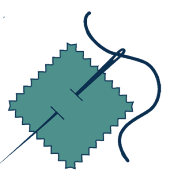

SET PRINTER TO "ACTUAL SIZE" WHEN PRINTING THIS PAGE.
(This template eliminates applique and inset seams)

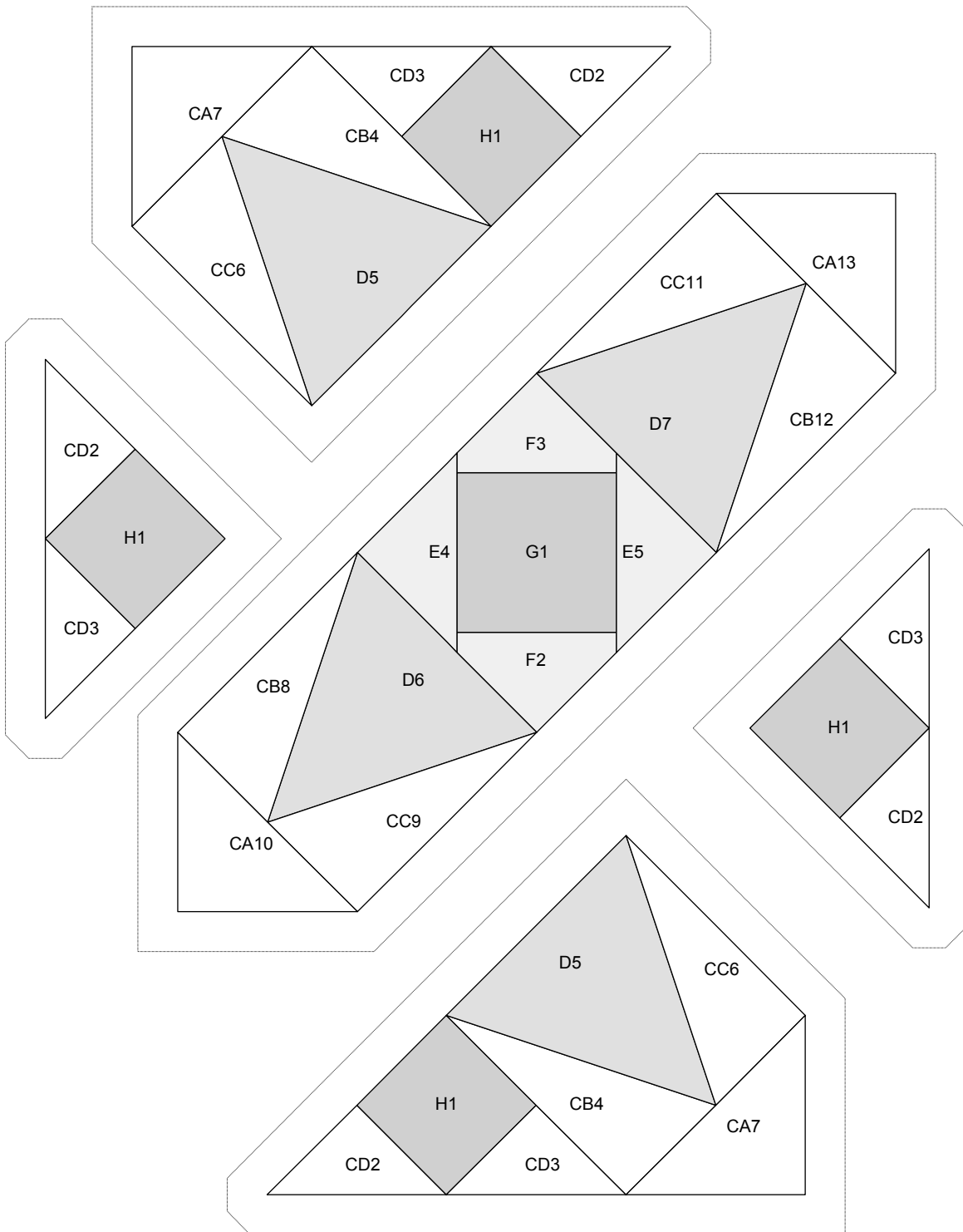

2"

The Jane Stickle Quilt - Block D12



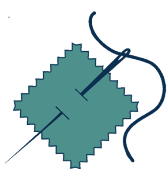

What you need:

| Patches | Quantity/size |
|---------|------------------------------------|
| A* | (2) 1" x 6" |
| B* | (2) 1" x 5" |
| C | (4) 1½" x 1½" |
| D | (2) 2½" x 3½", cut once diagonally |
| E | (2) 1½" x 3" |
| F | (2) 2½" x 3½", cut once diagonally |
| G | (4) 1½" x 5¼" |
| H | (4) 2" x 3" |

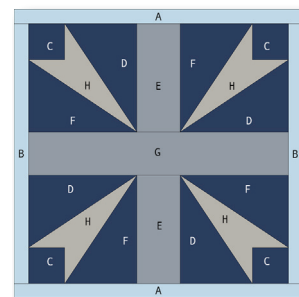

Hobbystash Colorway

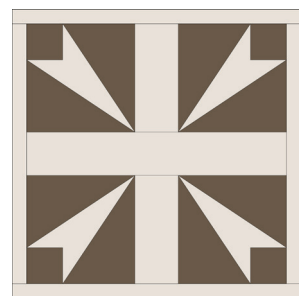

Jane Stickle Colorway

**The actual required width for Unit A and Unit B units is ¾". The increased width specified above allows for squaring the block to exactly 5½".*

Assembly:

1. Using the templates provided on Page D12-2, foundation piece each section.
2. Join the sections together.
3. Join Unit B to the right side of the block, and then the left.
4. Join Unit A to the top of the block and then the bottom. Square up block to measure 5½" x 5½"

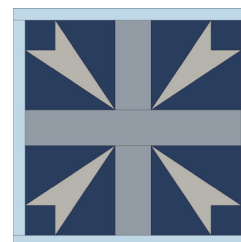
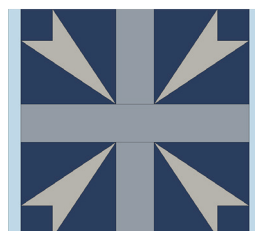

SET PRINTER TO "ACTUAL SIZE" WHEN PRINTING THIS PAGE.

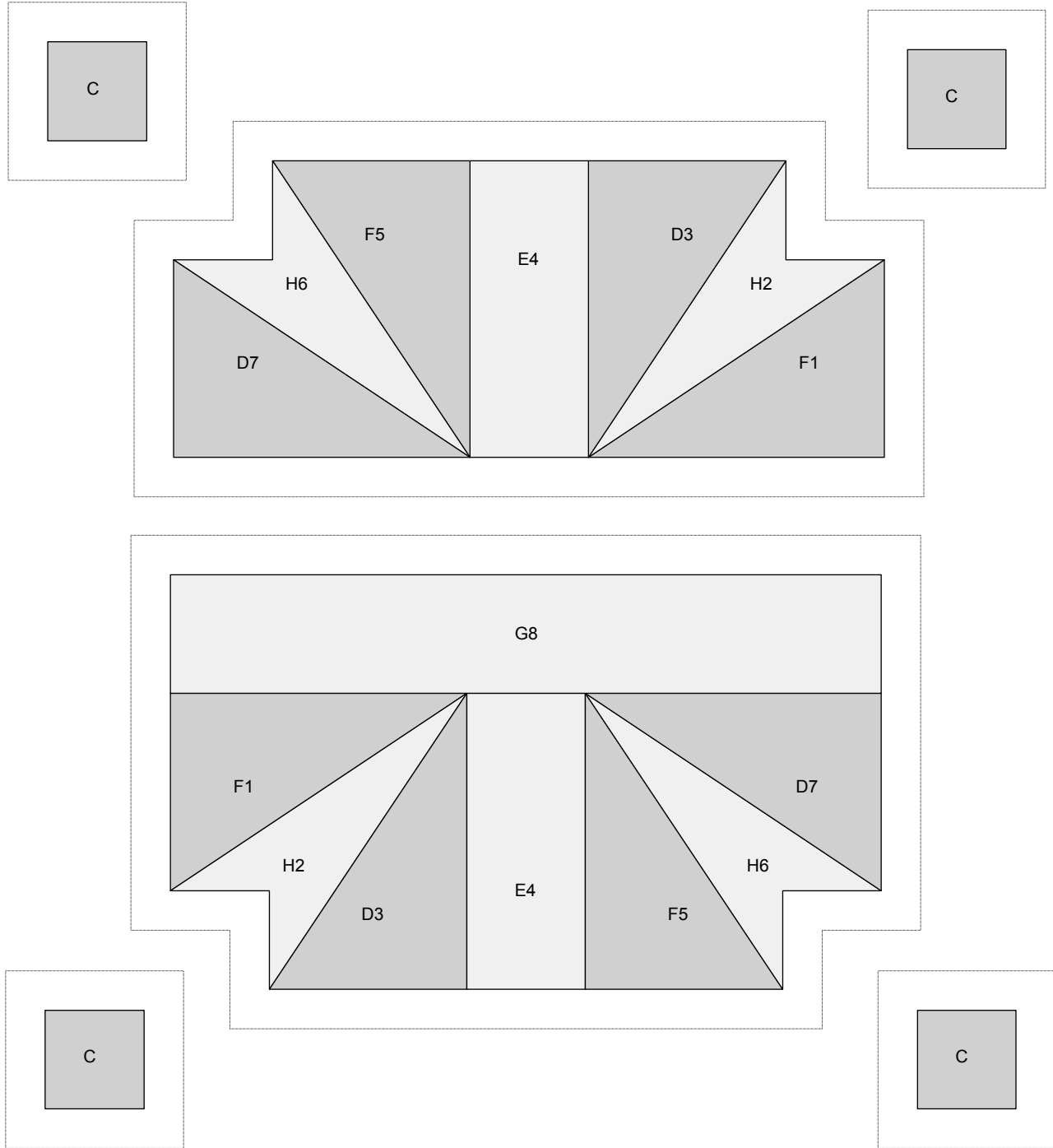

2"

SET PRINTER TO "ACTUAL SIZE" WHEN PRINTING THIS PAGE.

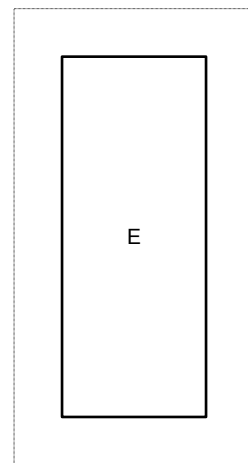
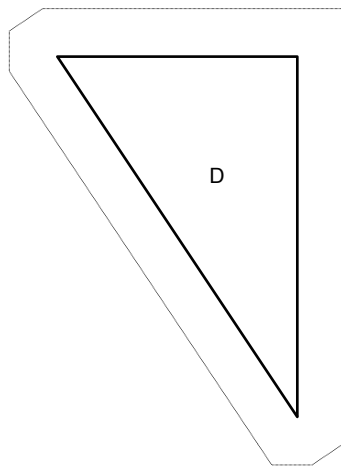
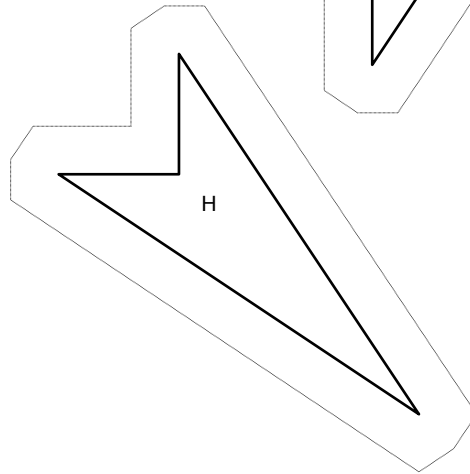
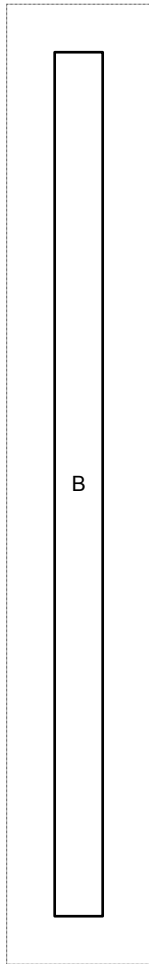
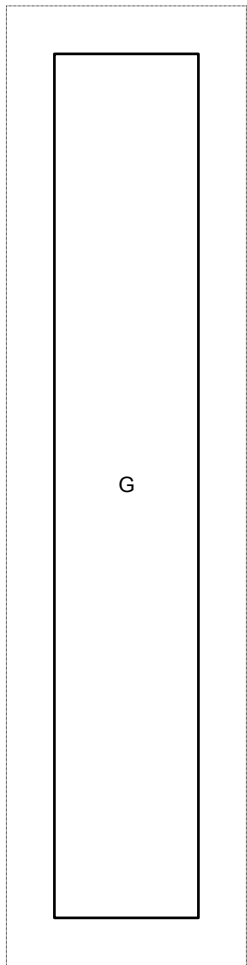
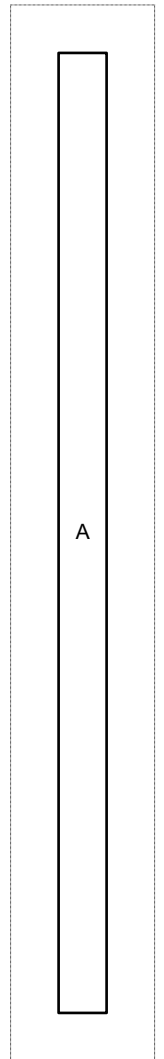
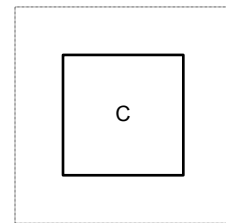
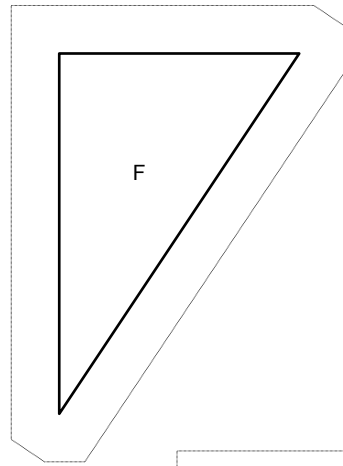
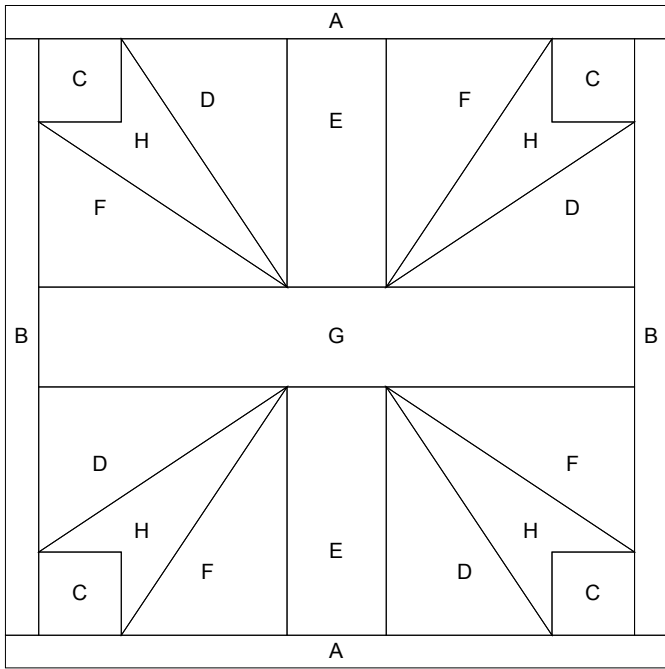

2"

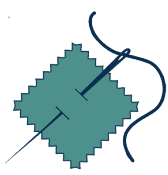

SET PRINTER TO "ACTUAL SIZE" WHEN PRINTING THIS PAGE.
(This template eliminates inset seams)

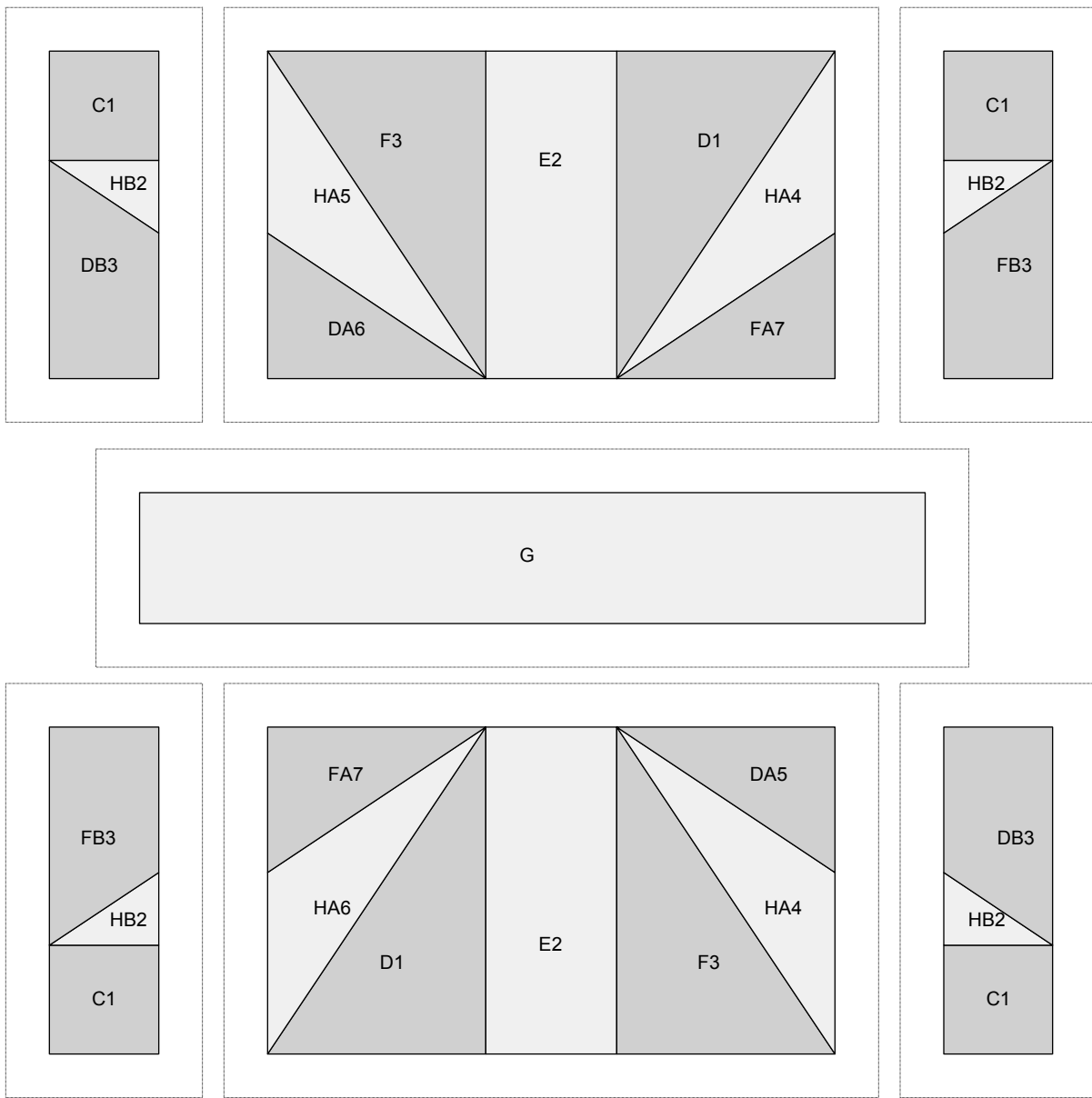

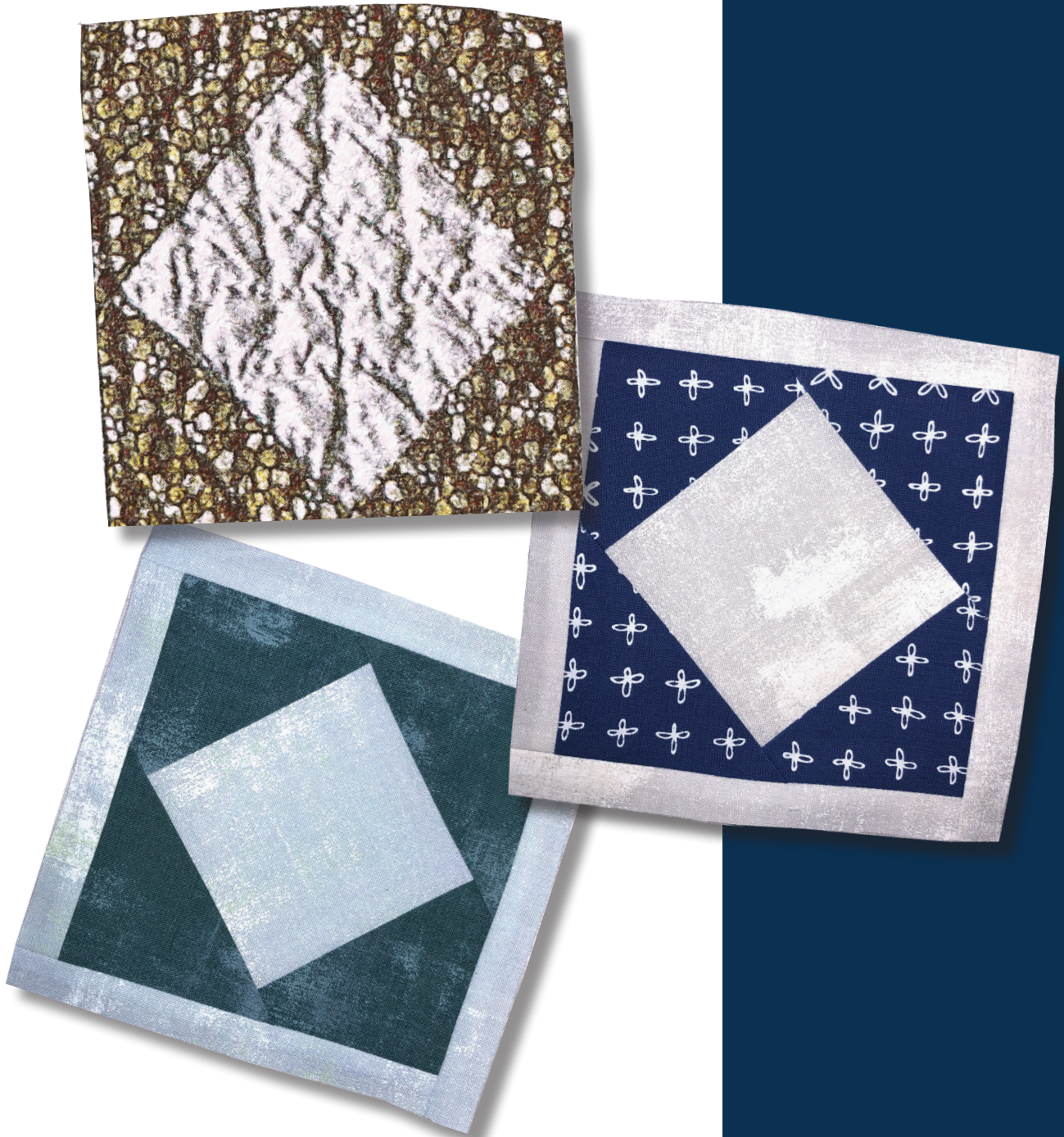

2"

The Jane Stickle Quilt - Block D13

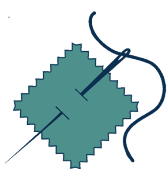



What you need:

| Patches | Quantity/size |
|---|----------------------------------|
| A* | (2) 1" x 6" |
| B* | (2) 1" x 5" |
| C  | (1) 4" x 4", cut once diagonally |
| D  | (1) 4" x 4", cut once diagonally |
| E | (1) 4" x 4" |

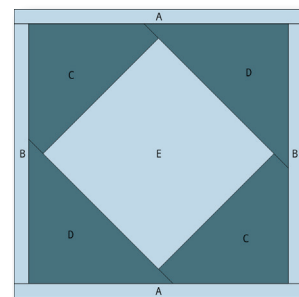

Hobbystash Colorway

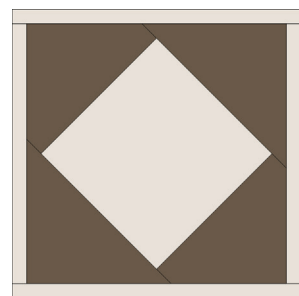

Jane Stickle Colorway

**The actual required width for Unit A and Unit B units is ¾". The increased width specified above allows for squaring the block to exactly 5½".*

Assembly:

1. Using the templates provided on Page D13-2, foundation piece the section.
2. Join Unit B to the right side of the block, and then the left.
3. Join Unit A to the top of the block and then the bottom. Square up block to measure 5½" x 5½"

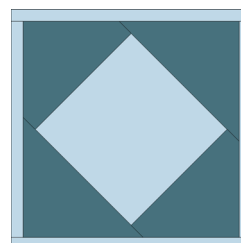
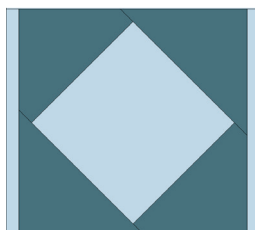
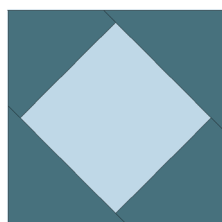

SET PRINTER TO "ACTUAL SIZE" WHEN PRINTING THIS PAGE.

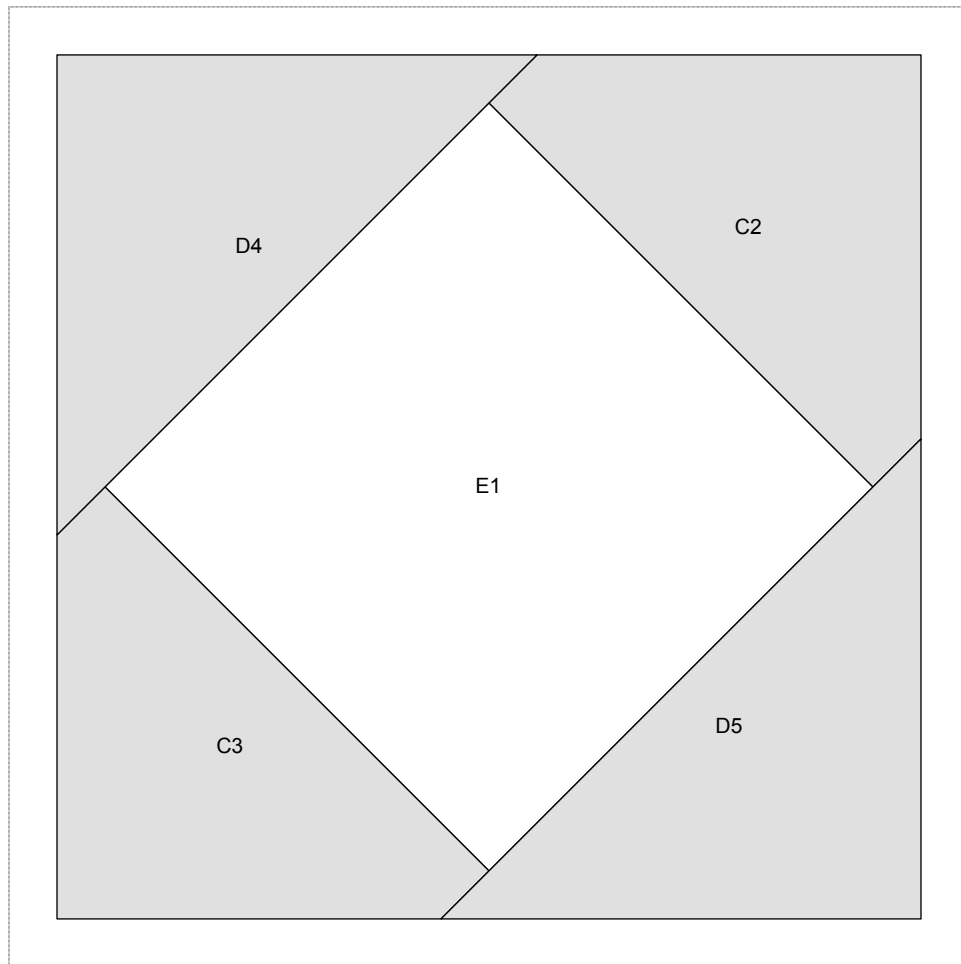

2"

SET PRINTER TO "ACTUAL SIZE" WHEN PRINTING THIS PAGE.

