

The Jane Stickle Quilt - Row C

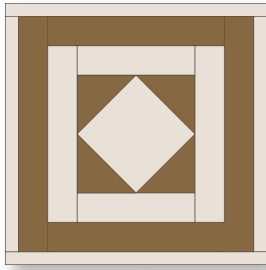

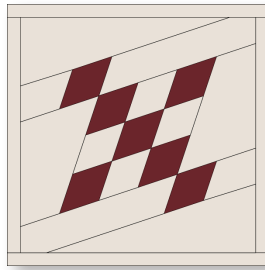

C1



C2

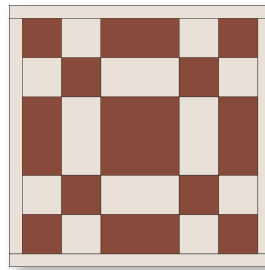

C3

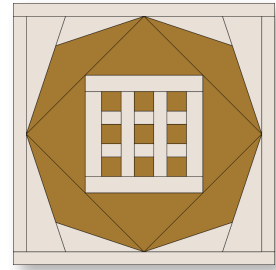

C4

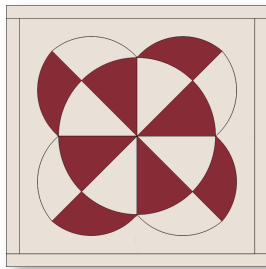

C5

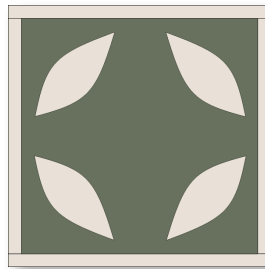

C6

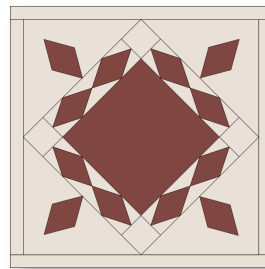

C7

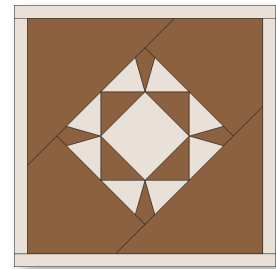

C8

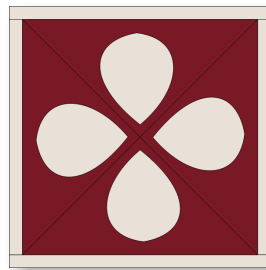

C9

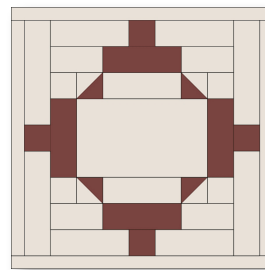

C10

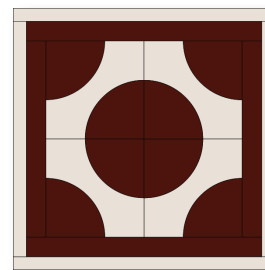

C11

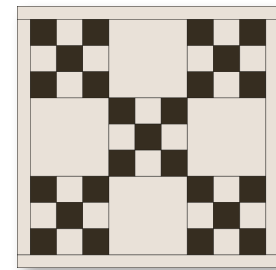

C12

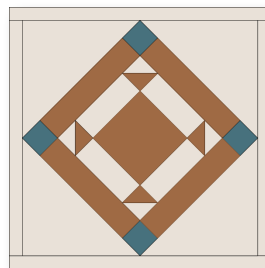

C13

The Jane Stickle Quilt - Block C1



What you need:

Units	Quantity/size
A*	(2) 1" x 6"
B*	(2) 1" x 5"
C	(2) 1½" x 5½"
D	(2) 1½" x 4½" - green (2) 1½" x 4½" - beige
E	(2) 1½" x 3½"
F	(2) 2½" x 2½", cut once diagonally
G	(1) 2½" x 2½"

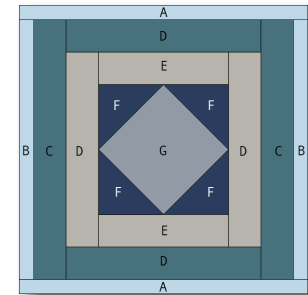

Hobbystash Colorway

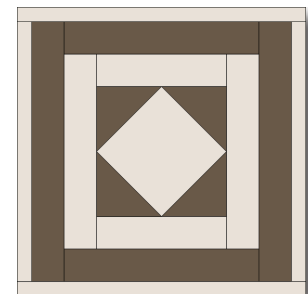

Jane Stickle Colorway

**The actual required width for Unit A and Unit B units is ¾". The increased specified width allows for squaring the block to exactly 5½".*

Assembly:

1. Using the templates provided on Page C1-2, foundation piece the single section.
2. Join Unit B to the right side of the block, and then the left.
3. Join Unit A to the top of the block and then the bottom. Square up block to measure 5½" x 5½"

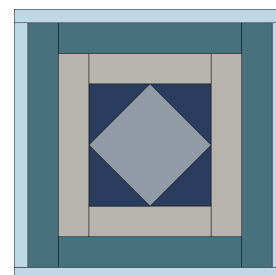
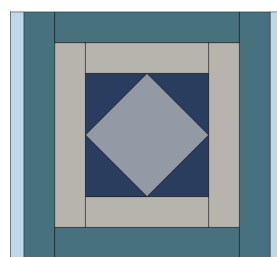
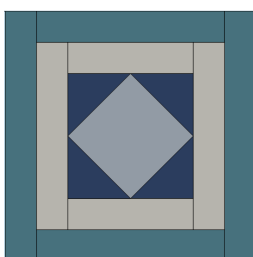

SET PRINTER TO "ACTUAL SIZE" WHEN PRINTING THIS PAGE.

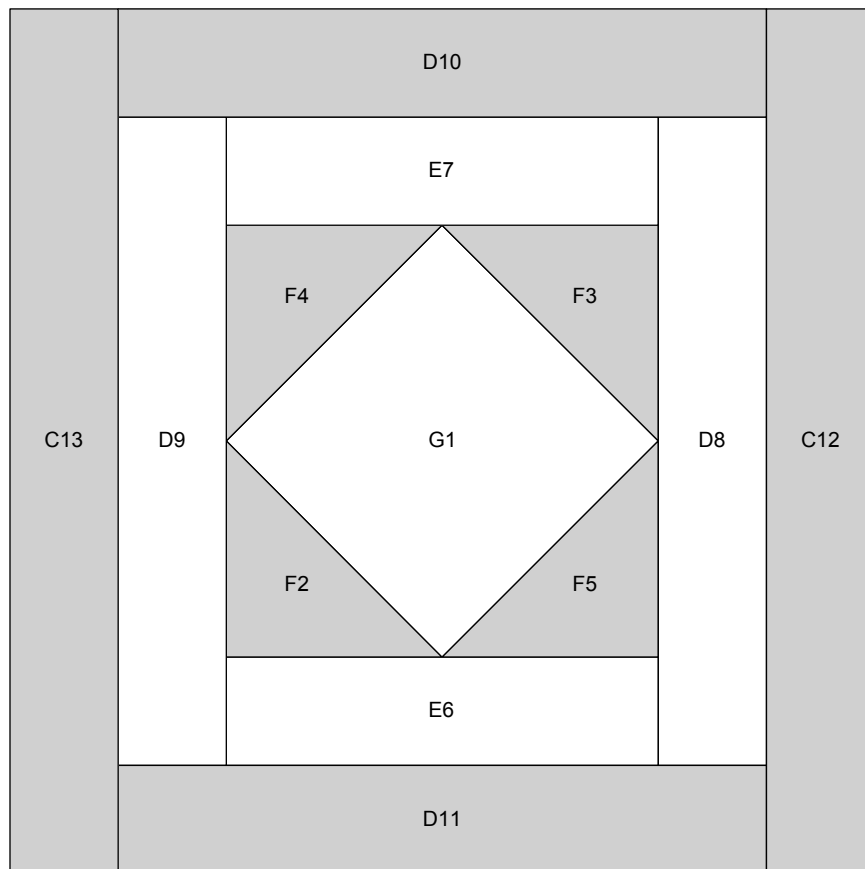

2"

SET PRINTER TO "ACTUAL SIZE" WHEN PRINTING THIS PAGE.

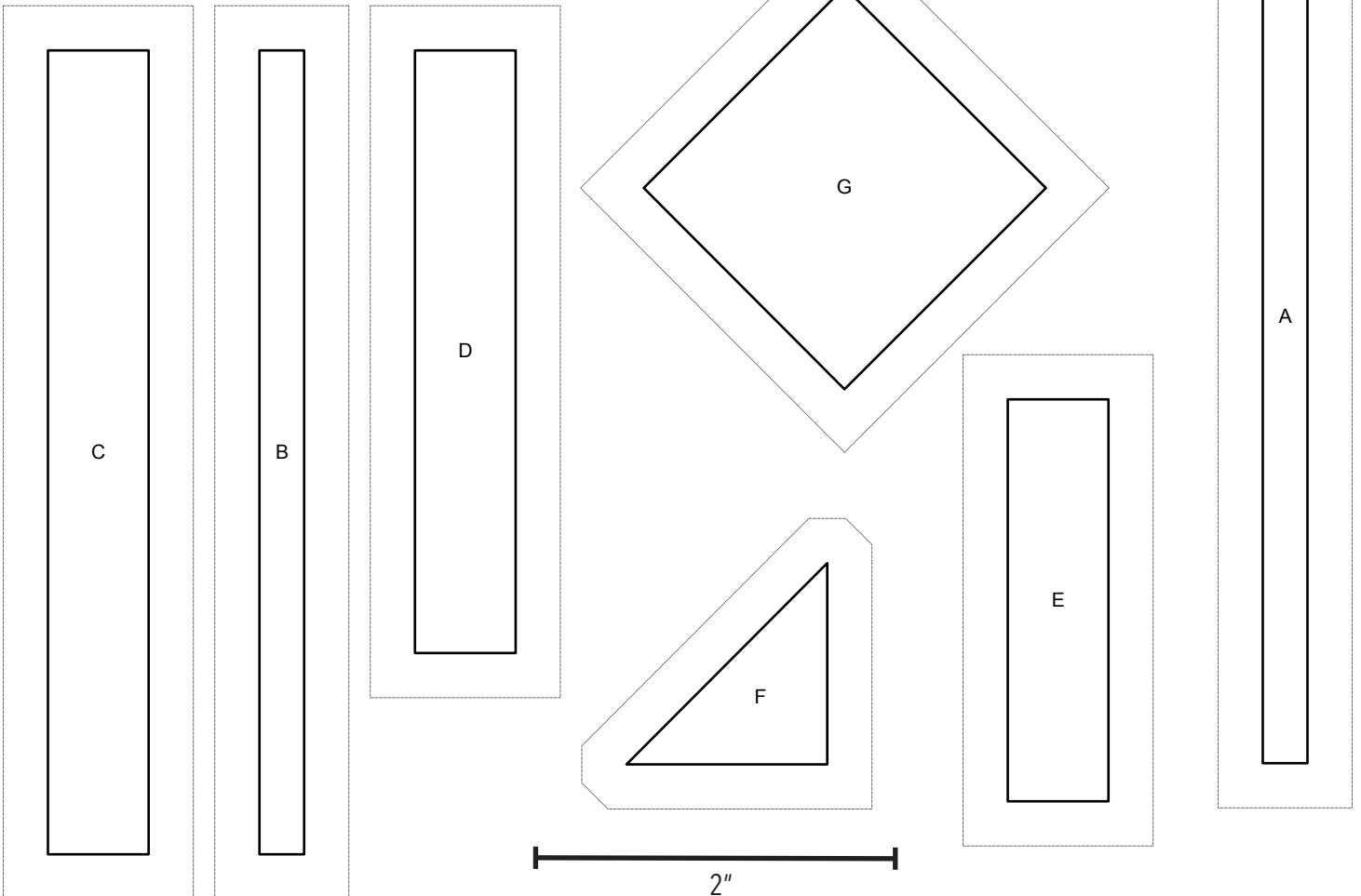
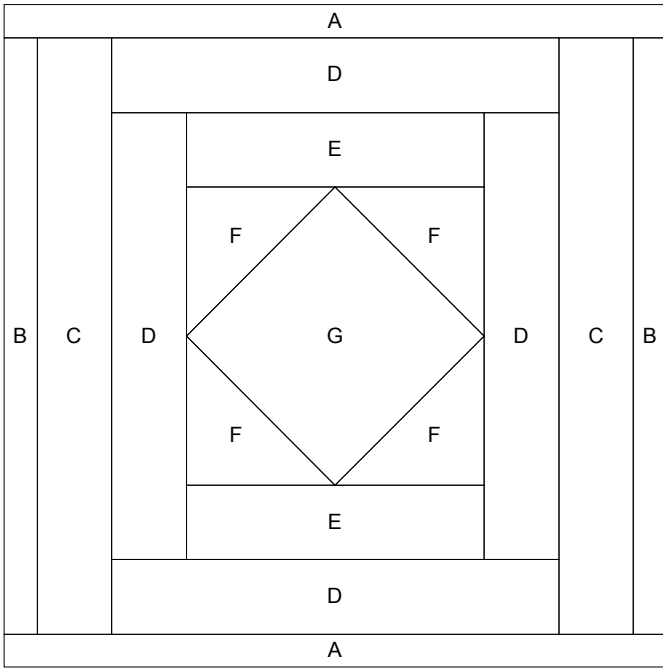

The Jane Stickle Quilt - Block C2

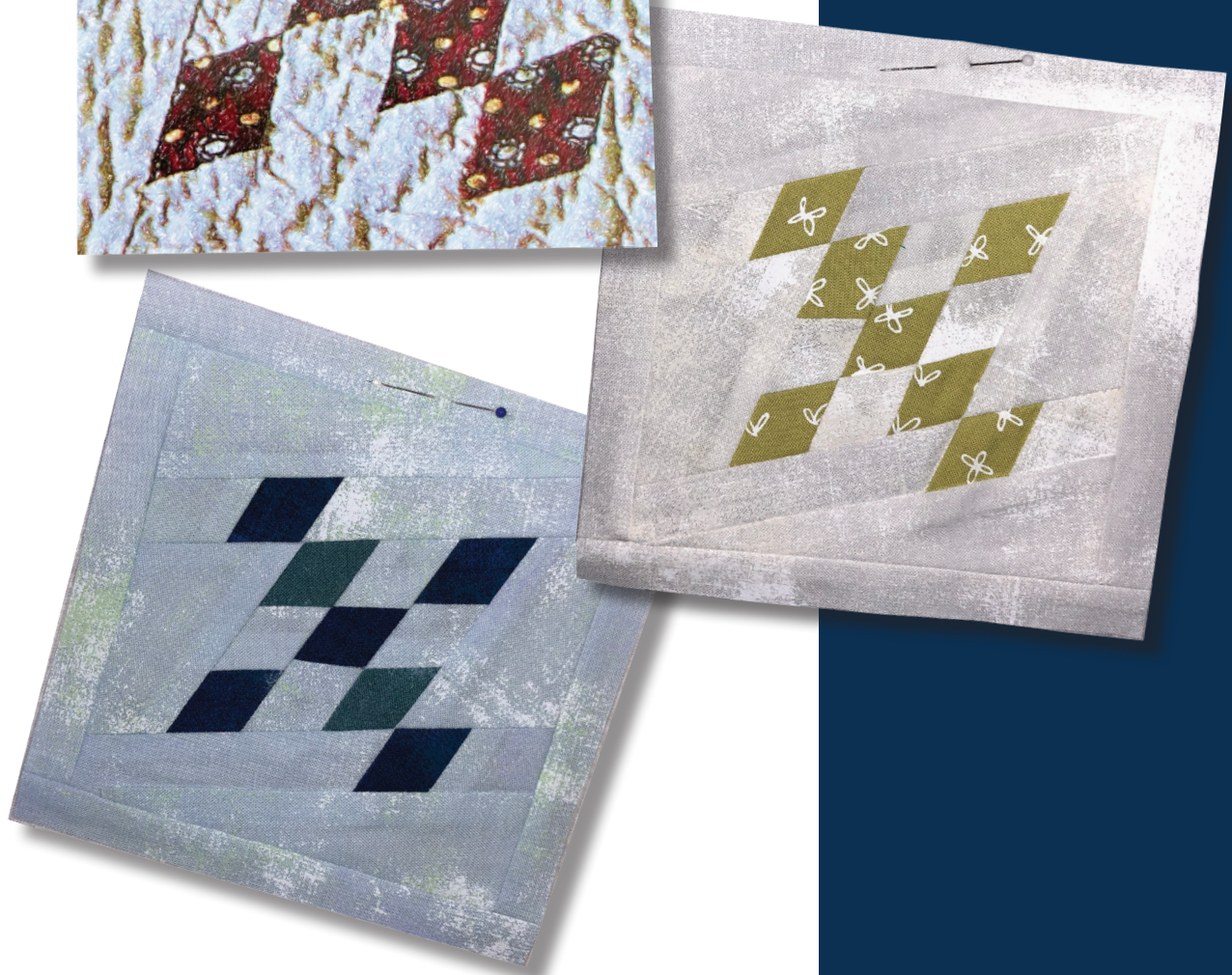
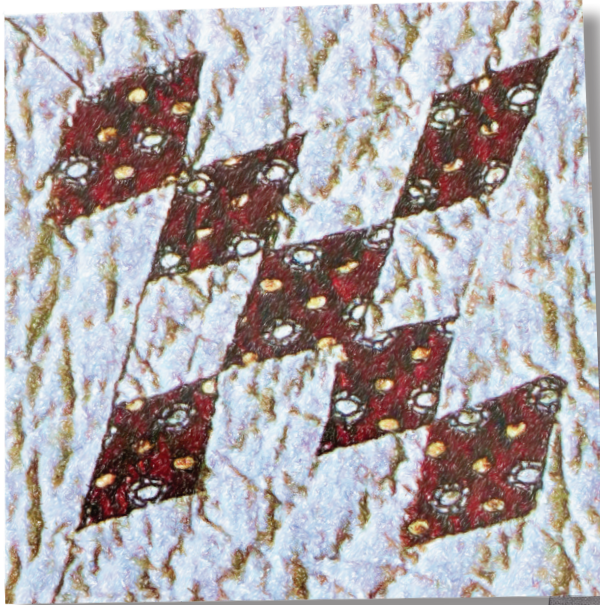

What you need:

Units	Quantity/size
A*	(2) 1" x 6"
B*	(2) 1" x 5"
C	(2) 2" x 6"
D	(2) 2" x 4"
E	(2) 2" x 4"
F	(2) 2" x 2"
G	(4) 2" x 2" - light blue (5) 2" x 2" - navy (2) 2" x 2" - green

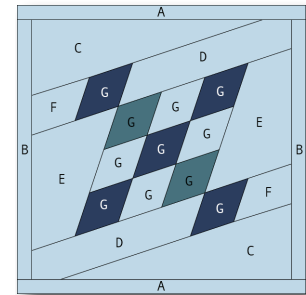

Hobbystash Colorway

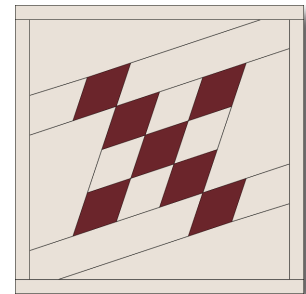

Jane Stickle Colorway

**The actual required width for Unit A and Unit B units is ¾". The increased specified width allows for squaring the block to exactly 5½".*

Assembly:

- Using the templates provided on Page C2-2, foundation piece each section.
- Join the sections together.
- Join Unit B to the right side of the block, and then the left.
- Join Unit A to the top of the block and then the bottom. Square up block to measure 5½" x 5½"

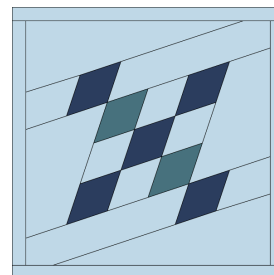
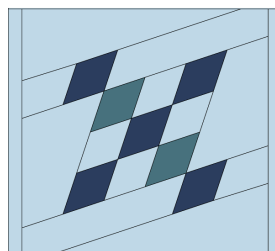
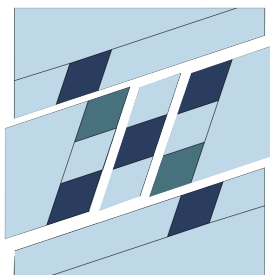

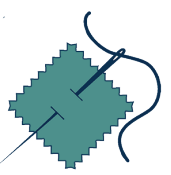

SET PRINTER TO "ACTUAL SIZE" WHEN PRINTING THIS PAGE.

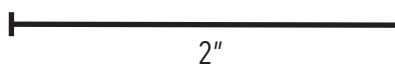
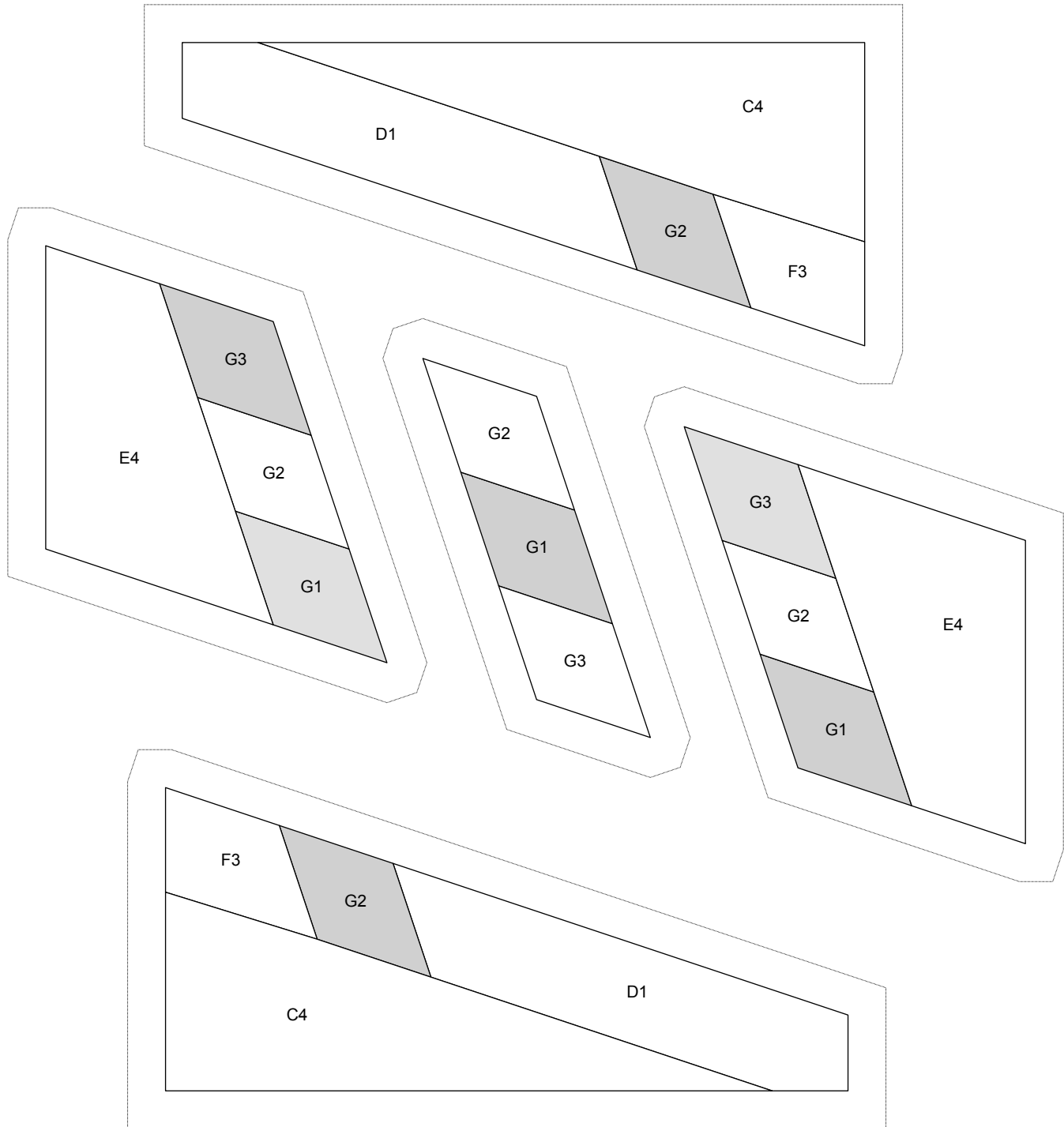

SET PRINTER TO "ACTUAL SIZE" WHEN PRINTING THIS PAGE.

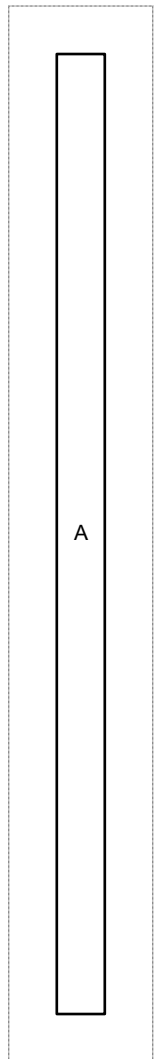
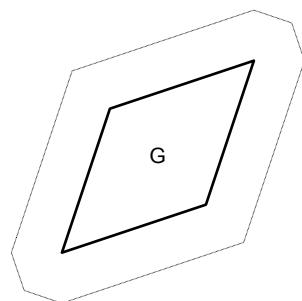
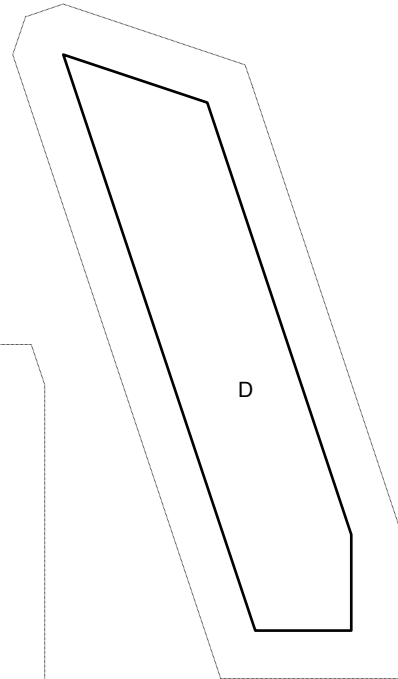
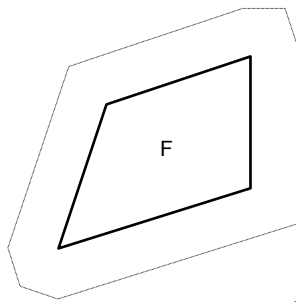
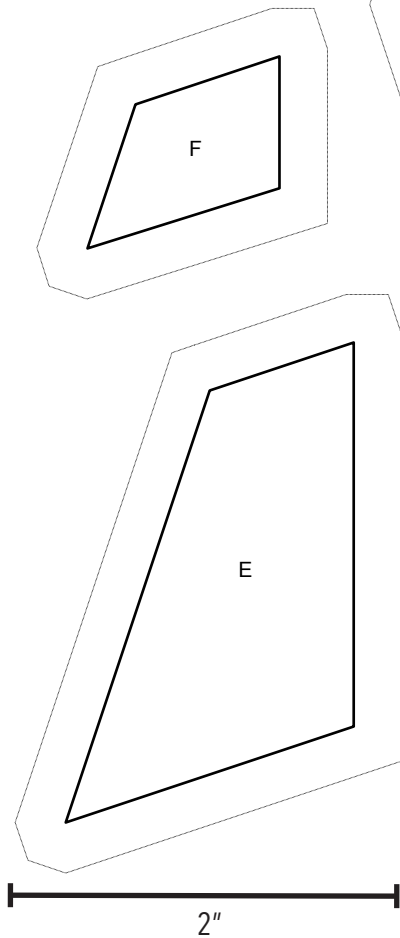
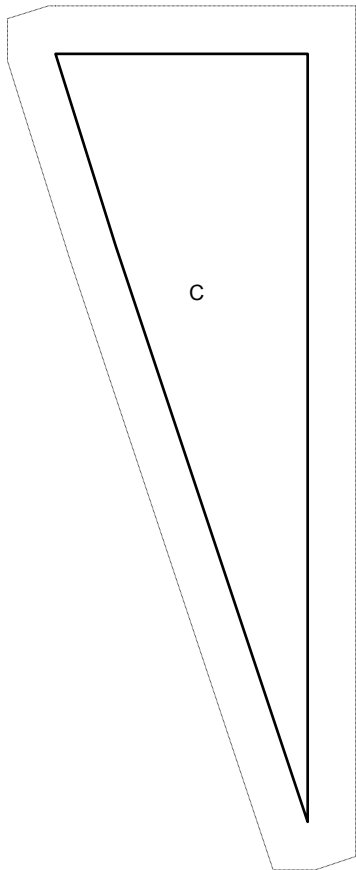
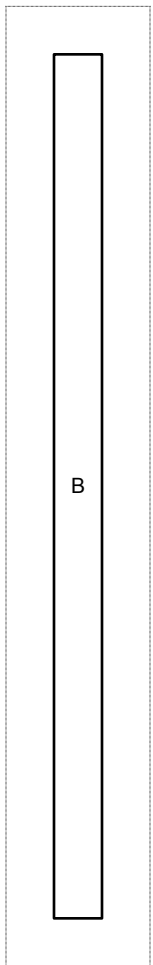
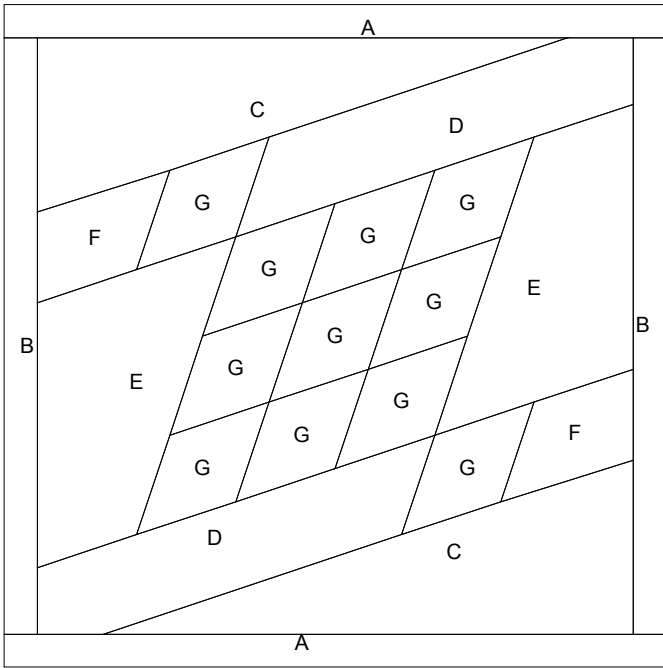

SET PRINTER TO "ACTUAL SIZE" WHEN PRINTING THIS PAGE.

This version more closely resembles the original block, which includes inset seams and appliqué.

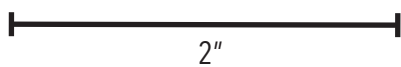
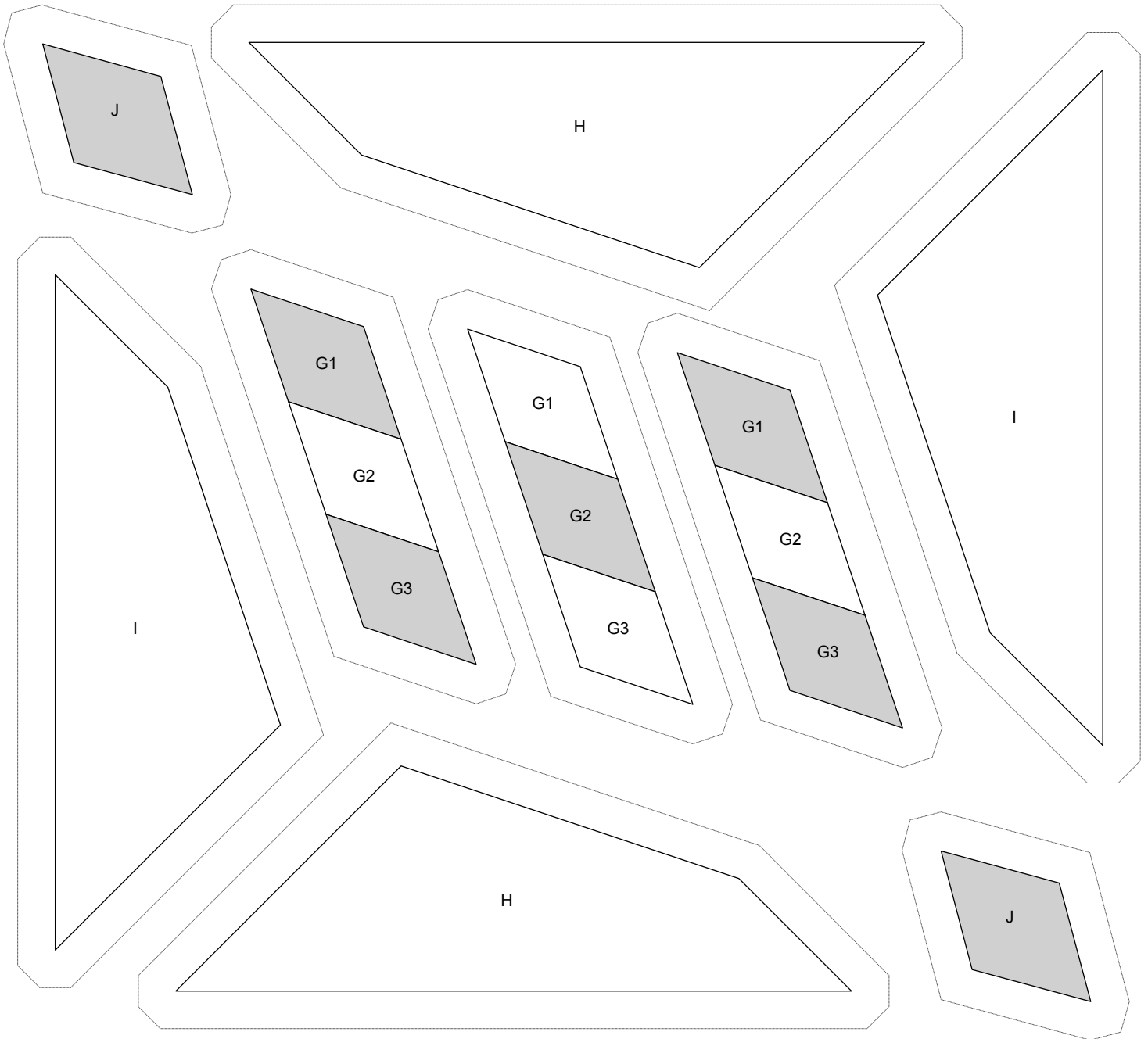

The Jane Stickle Quilt - Block C3



What you need:

Patches	Quantity/size
A*	(2) 1" x 6"
B*	(2) 1" x 5"
C	(4) 1¼" x 1¼" - navy (4) 1¼" x 1¼" - green (8) 1¼" x 1¼" - light blue
D	(4) 1¼" x 2" - gray (4) 1¼" x 2" - light blue
E	(1) 2" x 2"

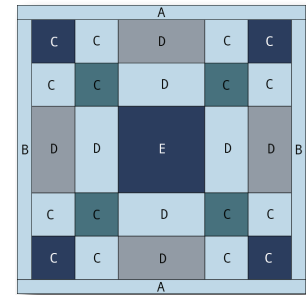

Hobbystash Colorway

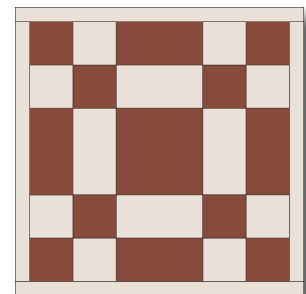

Jane Stickle Colorway

**The actual required width for Unit A and Unit B units is ¾". The increased width specified above allows for squaring the block to exactly 5½".*

Assembly:

1. Arrange two light blue Unit C, one navy Unit C, and one green Unit C as shown and sew together. Make four.
2. Arrange one gray and one light blue Unit D as shown and sew together. Make four.
3. Arrange two units from Step 1 and one unit from Step 2 as shown and sew together. Make two.
4. Arrange remaining two units from Step 2 with Unit E as shown and sew together.
5. Arrange units from Step 3 and Step 4 as shown and sew together.
6. Join Unit B to the right side of the block, and then the left.
7. Join Unit A to the top of the block and then the bottom. Square up block to measure 5½" x 5½"

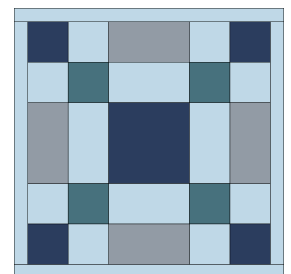
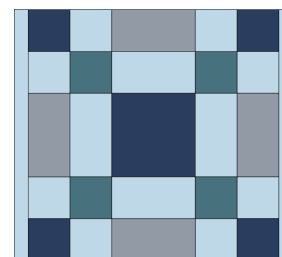
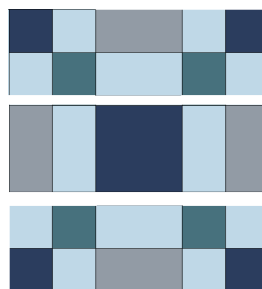
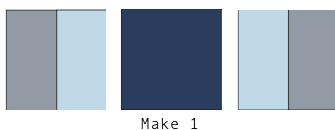
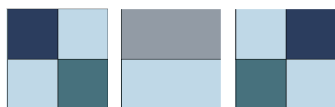

SET PRINTER TO "ACTUAL SIZE" WHEN PRINTING THIS PAGE.

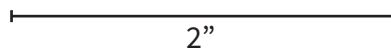
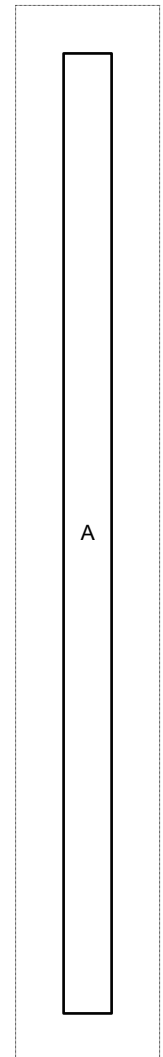
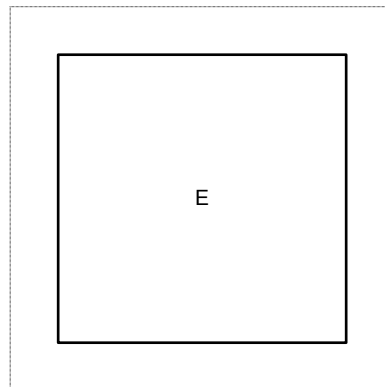
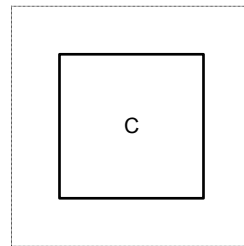
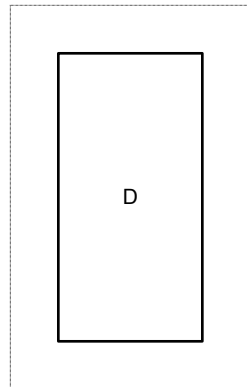
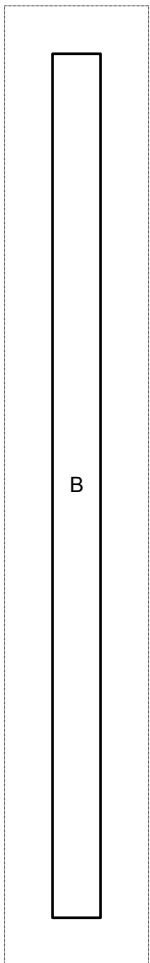
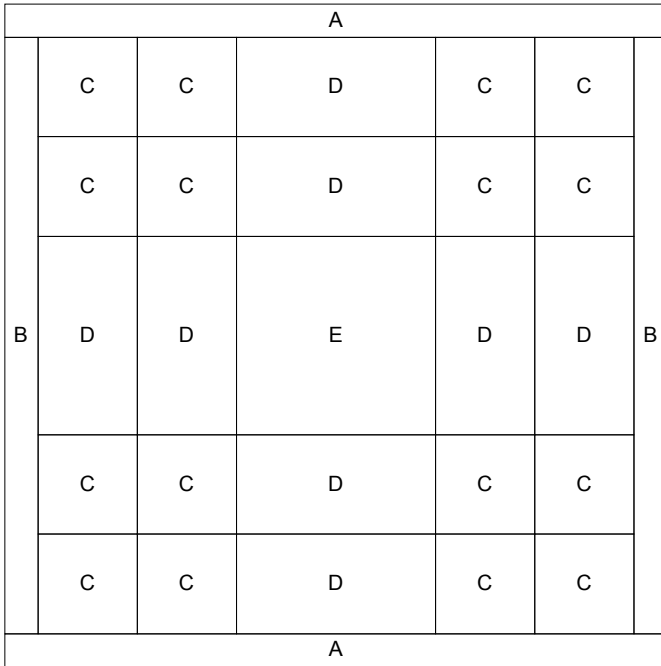

The Jane Stickle Quilt - Block C4

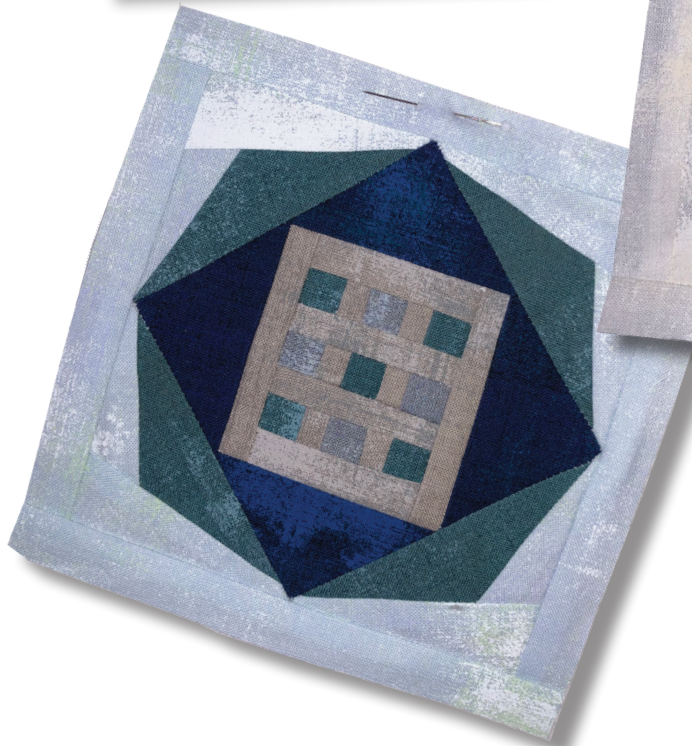

What you need:

Units	Quantity/size
A*	(2) 1" x 6"
B*	(2) 1" x 5"
C	(2) 1½" x 3½"
D	(2) 1½" x 3"
E	(2) 1½" x 3"
F	(2) 1½" x 3½"
G	(4) 2" x 4½"
H	(2) 1" x 3"
I	(2) 1" x 2½"
J	(5) 1¼" x 1¼" - green (4) 1¼" x 1¼" - gray
K	(2) 1" x 2½"
L	(6) 1" x 1¼"
M	(1) 4" x 4", cut twice diagonally

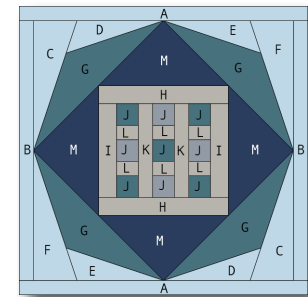

Hobbystash Colorway

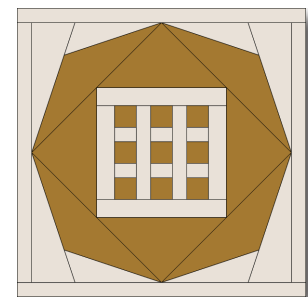

Jane Stickle Colorway

**The actual required width for Unit A and Unit B units is ¾". The increased specified width allows for squaring the block to exactly 5½".*

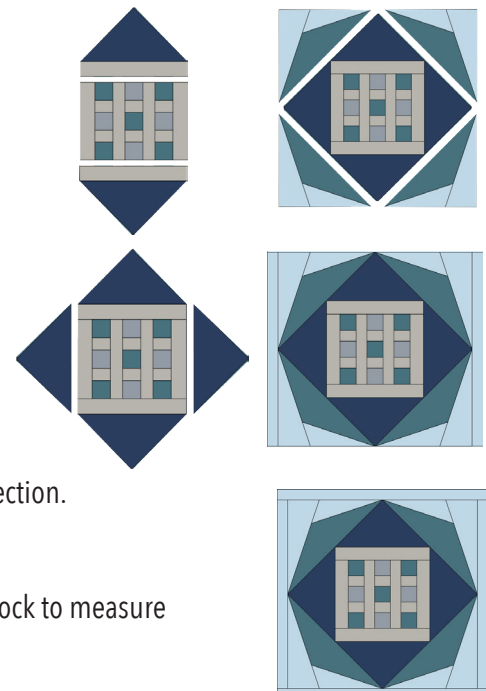

Assembly:

- Using the templates provided on Page C4-2, foundation piece each section.
- Join the sections together.
- Join Unit B to the right side of the block, and then the left.
- Join Unit A to the top of the block and then the bottom. Square up block to measure 5½" x 5½"

SET PRINTER TO "ACTUAL SIZE" WHEN PRINTING THIS PAGE.

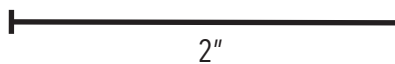
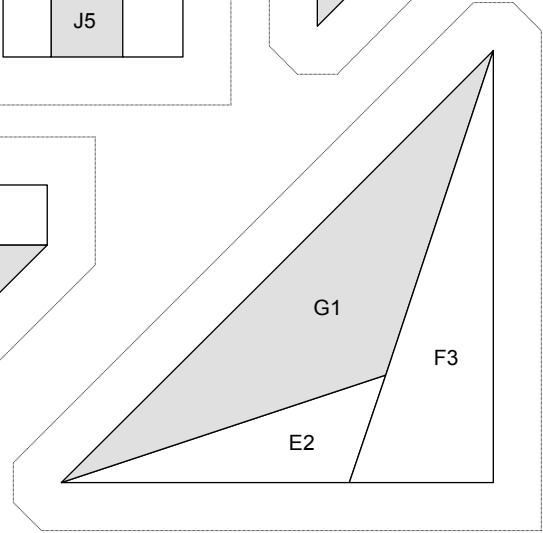
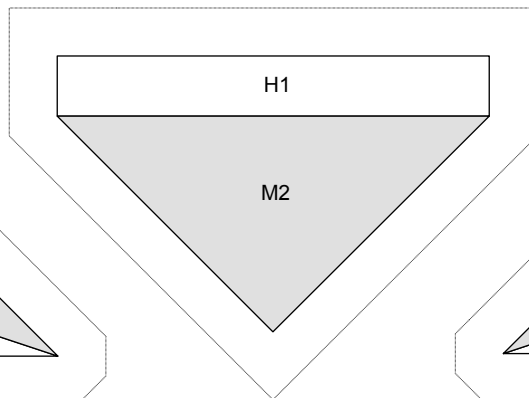
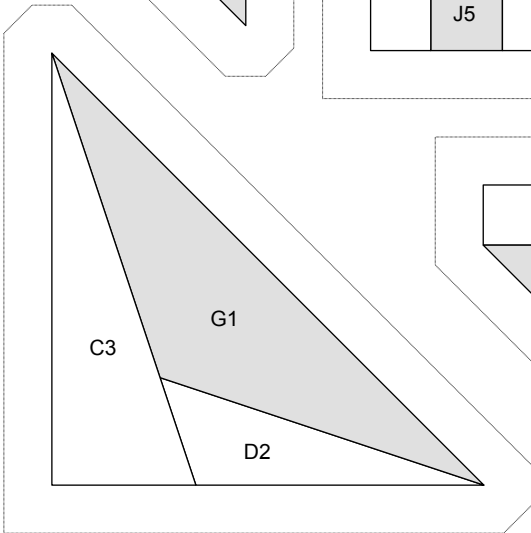
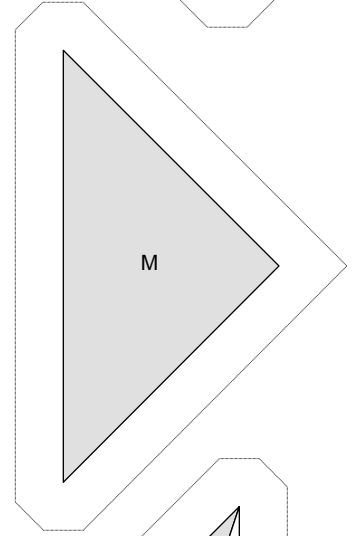
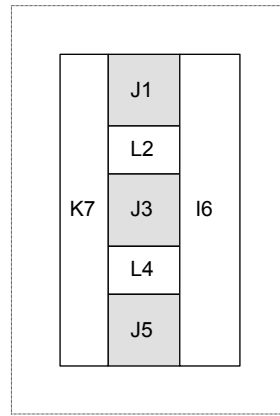
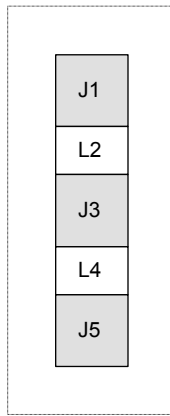
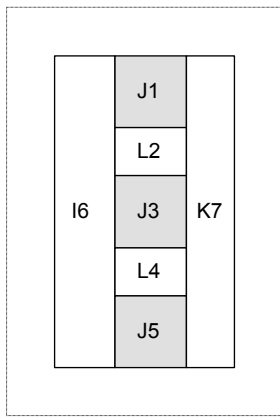
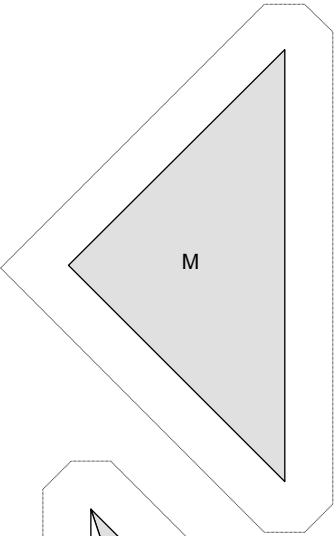
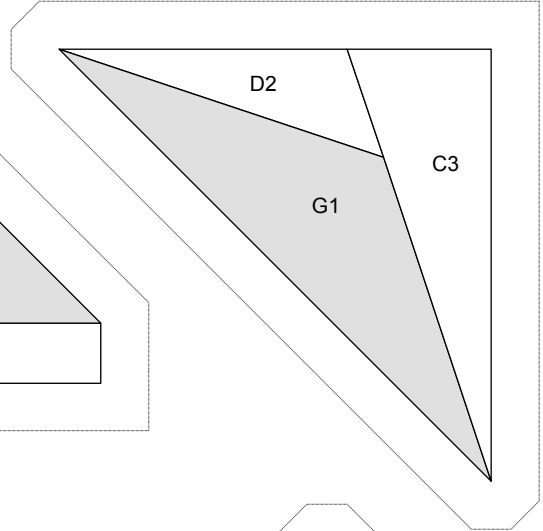
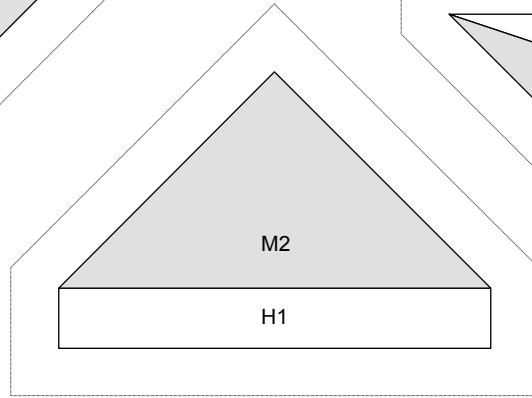
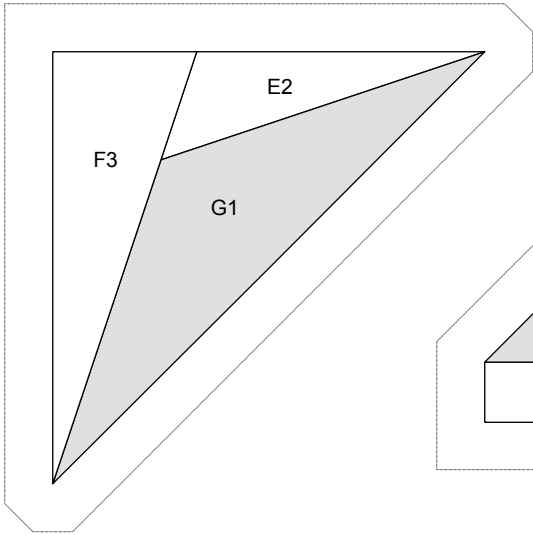

SET PRINTER TO "ACTUAL SIZE" WHEN PRINTING THIS PAGE.

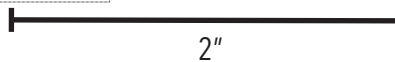
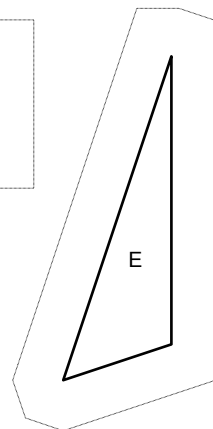
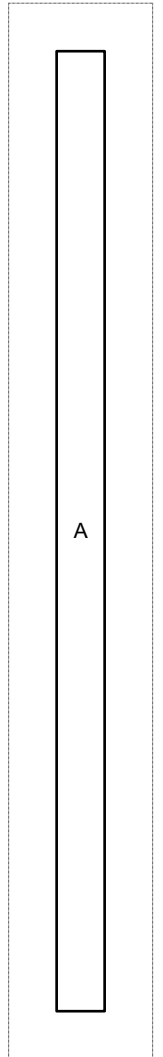
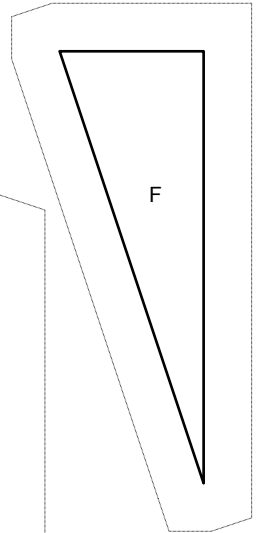
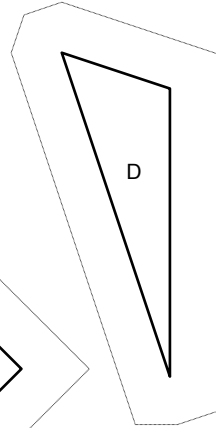
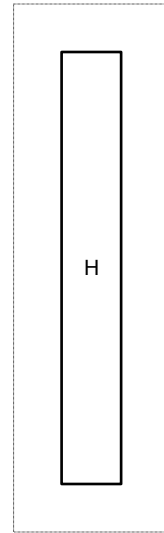
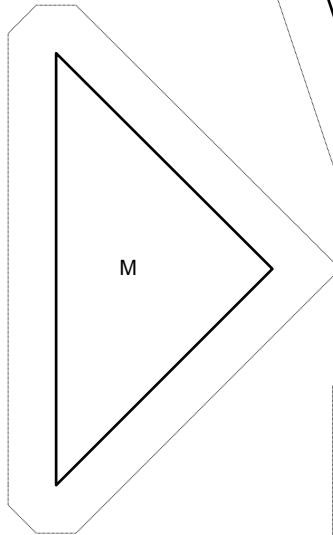
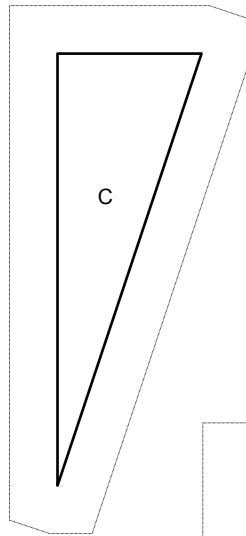
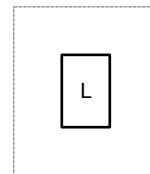
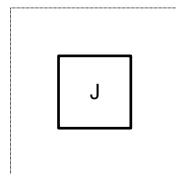
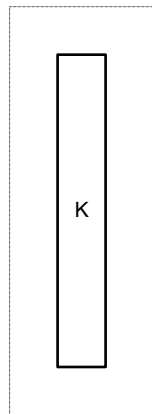
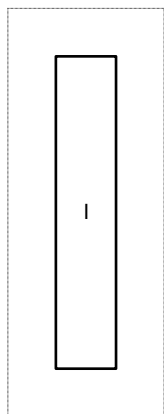
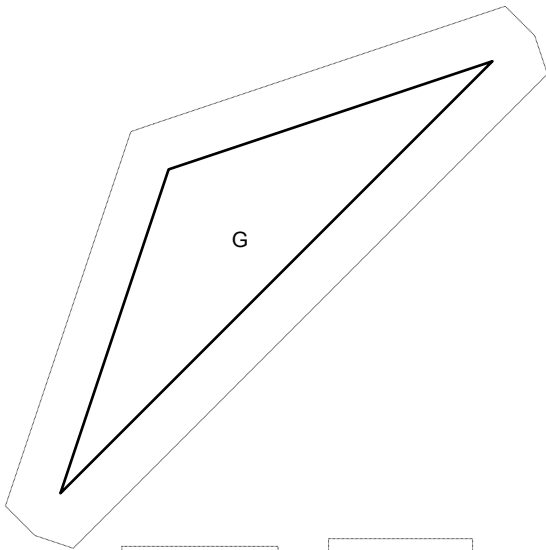
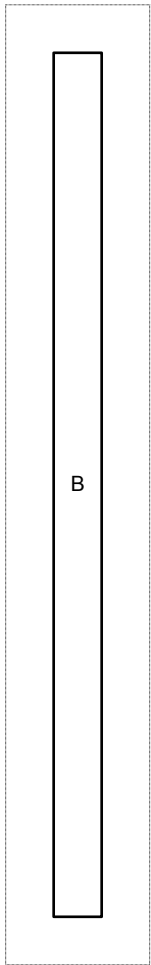
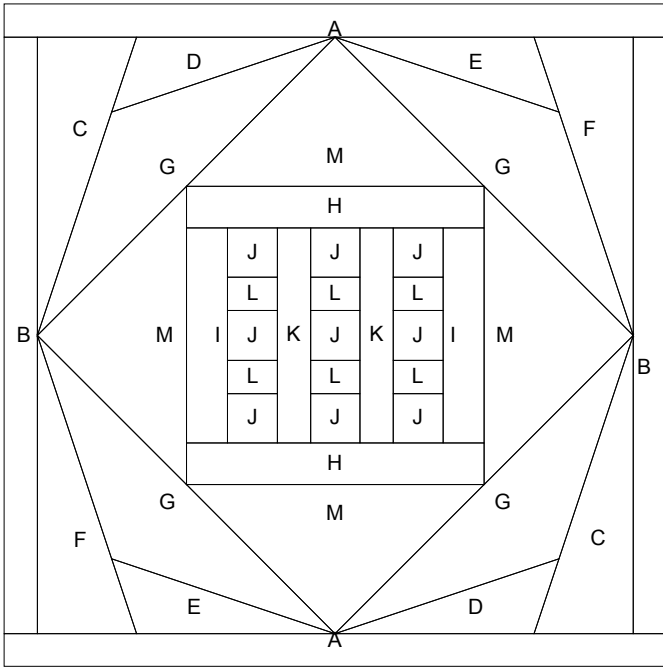

The Jane Stickle Quilt - Block C5

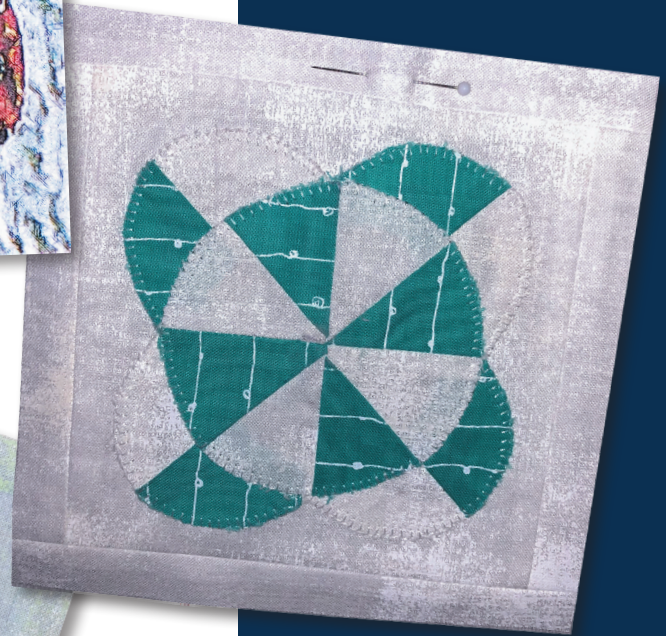
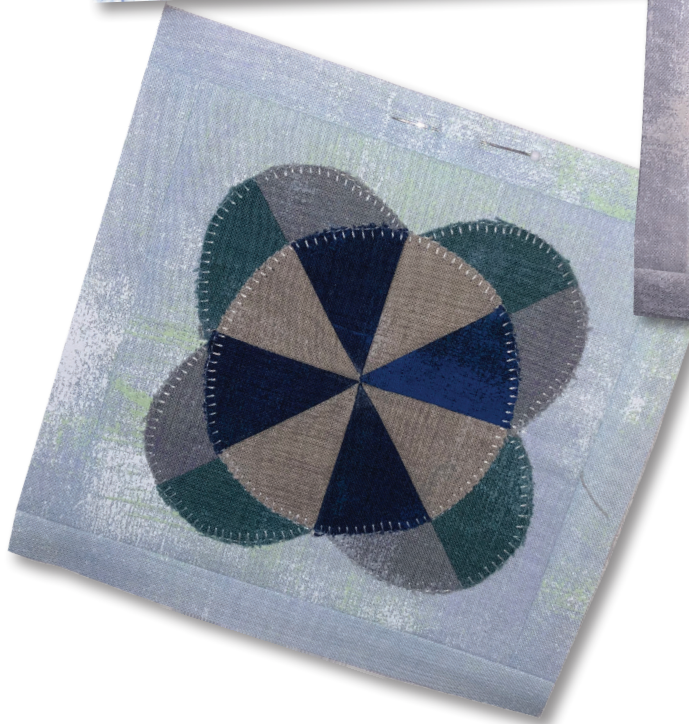

What you need:

Units	Quantity/size
A*	(2) 1" x 6"
B*	(2) 1" x 5"
C	(1) 6" x 6"
D	(2) 3½" x 3½"
E	(2) 3½" x 3½"
F	(2) 3½" x 3½" - beige (2) 3½" x 3½" - navy

*The actual required width for Unit A and Unit B units is ¾". The increased width specified above allows for squaring the block to exactly 5½".

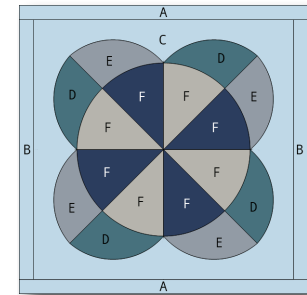

Hobbystash Colorway

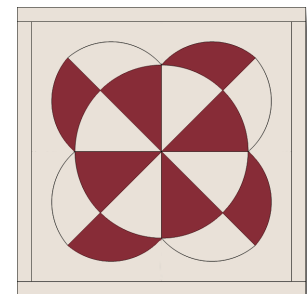

Jane Stickle Colorway

Assembly:

- Referring to BASIC INSTRUCTIONS for half-square triangles (HST) two at a time, use the green Unit D and the gray Unit E to make four HST units. Arrange the four HST units as illustrated and sew together.
- Using the template on page C5-2, cut clover shape from Step 1 patch. Appliqué patch to Unit C.
- Repeat the HST process using the beige Unit F and the navy Unit F to make four HST units. Arrange the four HST units as illustrated and sew together.
- Using the circle template on Page C5-2, cut a circle from the Step 3 HST patch. Arrange and appliqué the cut circle patch on top of the appliqué patch from Step 2. Square block to 5" x 5".
- Join Unit B to the right side of the block, and then the left.
- Join Unit A to the top of the block and then the bottom. Square up block to measure 5½" x 5½"

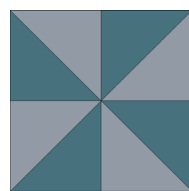

Step 1

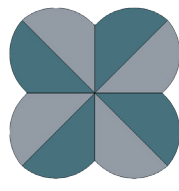

Step 2

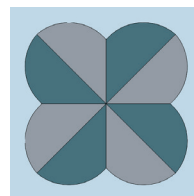

Step 2

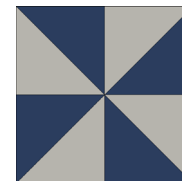

Step 3

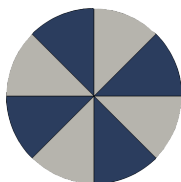

Step 4

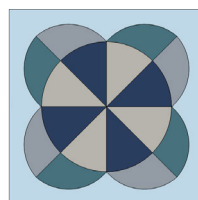

Step 4

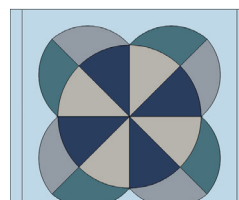

Step 5

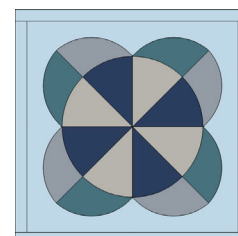

Step 6

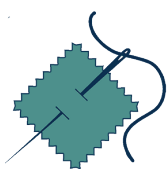

SET PRINTER TO "ACTUAL SIZE" WHEN PRINTING THIS PAGE.

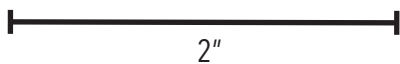
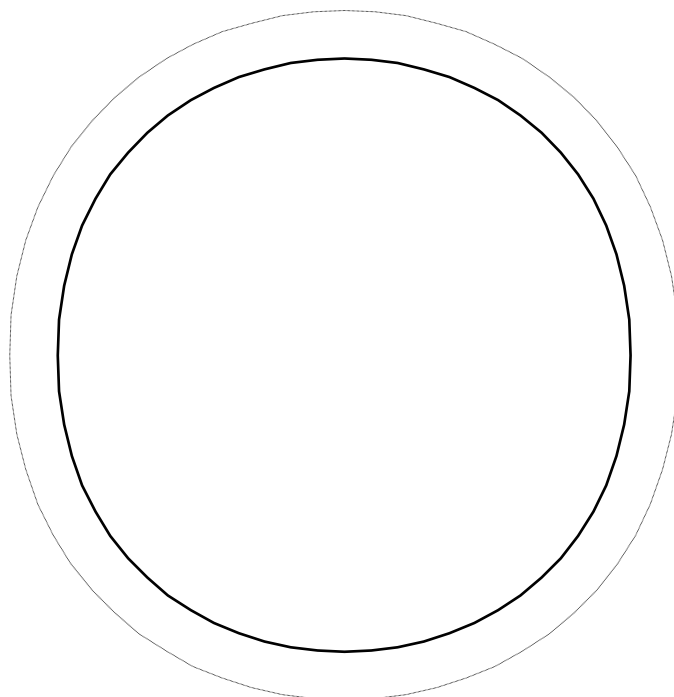
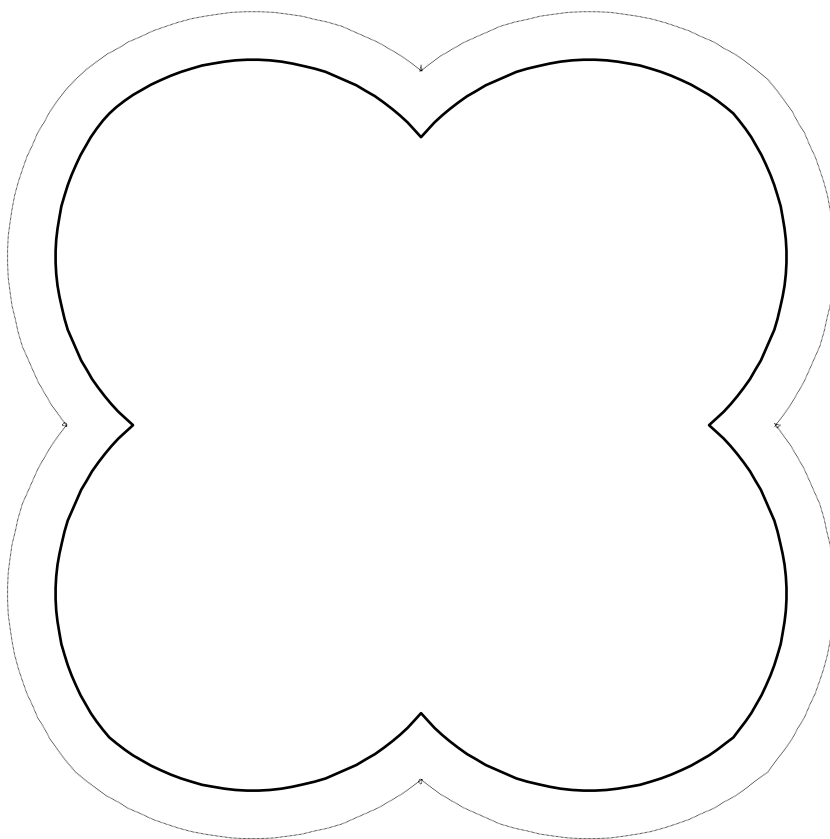

SET PRINTER TO "ACTUAL SIZE" WHEN PRINTING THIS PAGE.

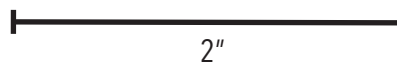
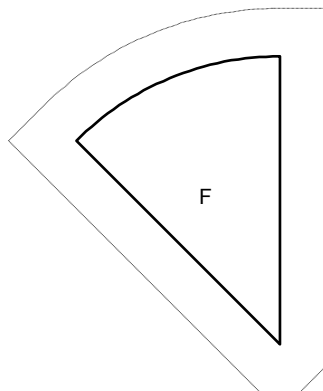
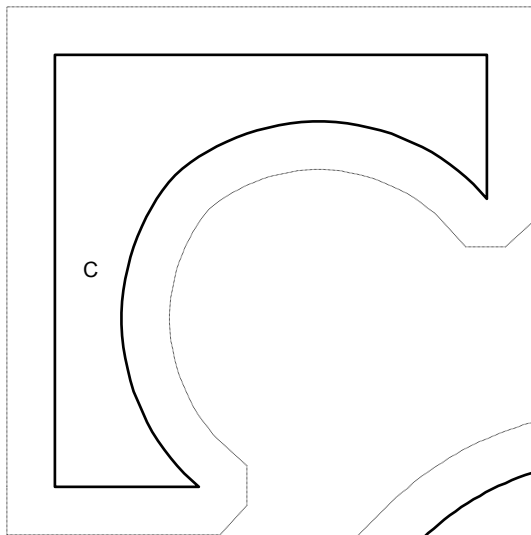
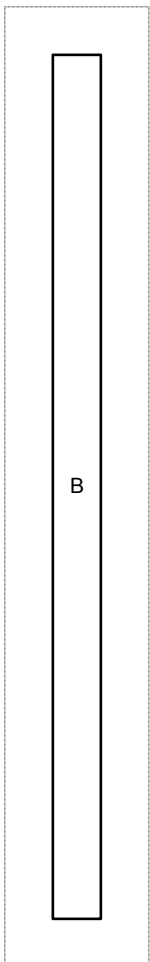
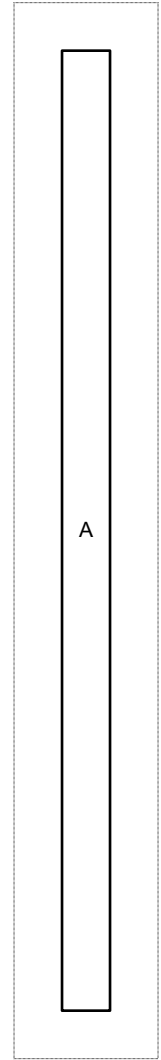
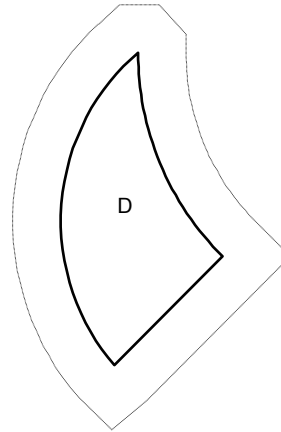
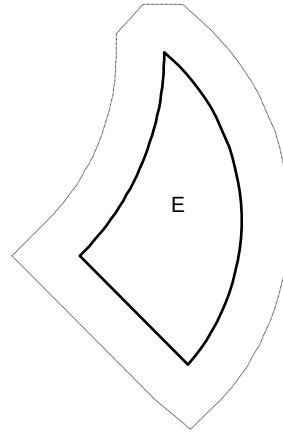
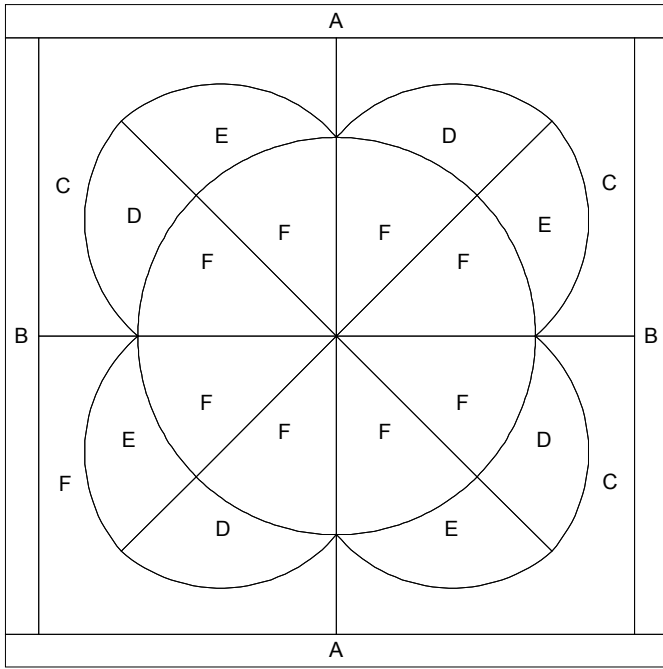

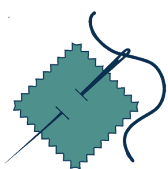

SET PRINTER TO "ACTUAL SIZE" WHEN PRINTING THIS PAGE.

After studying Jane's original block, it appears she curve pieced the sections together. Templates below can be used to assist with that process. Once fabrics have been sewn to the templates, remove the paper before joining the curved sections together.

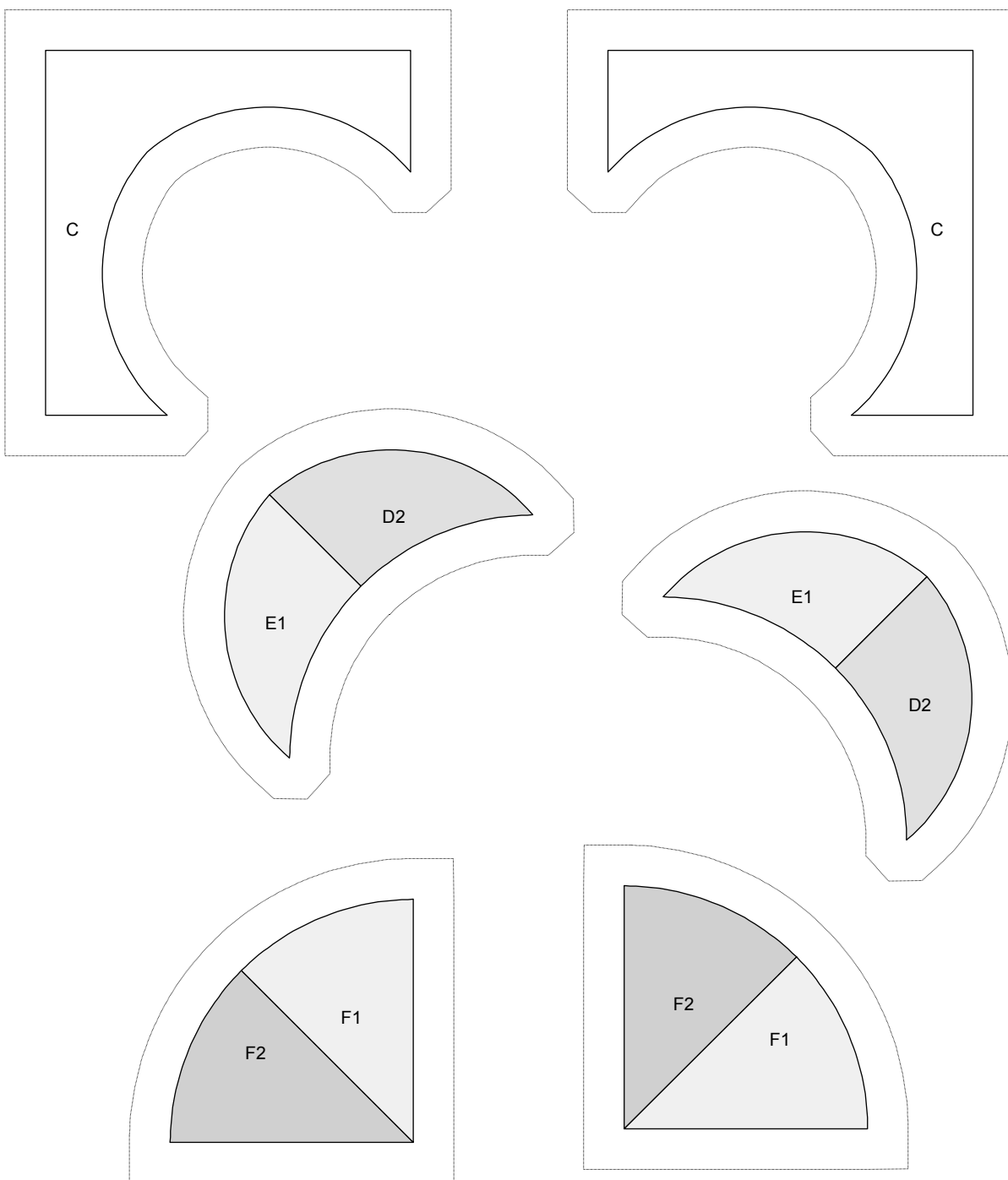

2"

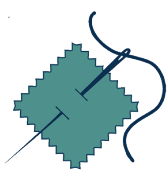

SET PRINTER TO "ACTUAL SIZE" WHEN PRINTING THIS PAGE.

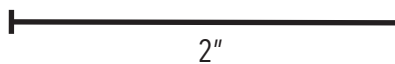
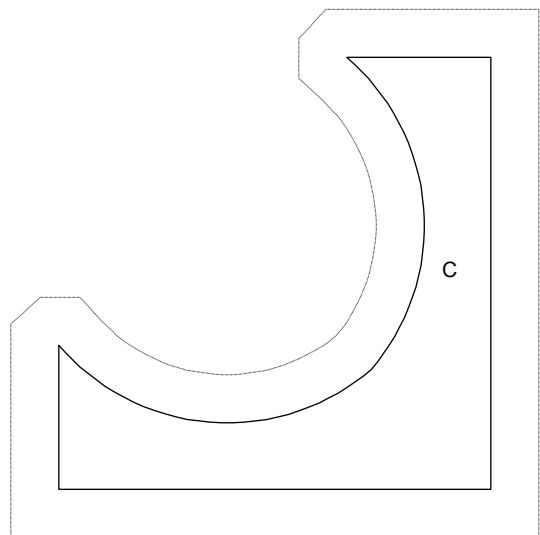
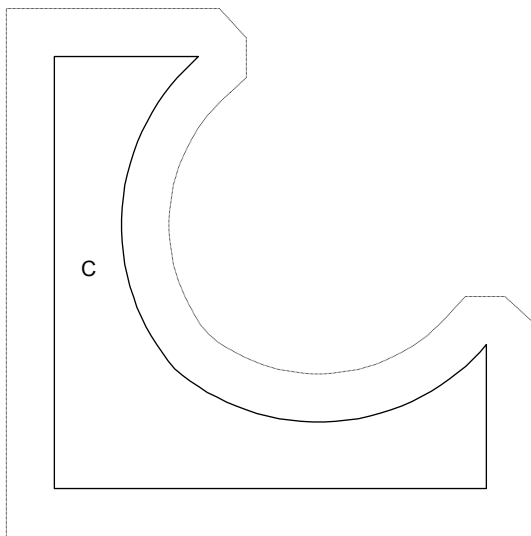
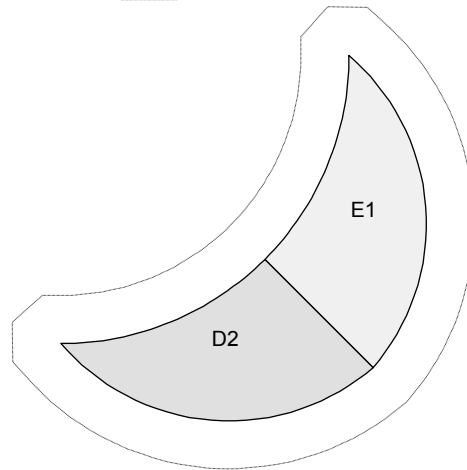
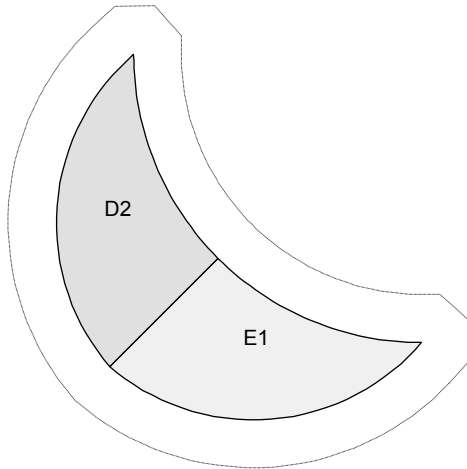
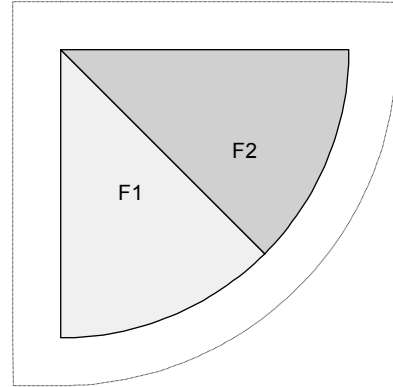
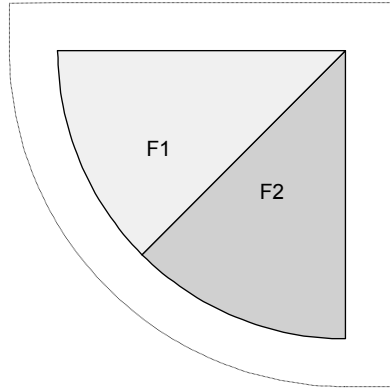

The Jane Stickle Quilt - Block C6



What you need:

Patches	Quantity/size
A*	(2) 1" x 6"
B*	(2) 1" x 5"
C	(1) 6" x 6"
D	(4) 2" x 4"

**The actual required width for Unit A and Unit B units is ¾". The increased width specified above allows for squaring the block to exactly 5½".*

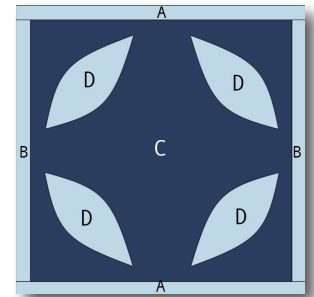

Hobbystash Colorway

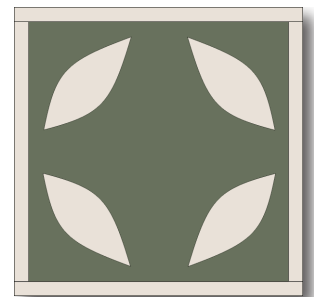

Jane Stickle Colorway

Assembly:

1. Using the templates provided on page C6-2, appliqué the four leaf units to Unit C of the block. When all the leaves have been appliquéd to Square C, trim the block to 5" x 5" square.
2. Join Unit B to the right side of the block, and then the left.
3. Join Unit A to the top of the block and then the bottom. Square up block to measure 5½" x 5½".

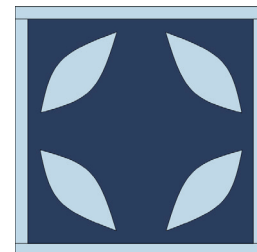

SET PRINTER TO "ACTUAL SIZE" WHEN PRINTING THIS PAGE.

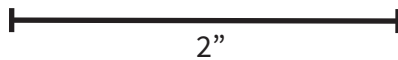
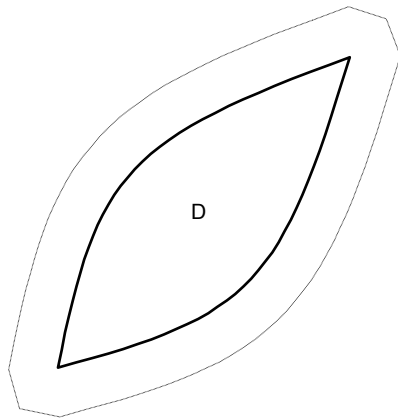

SET PRINTER TO "ACTUAL SIZE" WHEN PRINTING THIS PAGE.

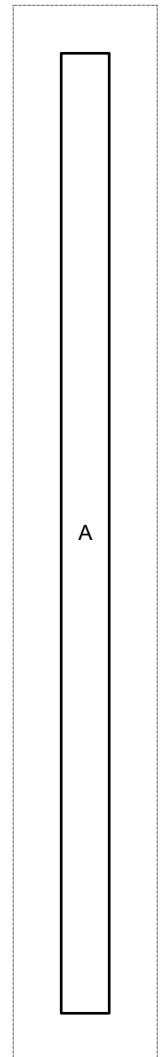
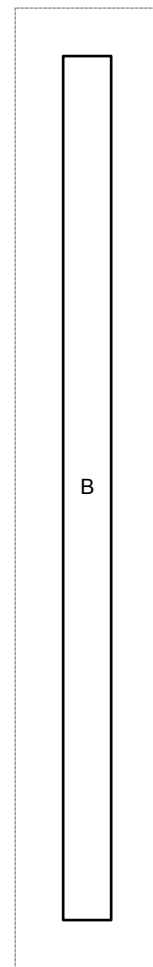
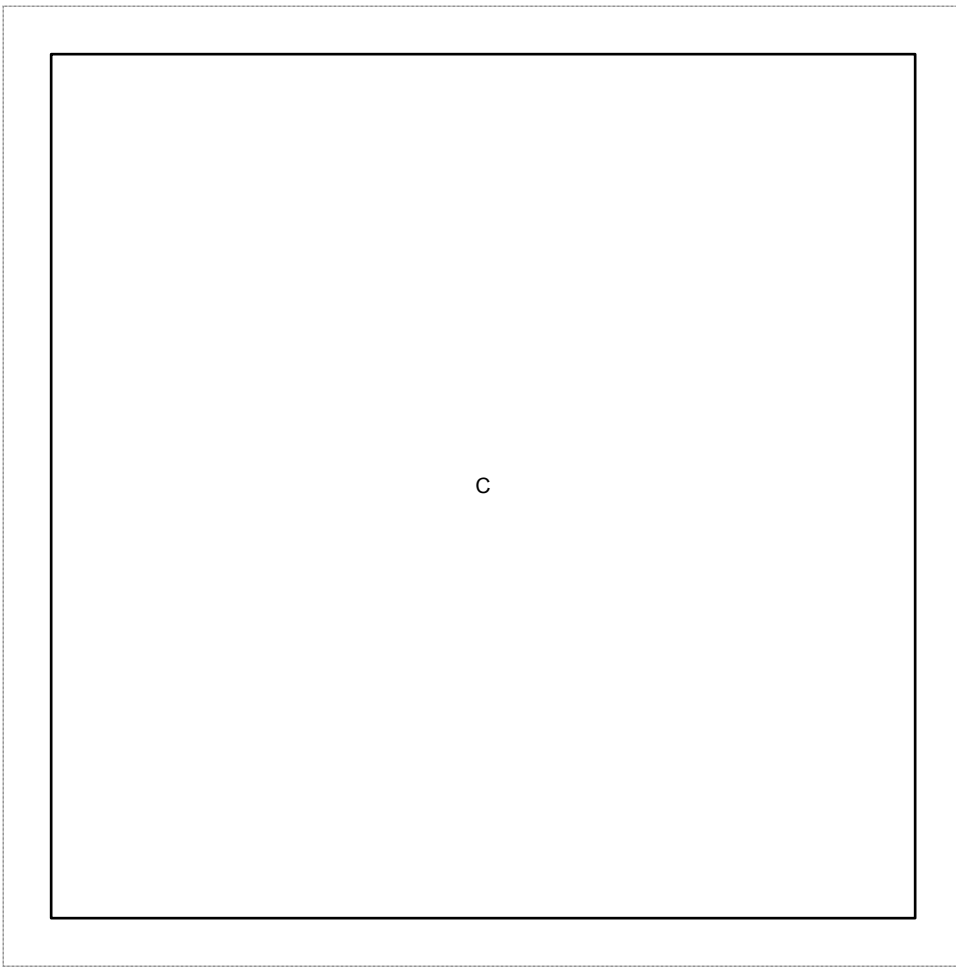
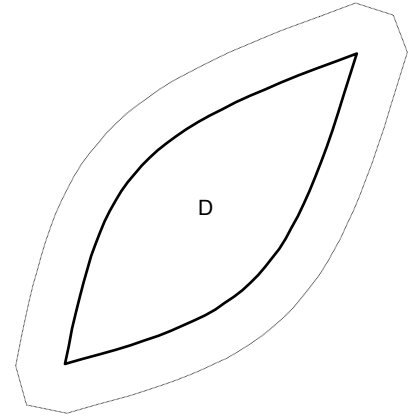
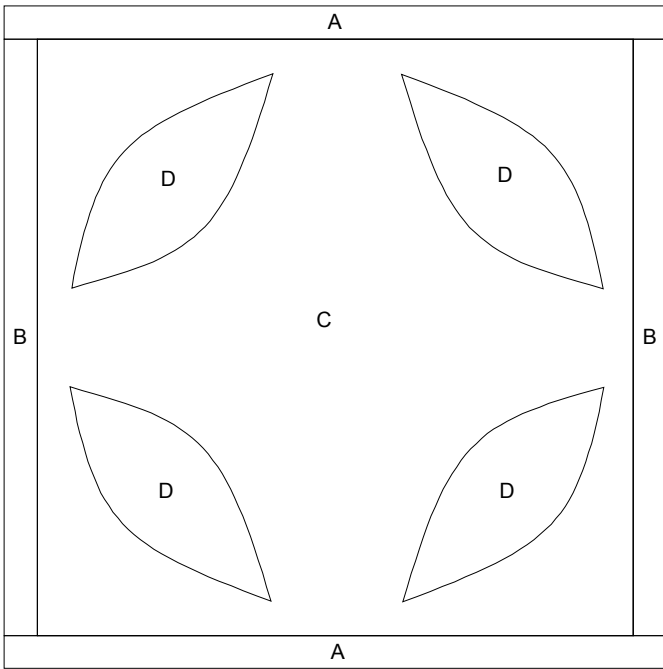

The Jane Stickle Quilt - Block C7

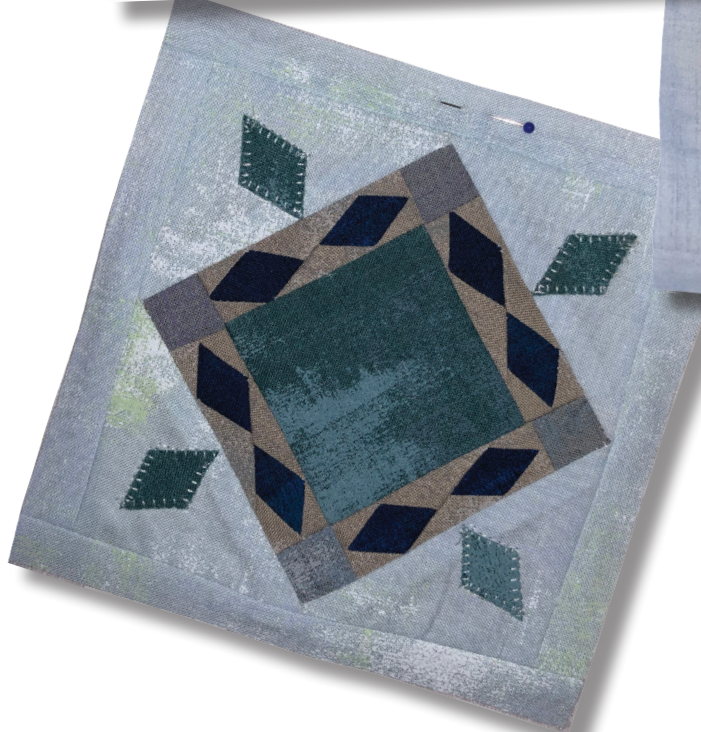

What you need:

Units	Quantity/size
A*	(2) 1" x 6"
B*	(2) 1" x 5"
C	(2) 3½" x 3½", cut once diagonally
D	(4) 1½" x 1½"
E	(4) 1½" x 2", cut once diagonally
F	(8) 1½" x 3"
G	(4) 1½" x 2", cut once diagonally
H	(1) 3" x 3"
I	(12) 1½" x 1½"

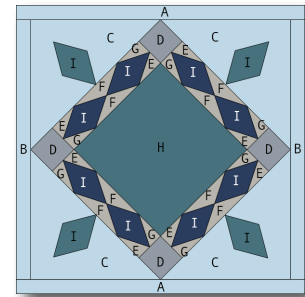

Hobbystash Colorway

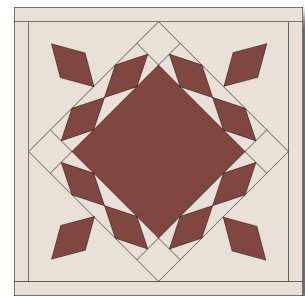

Jane Stickle Colorway

**The actual required width for Unit A and Unit B units is ¾". The increased specified width allows for squaring the block to exactly 5½".*

Assembly:

1. Using the templates provided on Page C7-2, foundation piece each section.
2. Join the sections together.
3. Join Unit B to the right side of the block, and then the left.
4. Join Unit A to the top of the block and then the bottom. Square up block to measure 5½" x 5½"

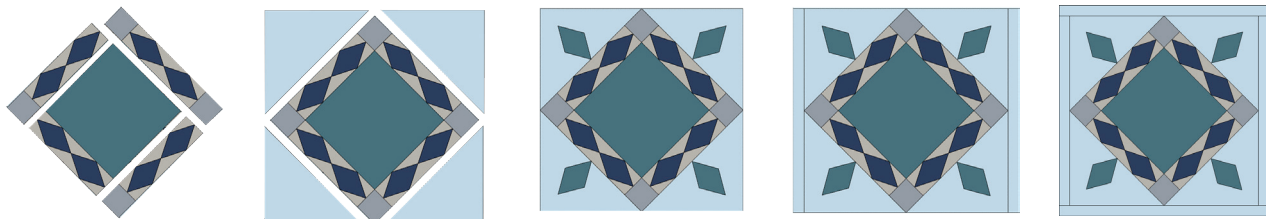

SET PRINTER TO "ACTUAL SIZE" WHEN PRINTING THIS PAGE.

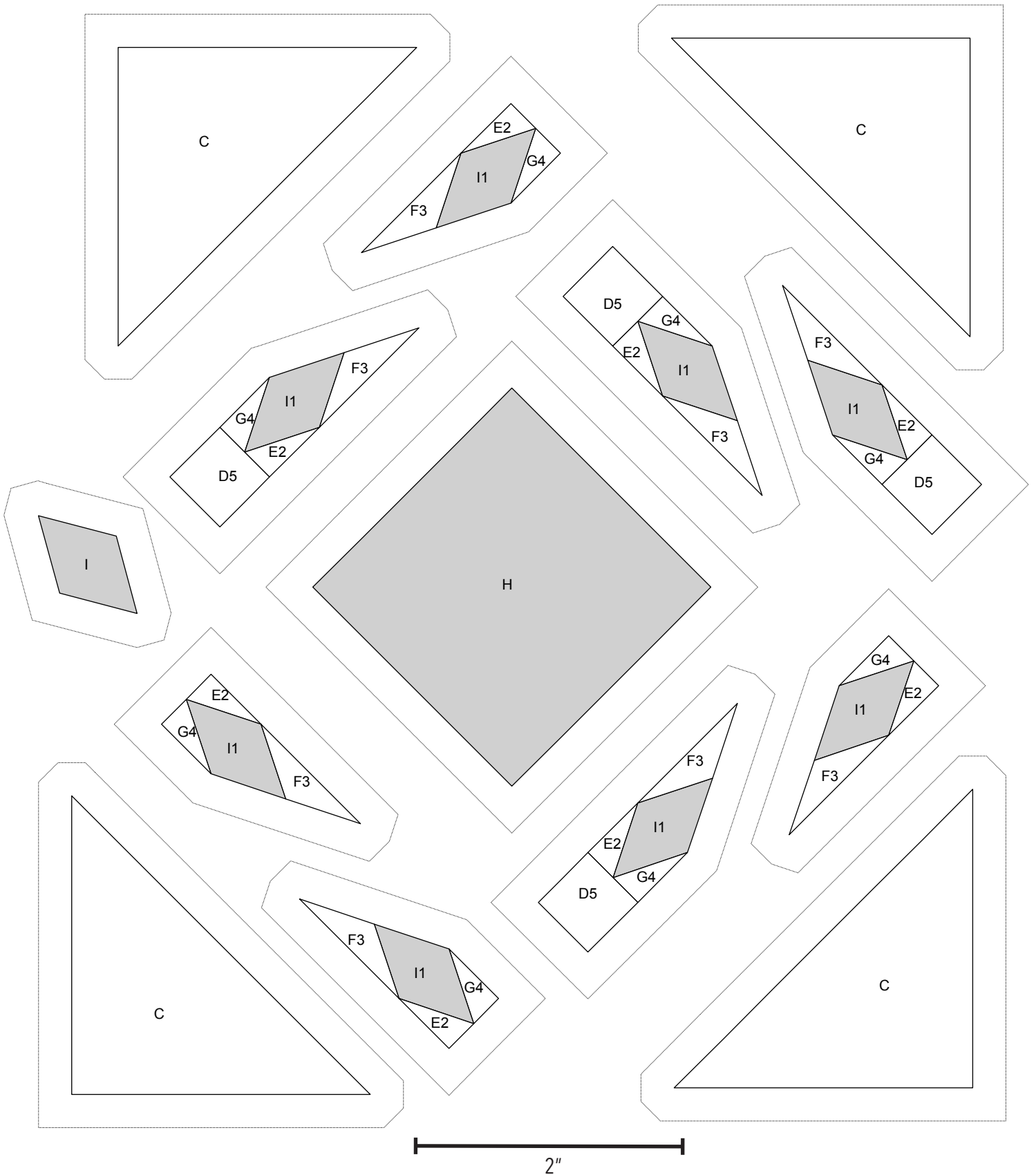

SET PRINTER TO "ACTUAL SIZE" WHEN PRINTING THIS PAGE.

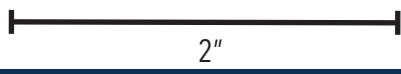
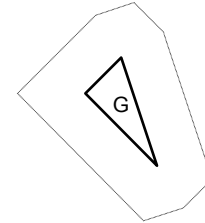
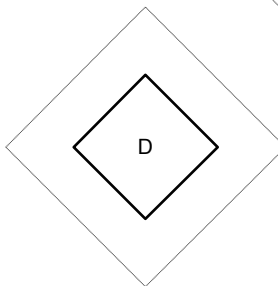
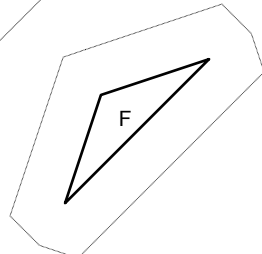
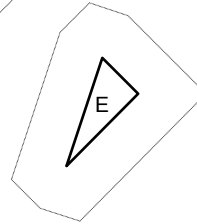
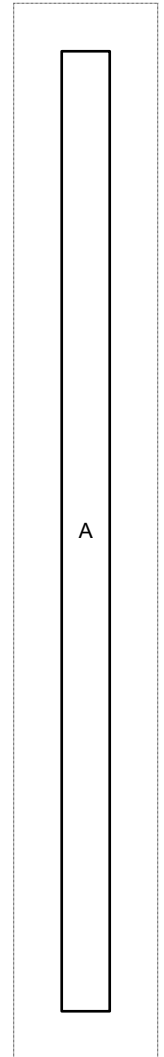
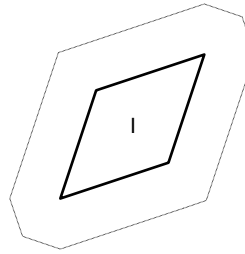
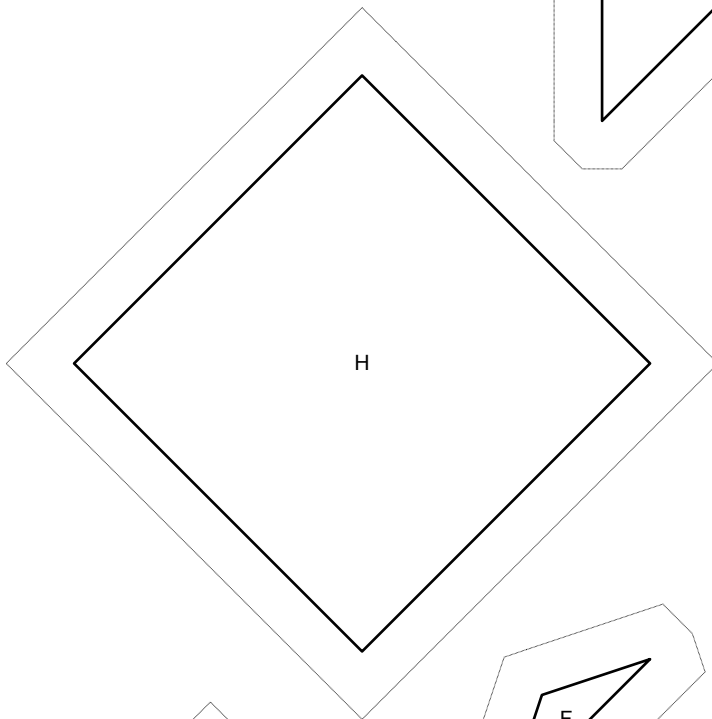
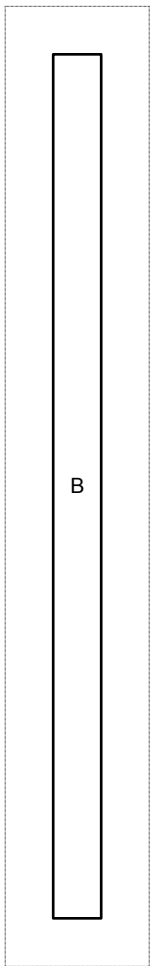
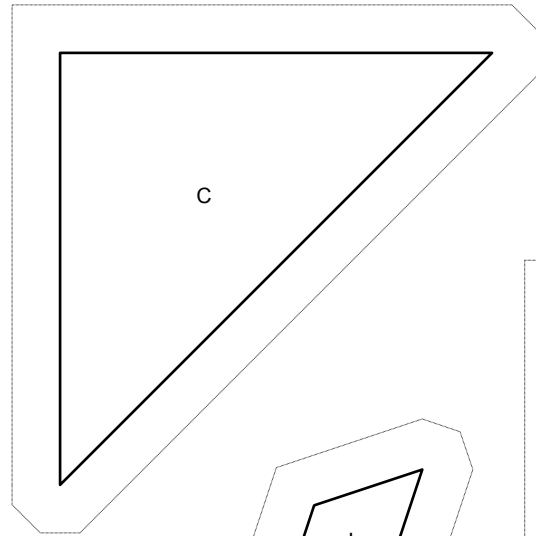
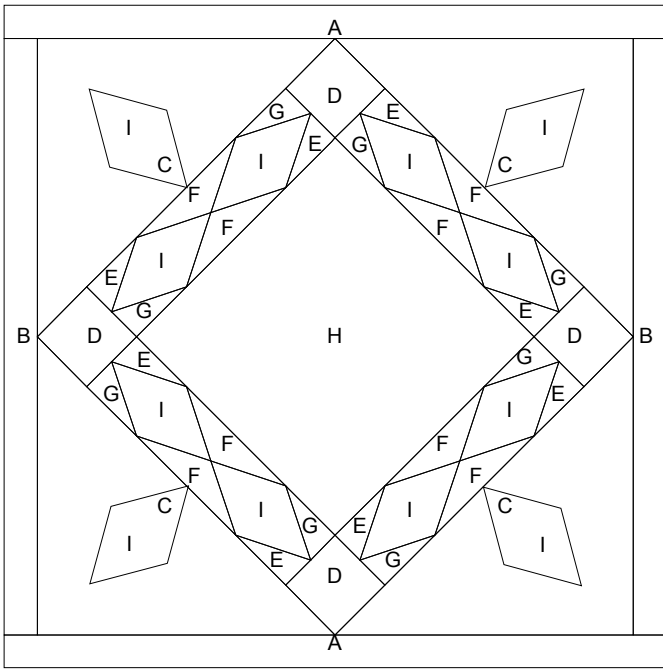

The Jane Stickle Quilt - Block C8



What you need:

Units	Quantity/size
A*	(2) 1" x 6"
B*	(2) 1" x 5"
C	(1) 4" x 4", cut once diagonally
D	(1) 4" x 4", cut once diagonally
E	(2) 2½" x 2½", cut once diagonally
F	(2) 2½" x 2½", cut once diagonally
G	(4) 1" x 2"
H	(2) 2" x 2", cut once diagonally
I	(1) 2" x 2"

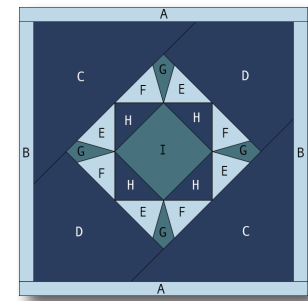

Hobbystash Colorway

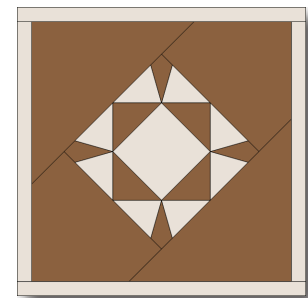

Jane Stickle Colorway

**The actual required width for Unit A and Unit B units is ¾". The increased specified width allows for squaring the block to exactly 5½".*

Assembly:

1. Using the templates provided on Page C8-2, foundation piece each section.
2. Join the sections together.
3. Join Unit B to the right side of the block, and then the left.
4. Join Unit A to the top of the block and then the bottom. Square up block to measure 5½" x 5½"



SET PRINTER TO "ACTUAL SIZE" WHEN PRINTING THIS PAGE.

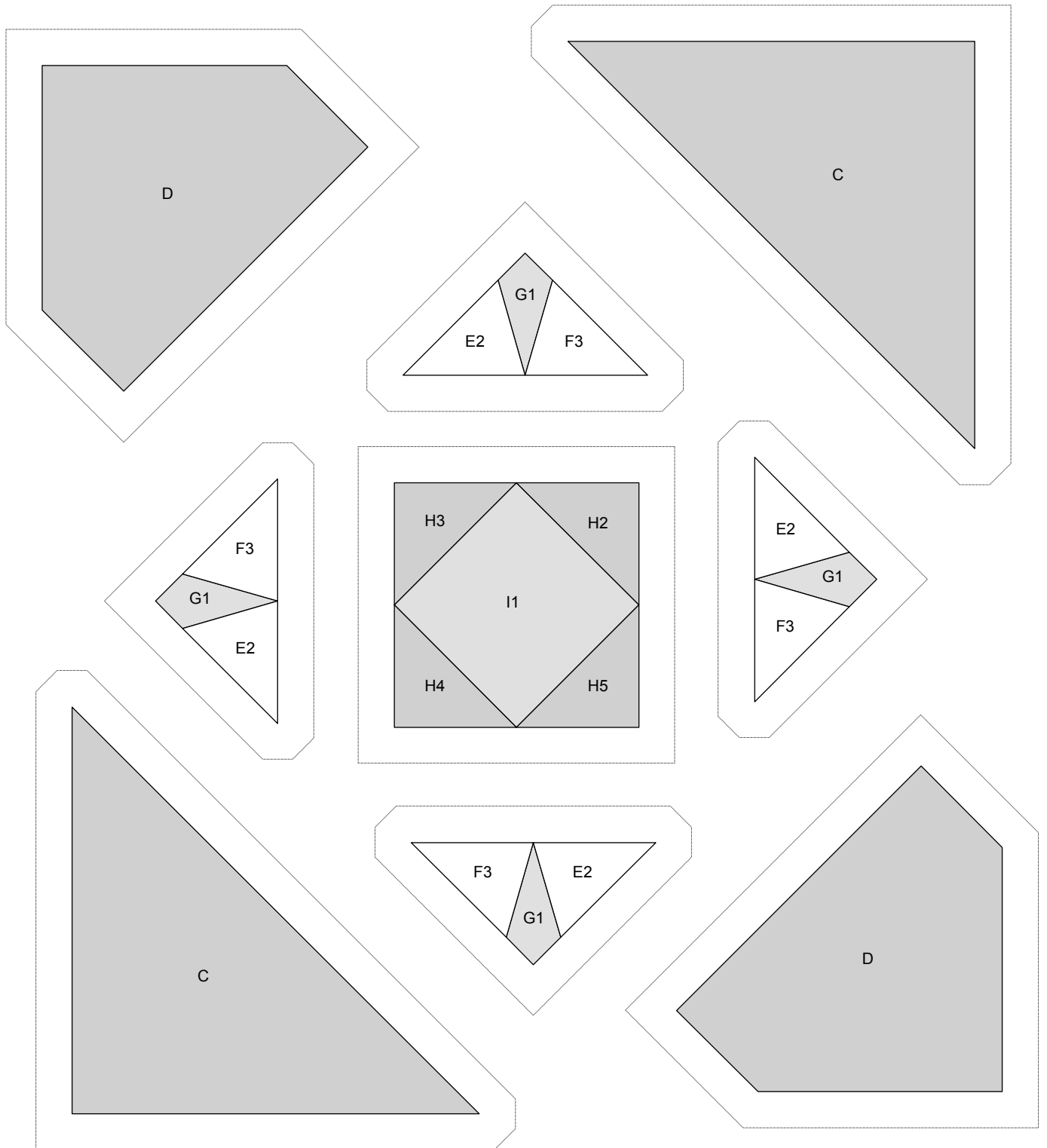

2"

SET PRINTER TO "ACTUAL SIZE" WHEN PRINTING THIS PAGE.

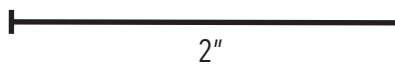
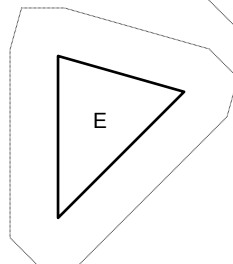
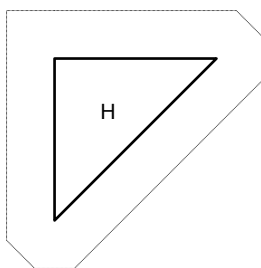
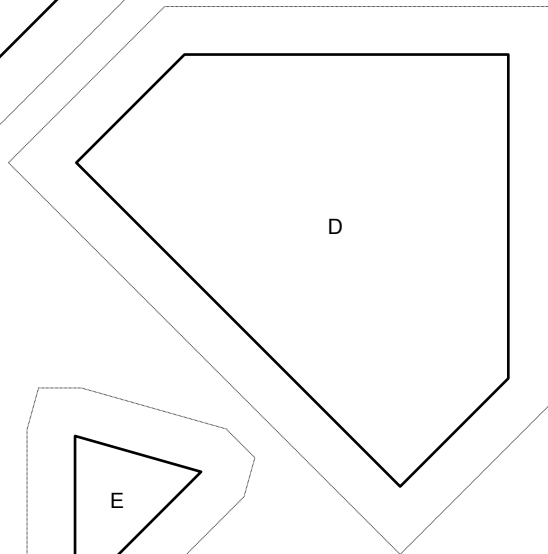
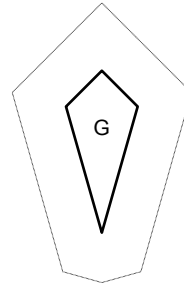
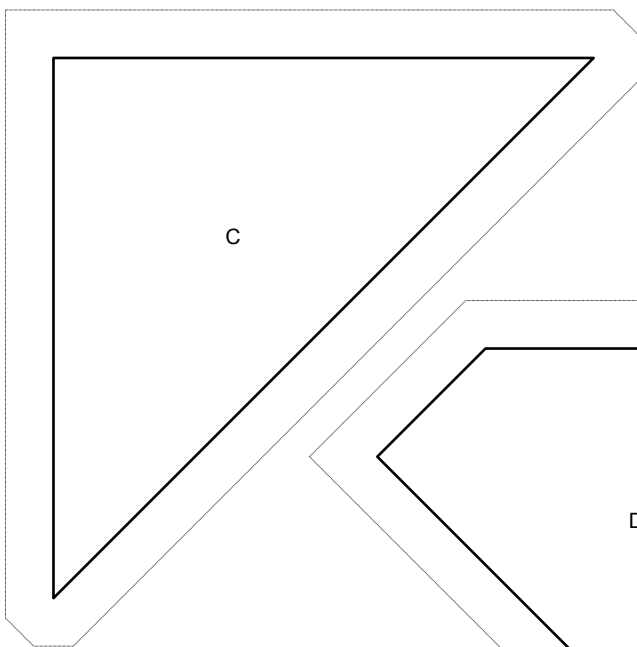
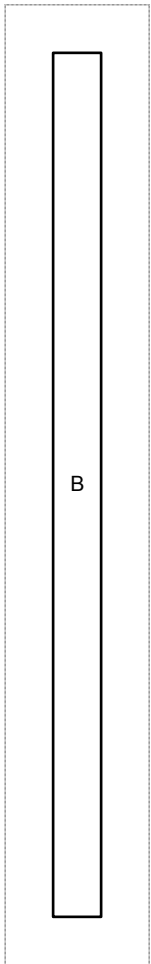
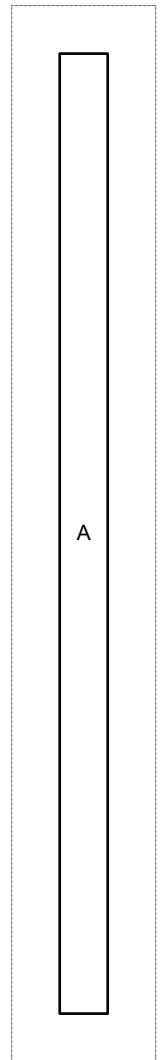
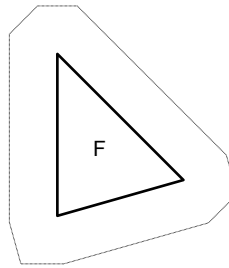
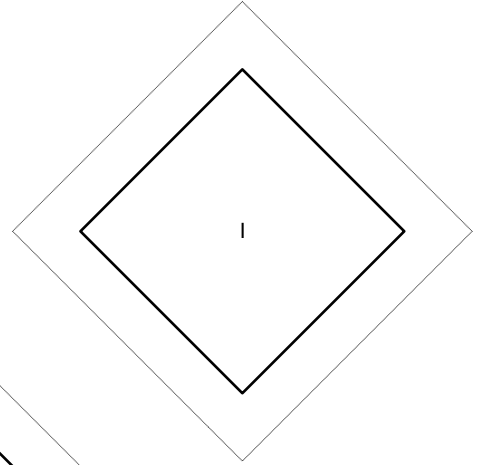
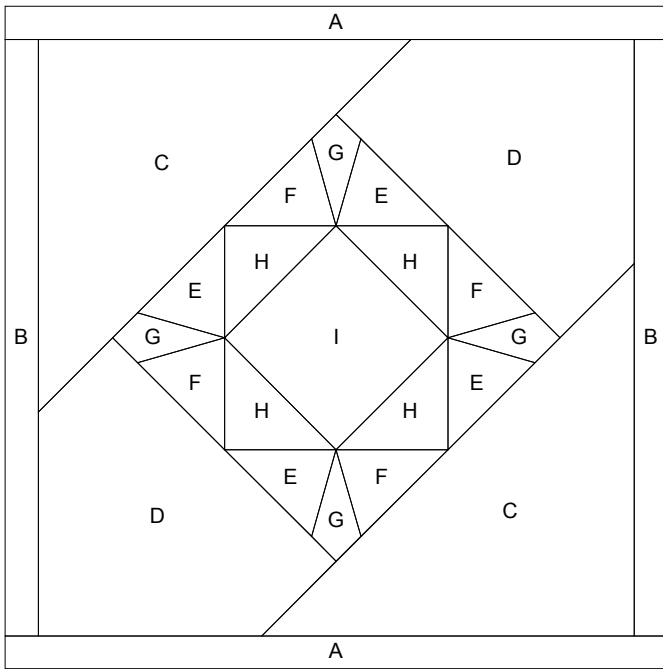

The Jane Stickle Quilt - Block C9



What you need:

Units	Quantity/size
A*	(2) 1" x 6"
B*	(2) 1" x 5"
C	(1) 5¾" x 5¾", cut twice diagonally
D	(4) 3" x 3"

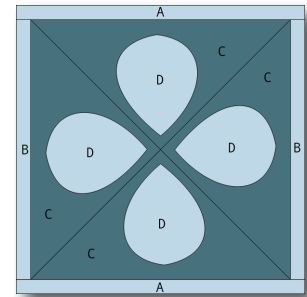

Hobbystash Colorway

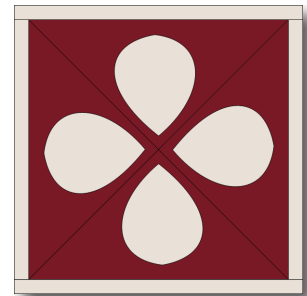

Jane Stickle Colorway

**The actual required width for Unit A and Unit B units is ¾". The increased specified width allows for squaring the block to exactly 5½".*

Assembly:

1. Assemble and sew together Unit C patches as shown.
2. Using template provided on Page C9-2, applique four teardrops to patch created in Step 1.
3. Join Unit B to the right side of the block, and then the left.
4. Join Unit A to the top of the block and then the bottom. Square up block to measure 5½" x 5½"

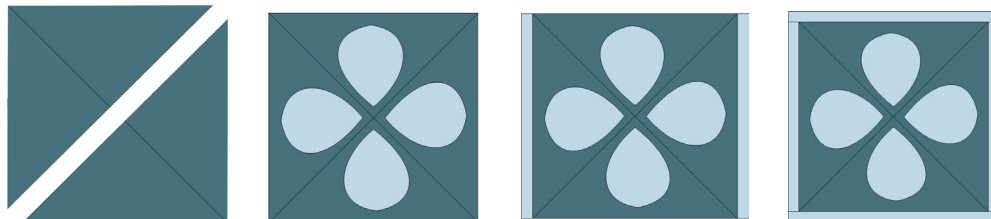

SET PRINTER TO "ACTUAL SIZE" WHEN PRINTING THIS PAGE.

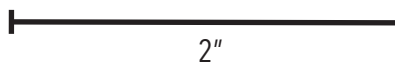
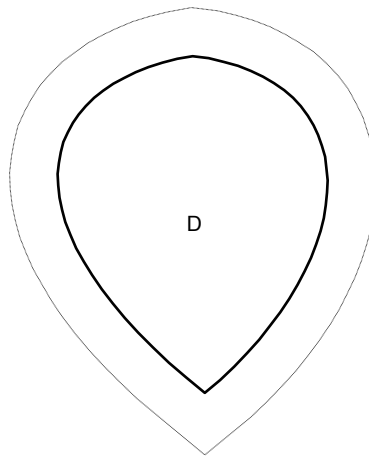

SET PRINTER TO "ACTUAL SIZE" WHEN PRINTING THIS PAGE.

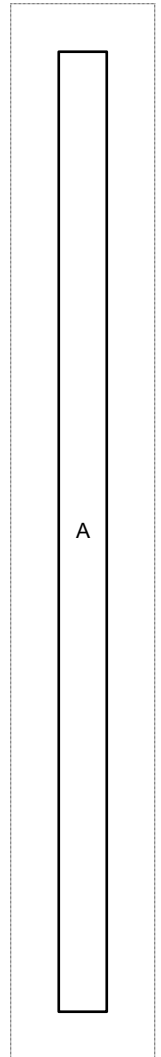
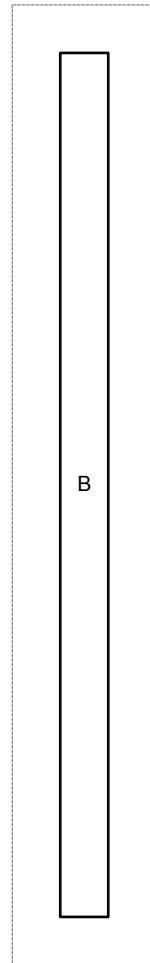
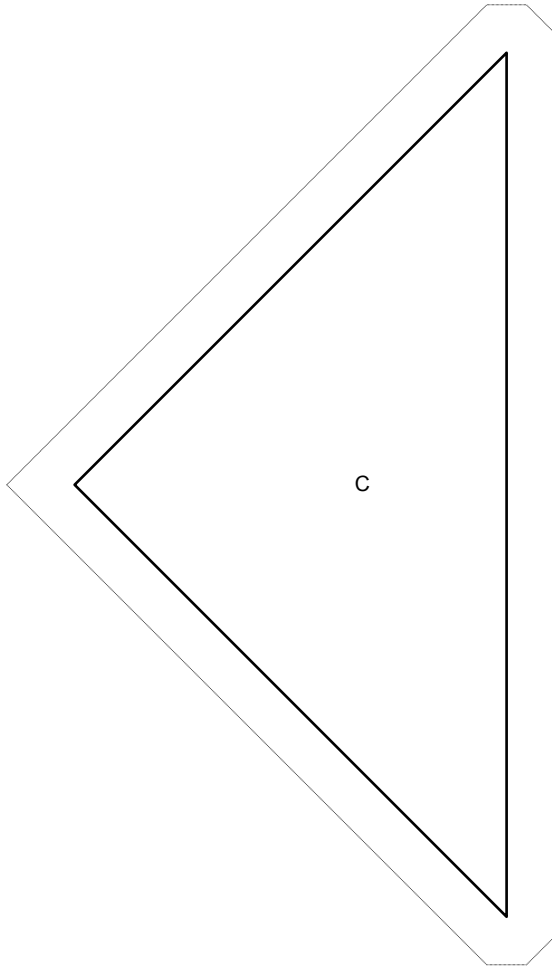
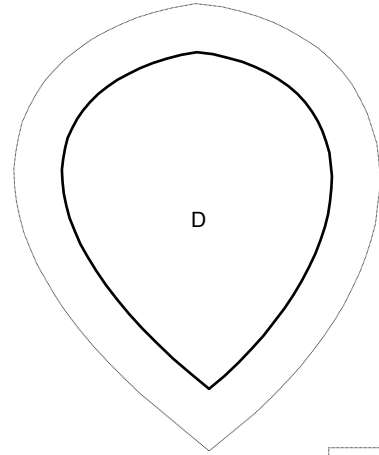
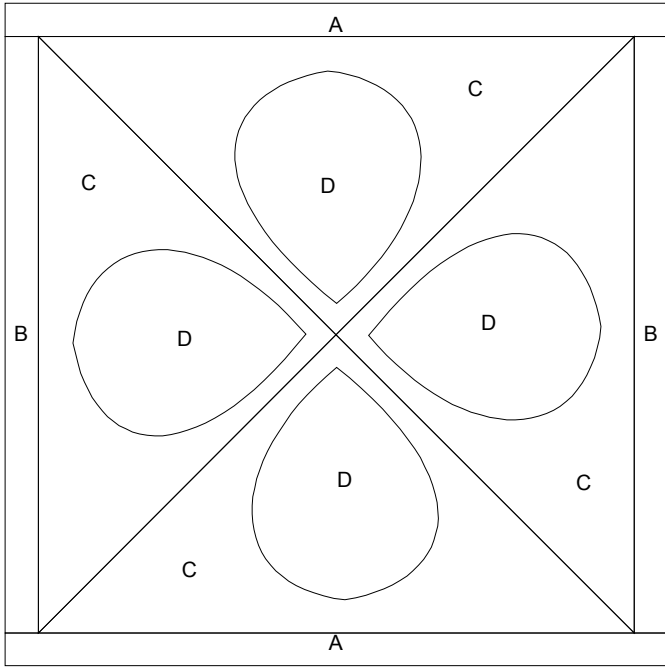

2"

The Jane Stickle Quilt - Block C10

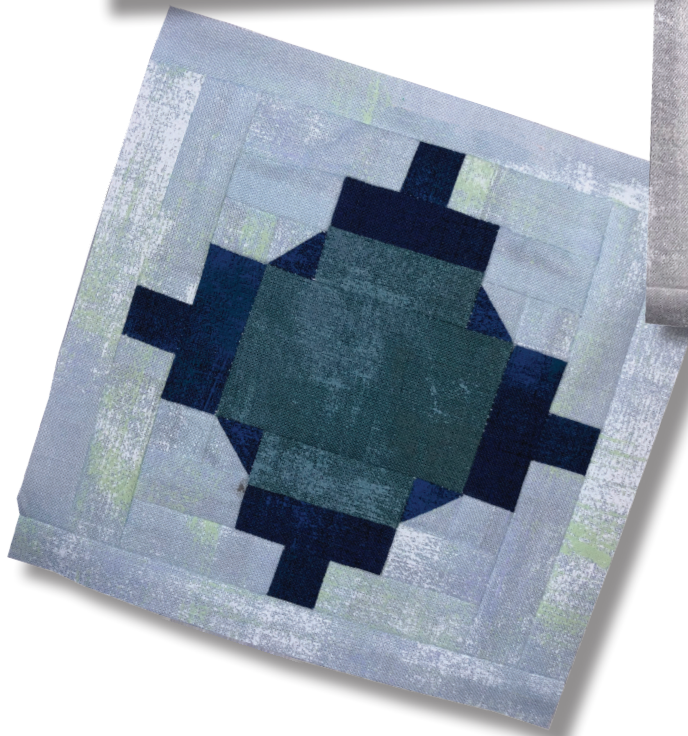
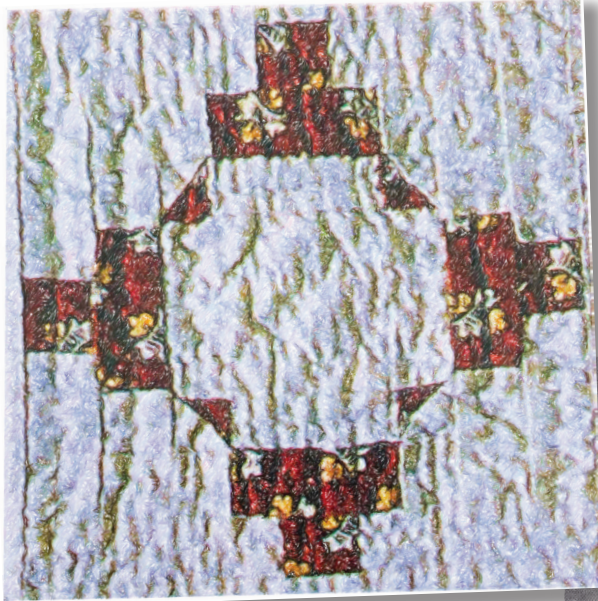

What you need:

Patches	Quantity/size
A*	(2) 1" x 6"
B*	(2) 1" x 5"
C	(4) 1½" x 3"
D	(4) 1½" x 2½" - light blue (2) 1½" x 2½" - green (4) 1½" x 2½" - navy
E	(4) 1½" x 1½" - light blue (4) 1½" x 1½" - navy
F	(4) 1½" x 2"
G	 (2) 2" x 2" - light blue, cut once diagonally (2) 2" x 2" - navy, cut once diagonally
H	(1) 2½" x 3½"

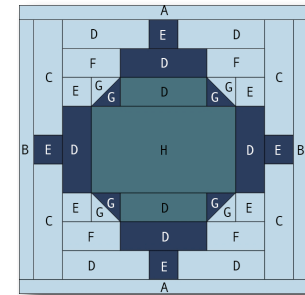

Hobbystash Colorway

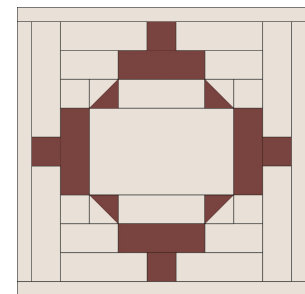

Jane Stickle Colorway

**The actual required width for Unit A and Unit B units is ¾". The increased width specified above allows for squaring the block to exactly 5½".*

Assembly:

1. Using the templates provided on Page C10-2, foundation piece each section.
2. Joint the sections together.
3. Join Unit B to the right side of the block, and then the left.
4. Join Unit A to the top of the block and then the bottom. Square up block to measure 5½" x 5½"

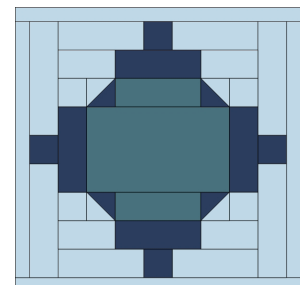
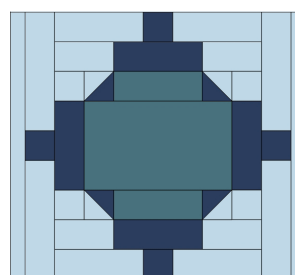
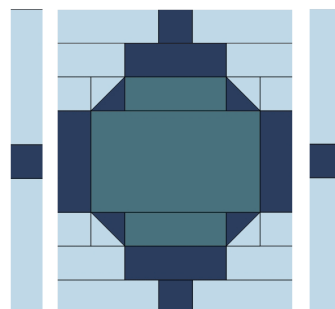
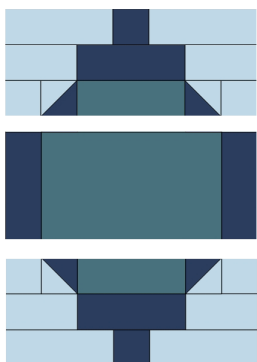

SET PRINTER TO "ACTUAL SIZE" WHEN PRINTING THIS PAGE.

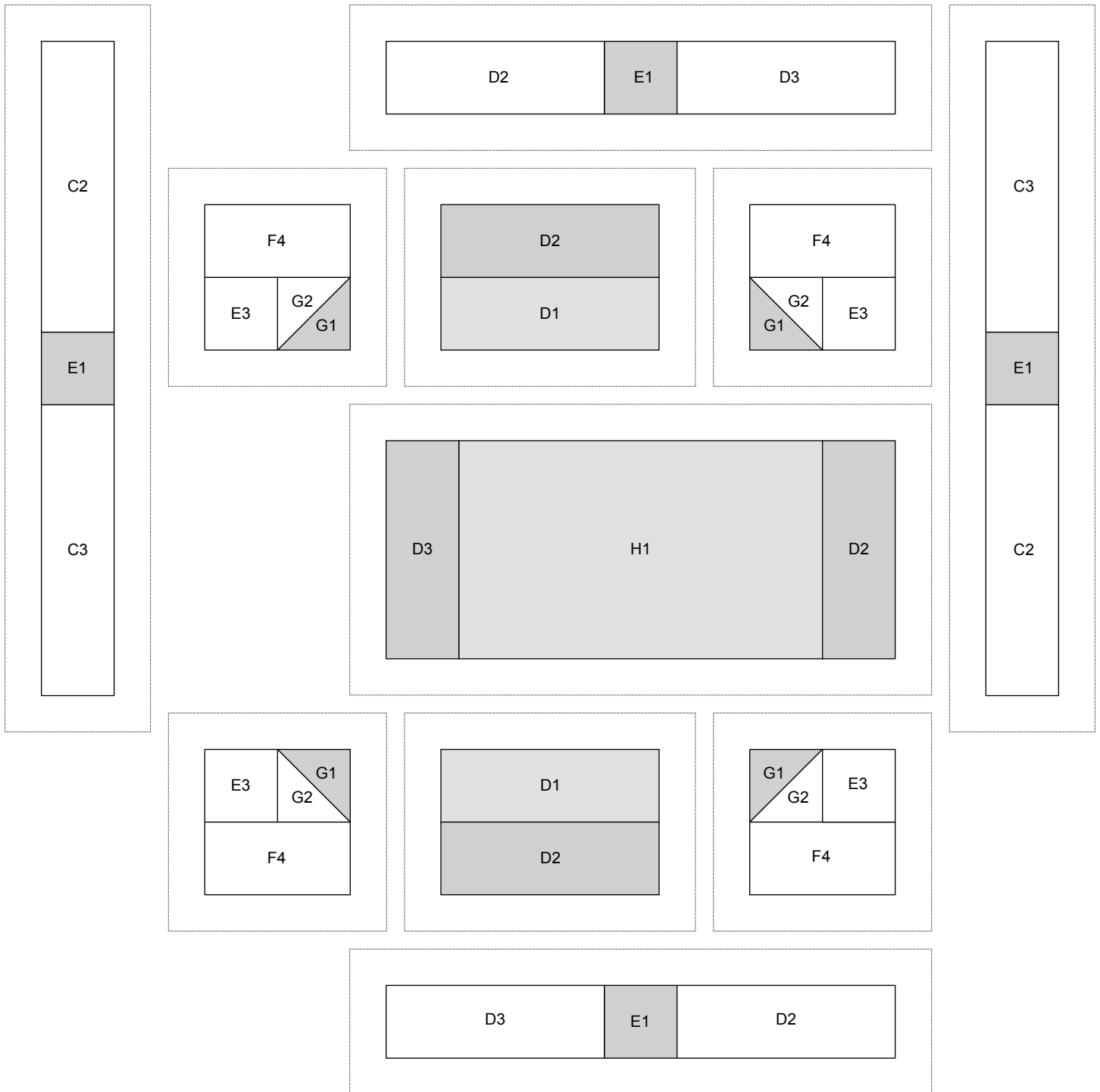

2"

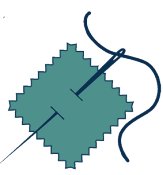

SET PRINTER TO "ACTUAL SIZE" WHEN PRINTING THIS PAGE.

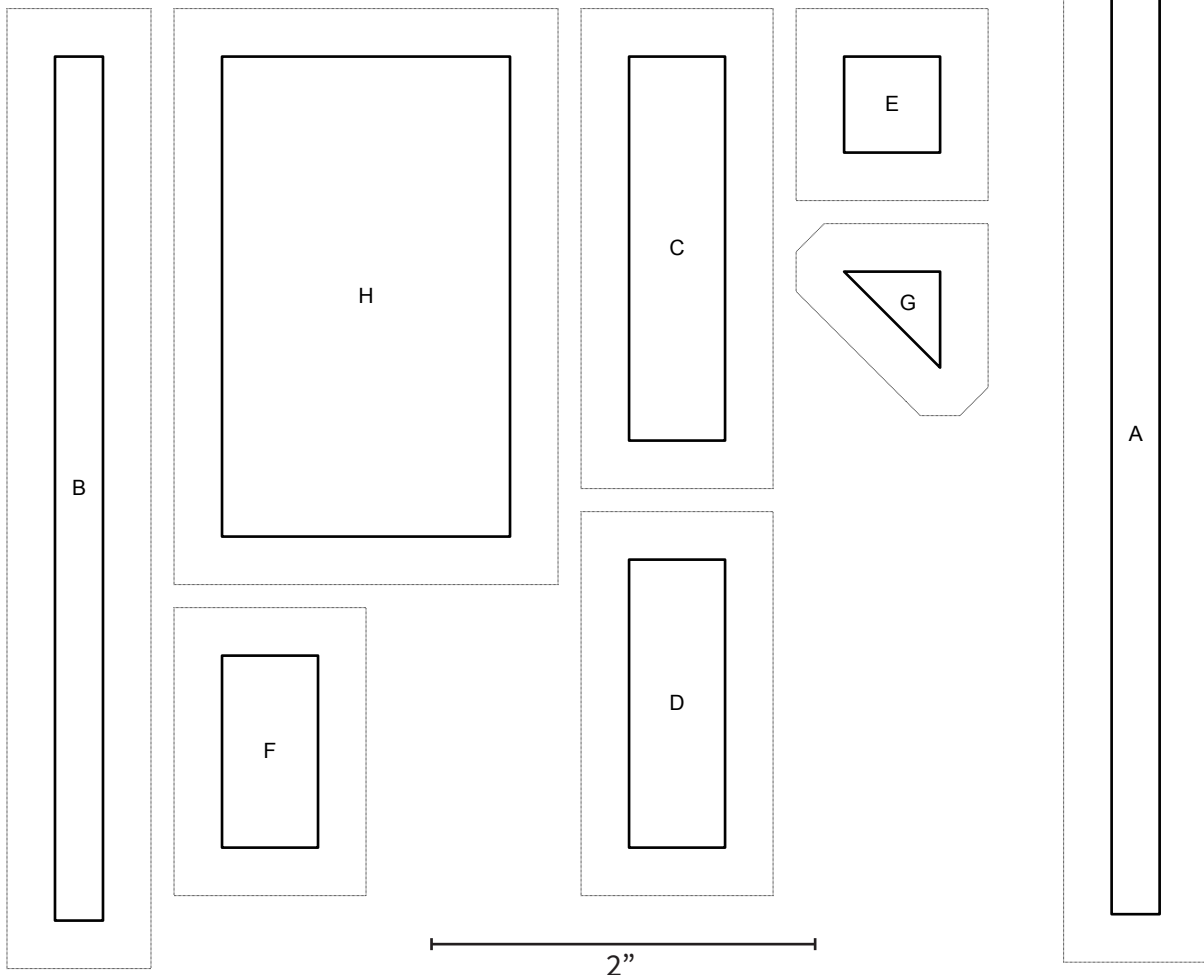
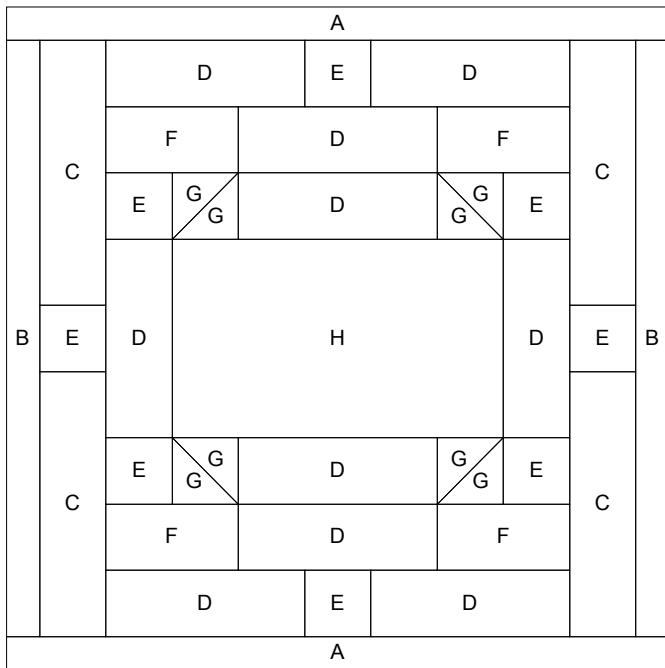

The Jane Stickle Quilt - Block C11

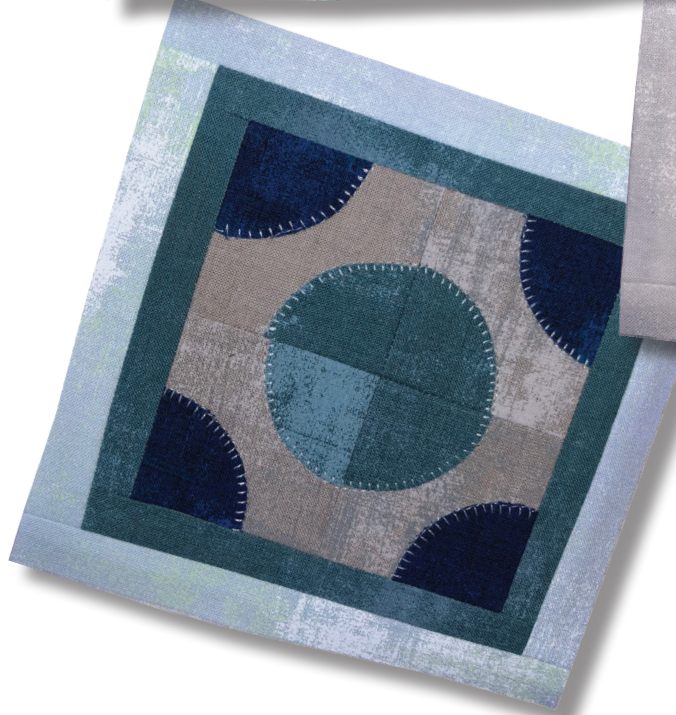

What you need:

Units	Quantity/size
A*	(2) 1" x 6"
B*	(2) 1" x 5"
C	(2) 7/8" x 5"
D	(2) 7/8" x 4¼"
E	(4) 2¾" x 2¾"
F	(4) 2" x 2" - navy (4) 2" x 2" - green

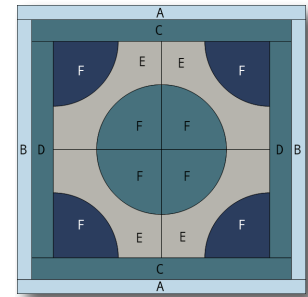

Hobbystash Colorway

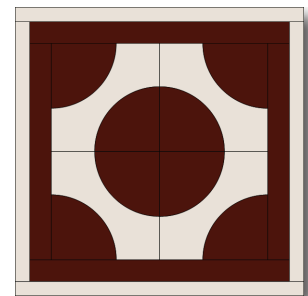

Jane Stickle Colorway

**The actual required width for Unit A and Unit B units is ¾". The increased specified width allows for squaring the block to exactly 5½".*

Assembly:

- Using template provided on Page C11-2, appliqué one navy Unit F and one green Unit F to Unit E as shown. Make four total. Joint the four appliquéd units together as shown.
- Join Unit D to the right side of the block, and then the left.
- Joint Unit C to the top of the block and then the bottom.
- Join Unit B to the right side of the block, and then the left.
- Join Unit A to the top of the block and then the bottom. Square up block to measure 5½" x 5½"

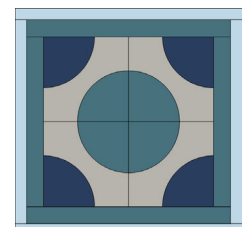
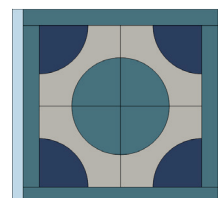
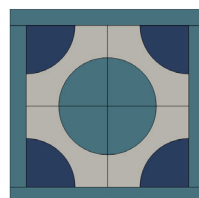
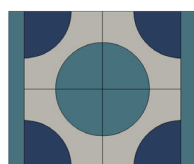
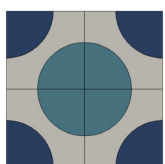

SET PRINTER TO "ACTUAL SIZE" WHEN PRINTING THIS PAGE.

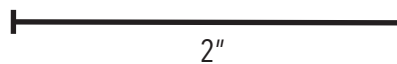
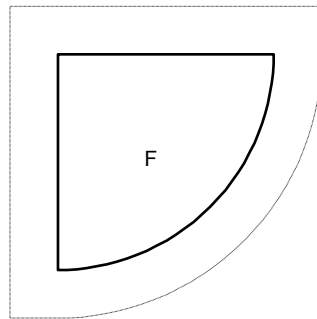

SET PRINTER TO "ACTUAL SIZE" WHEN PRINTING THIS PAGE.

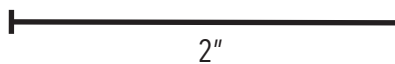
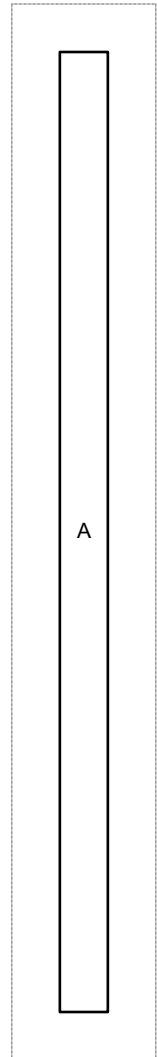
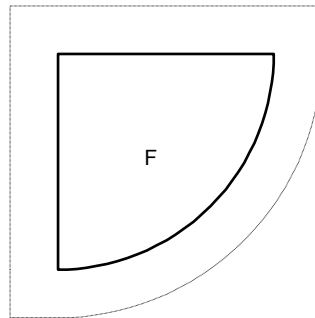
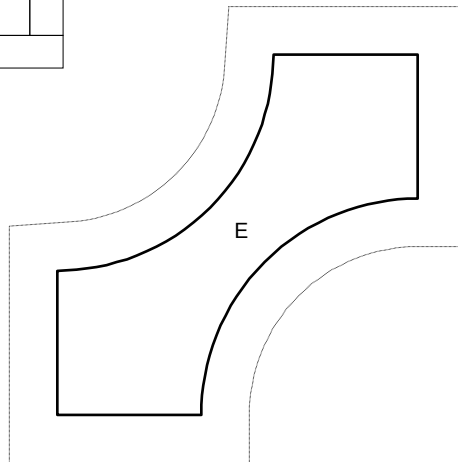
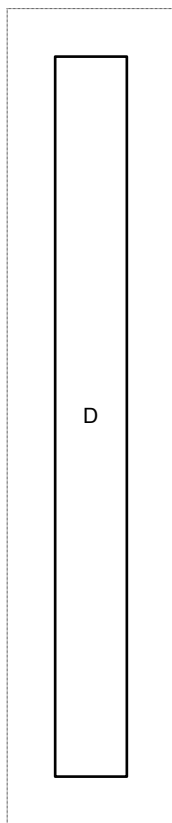
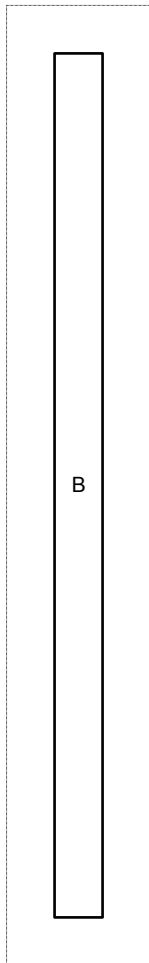
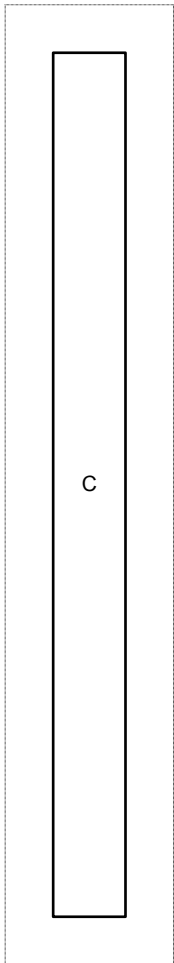
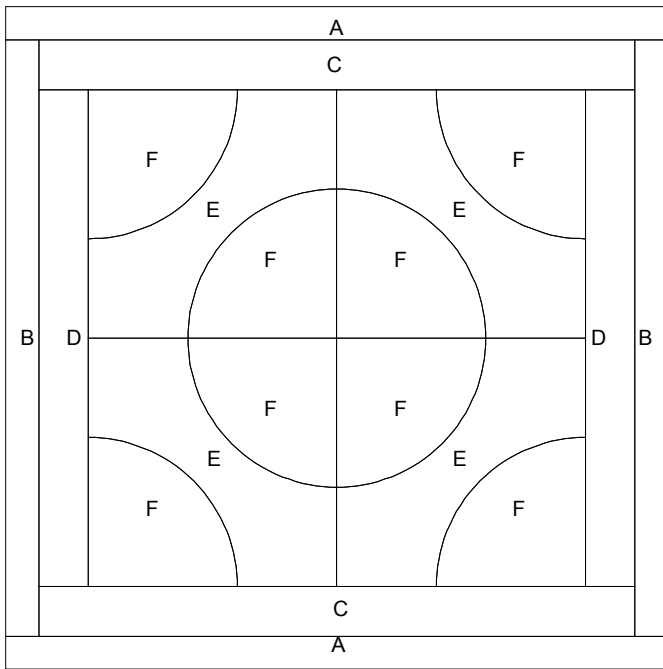

The Jane Stickle Quilt - Block C12

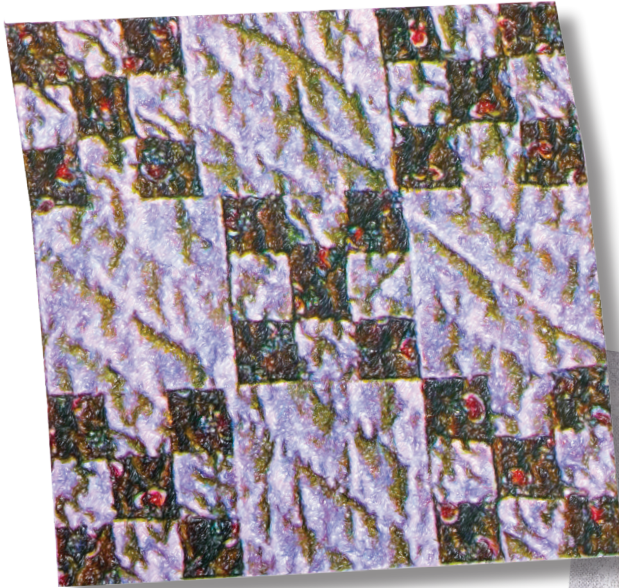

What you need:

Patches	Quantity/size
A*	(2) 1" x 6"
B*	(2) 1" x 5"
C	(17) 1" x 1" - green (8) 1" x 1" - navy (20) 1" x 1" - light blue
D	(2) 2" x 2" - gray (2) 2" x 2" - beige

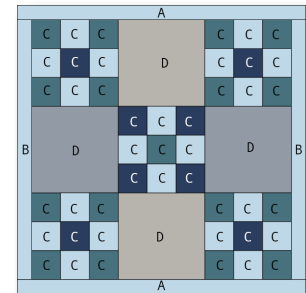

Hobbystash Colorway

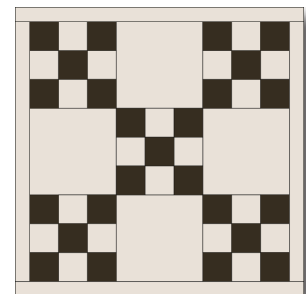

Jane Stickle Colorway

**The actual required width for Unit A and Unit B units is ¾". The increased width specified above allows for squaring the block to exactly 5½".*

Assembly:

1. Arrange four light blue Unit C, one navy Unit C, and four green Unit C as shown and sew together. Make four.
2. Arrange four light blue Unit C, one green Unit C, and four navy Unit C as shown and sew together.
3. Arrange two units from Step 1 and one beige Unit D as shown and sew together. Make two.
4. Arrange unit from Step 2 with two gray Unit D as shown and sew together.
5. Arrange units from Step 3 and Step 4 as shown and sew together.
6. Join Unit B to the right side of the block, and then the left.
7. Join Unit A to the top of the block and then the bottom. Square up block to measure 5½" x 5½"

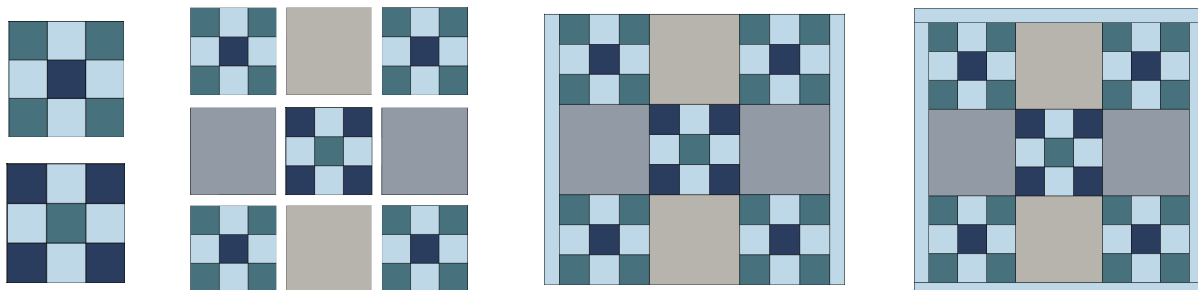

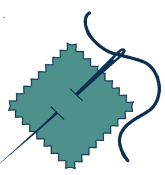

SET PRINTER TO "ACTUAL SIZE" WHEN PRINTING THIS PAGE.

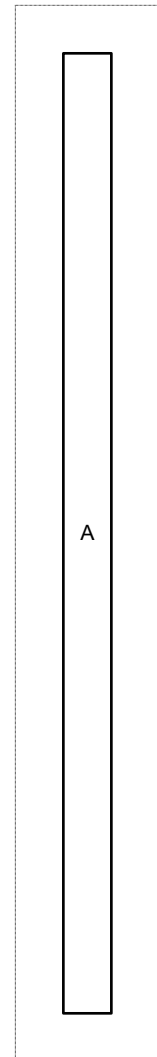
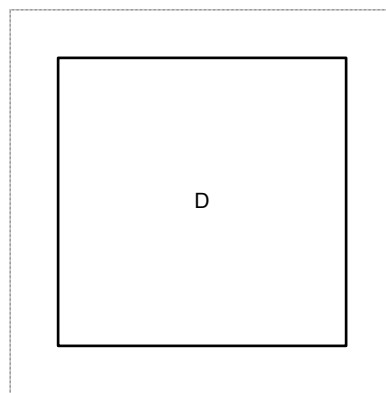
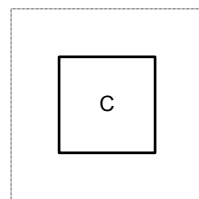
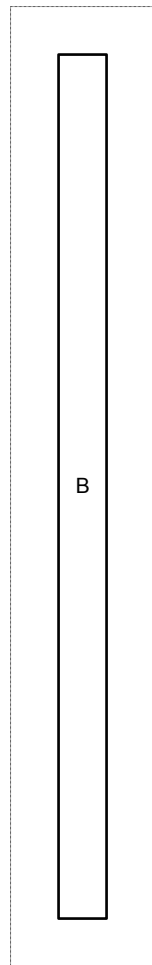
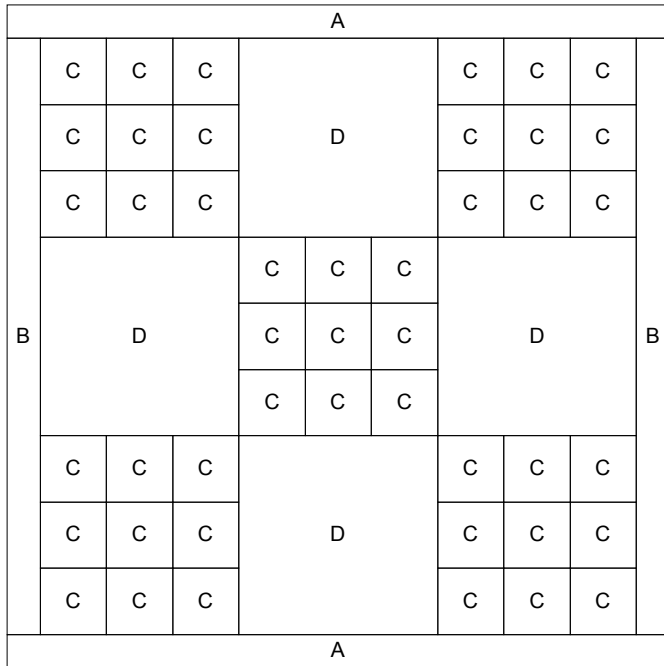

The Jane Stickle Quilt - Block C13

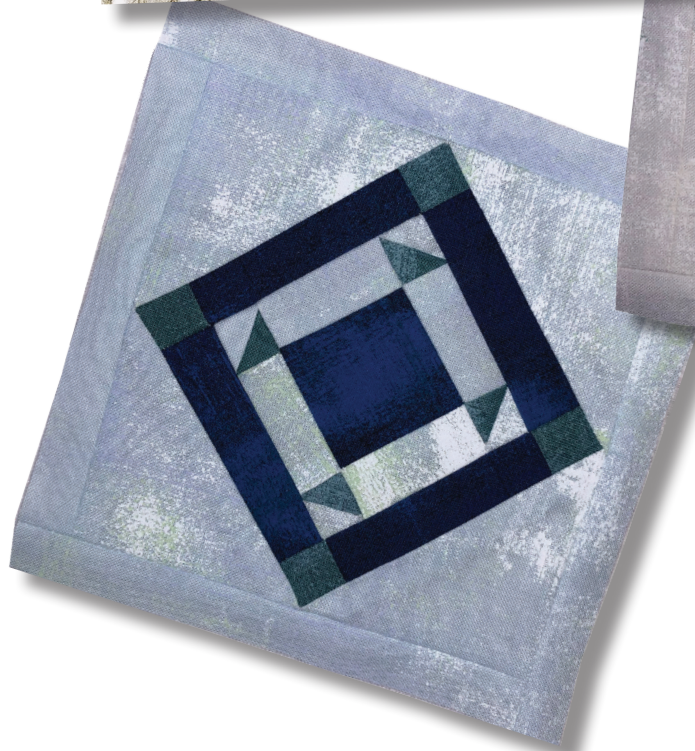
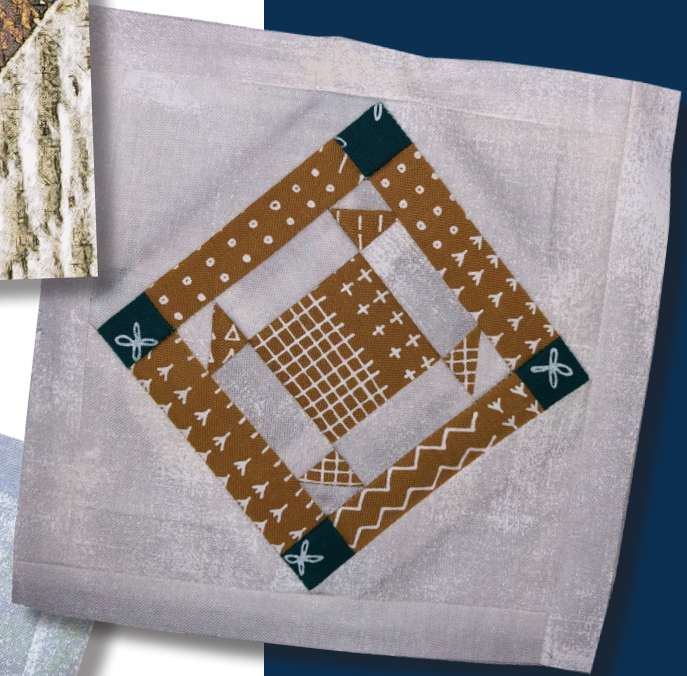

What you need:

Patches	Quantity/size
A*	(2) 1" x 6"
B*	(2) 1" x 5"
C	(2) 3½" x 3½", cut once diagonally
D	(4) 1½" x 1½"
E	(4) 1½" x 3"
F	(1) 2½" x 2½" - green, cut twice diagonally (1) 2½" x 2½" - light blue, cut twice diagonally
G	(4) 1½" x 2"
H	(1) 2" x 2"

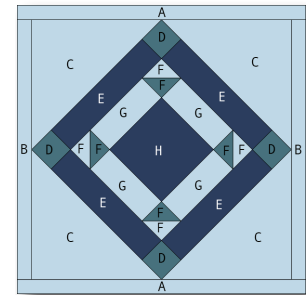

Hobbystash Colorway

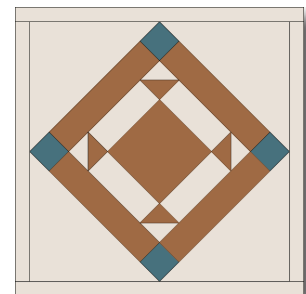

Jane Stickle Colorway

**The actual required width for Unit A and Unit B units is ¾". The increased width specified above allows for squaring the block to exactly 5½".*

Assembly:

1. Using the templates provided on Page C13-2, foundation piece each section.
2. Joint the sections together.
3. Join Unit B to the right side of the block, and then the left.
4. Join Unit A to the top of the block and then the bottom. Square up block to measure 5½" x 5½"

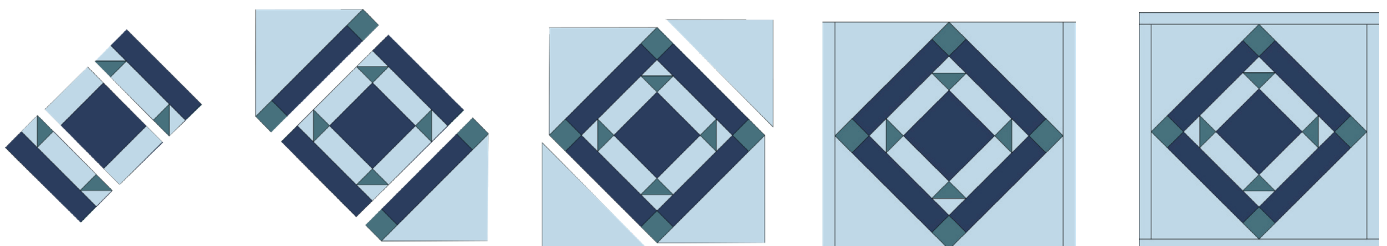

SET PRINTER TO "ACTUAL SIZE" WHEN PRINTING THIS PAGE.

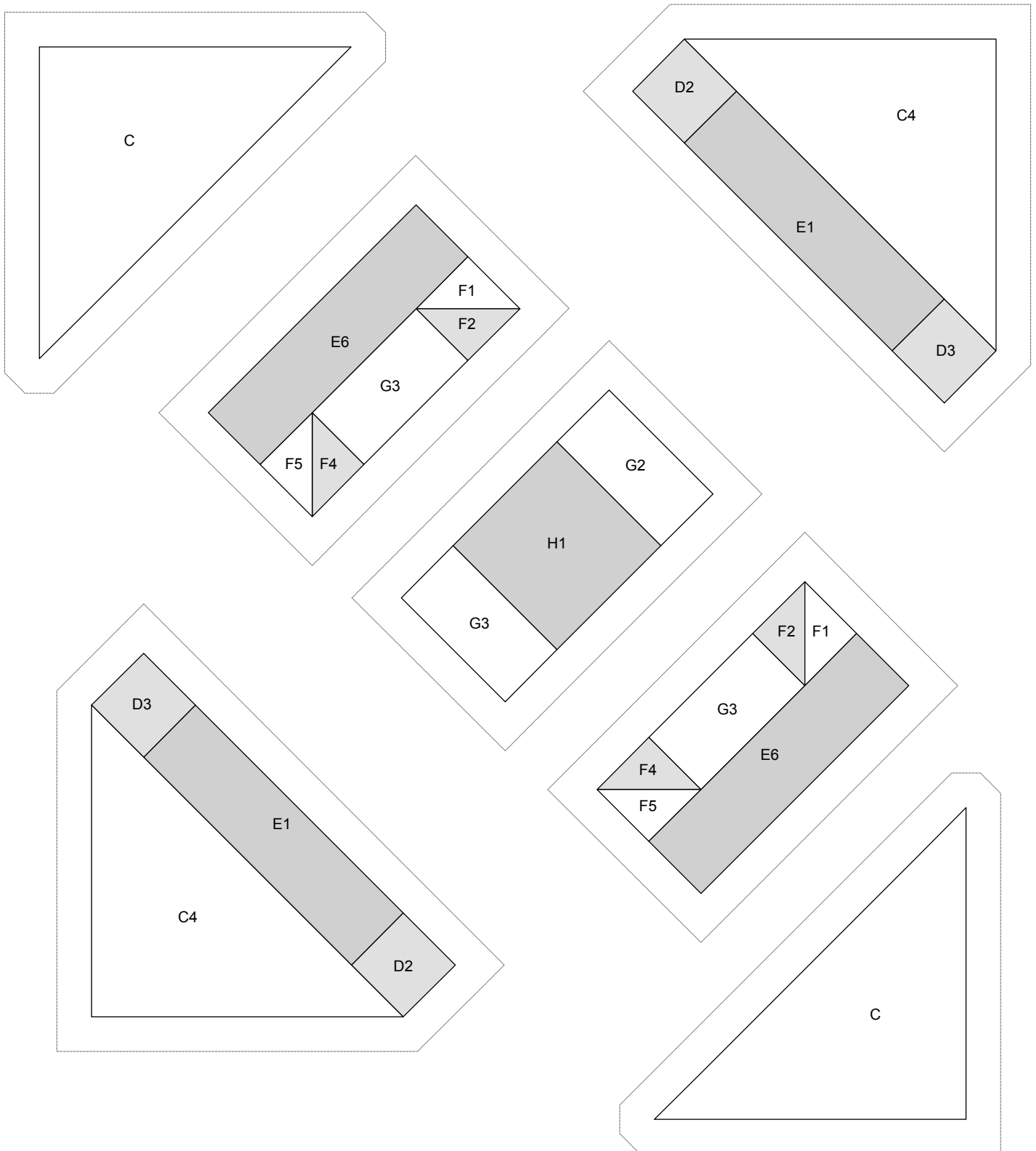

2"

SET PRINTER TO "ACTUAL SIZE" WHEN PRINTING THIS PAGE.

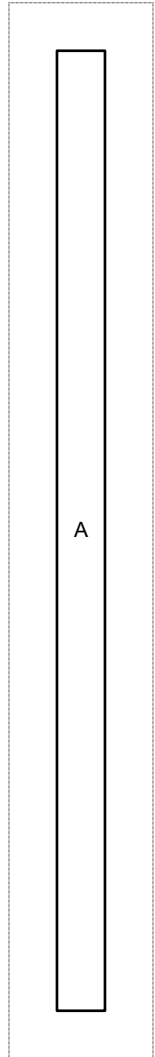
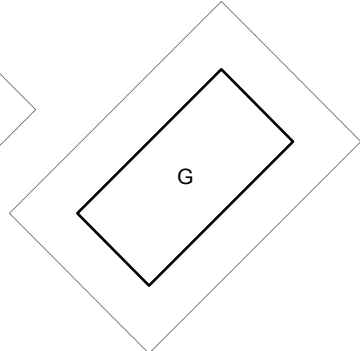
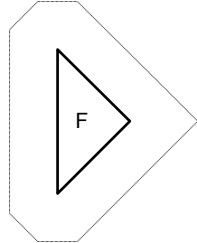
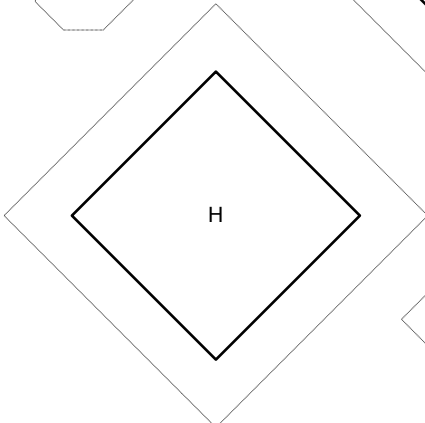
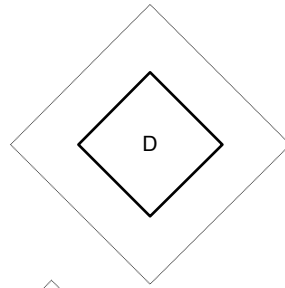
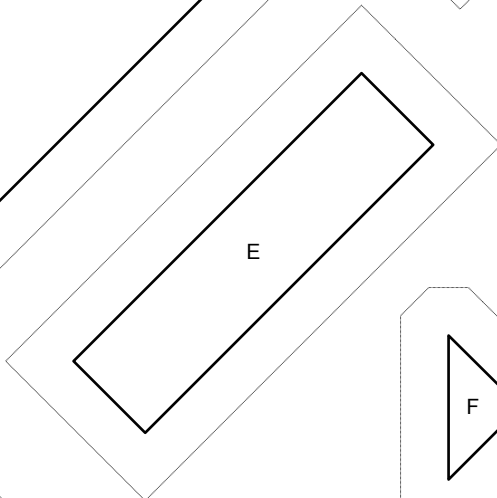
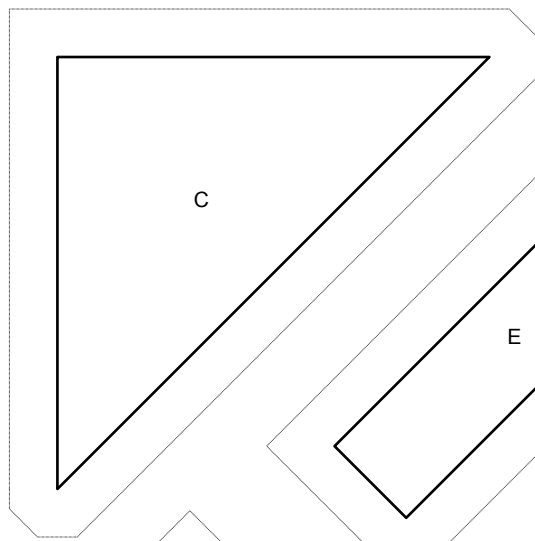
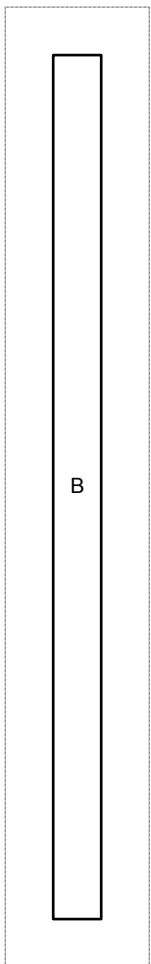
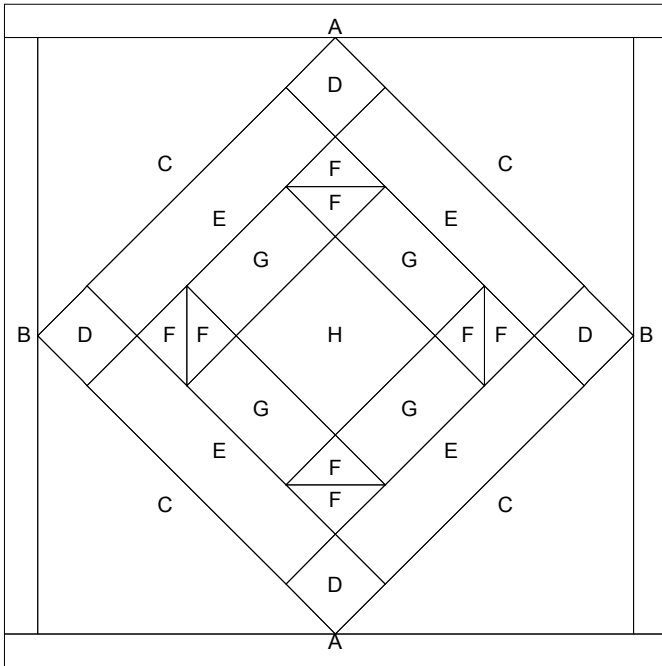

2"