

## The Jane Stickle Quilt - Row B

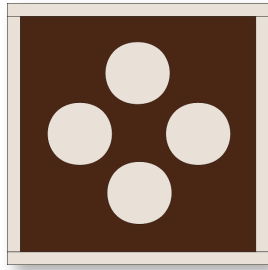

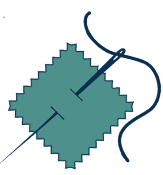

B1

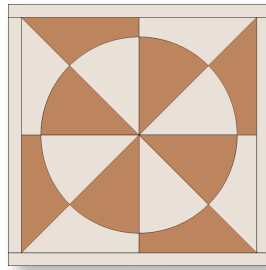

B2

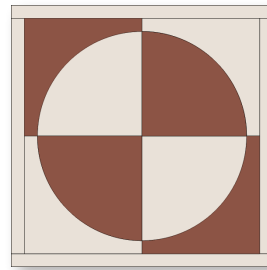

B3

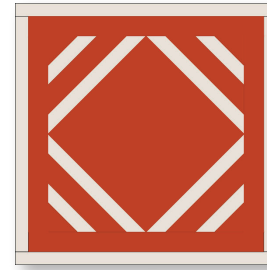

B4

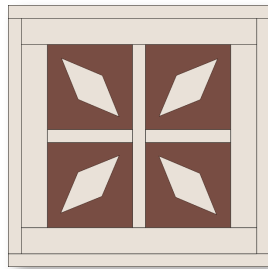

B5

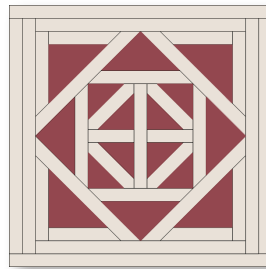

B6

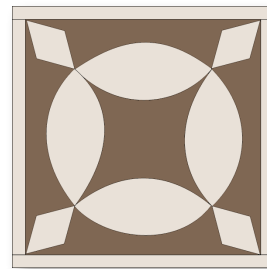

B7

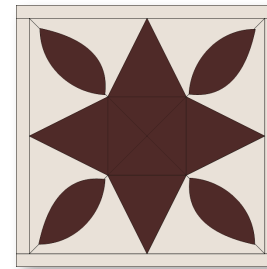

B8

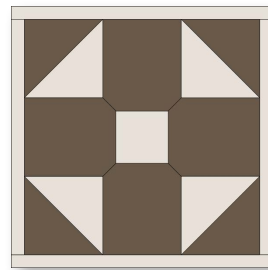

B9

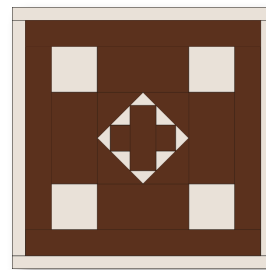

B10

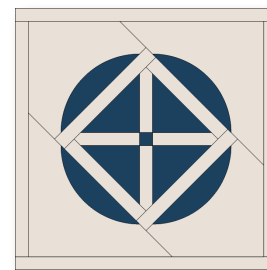

B11

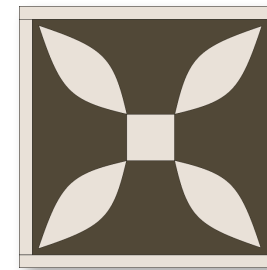

B12

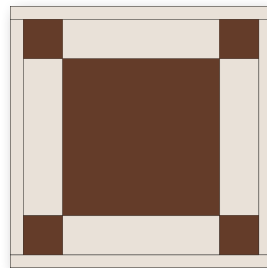

B13



## The Jane Stickle Quilt - Block B1

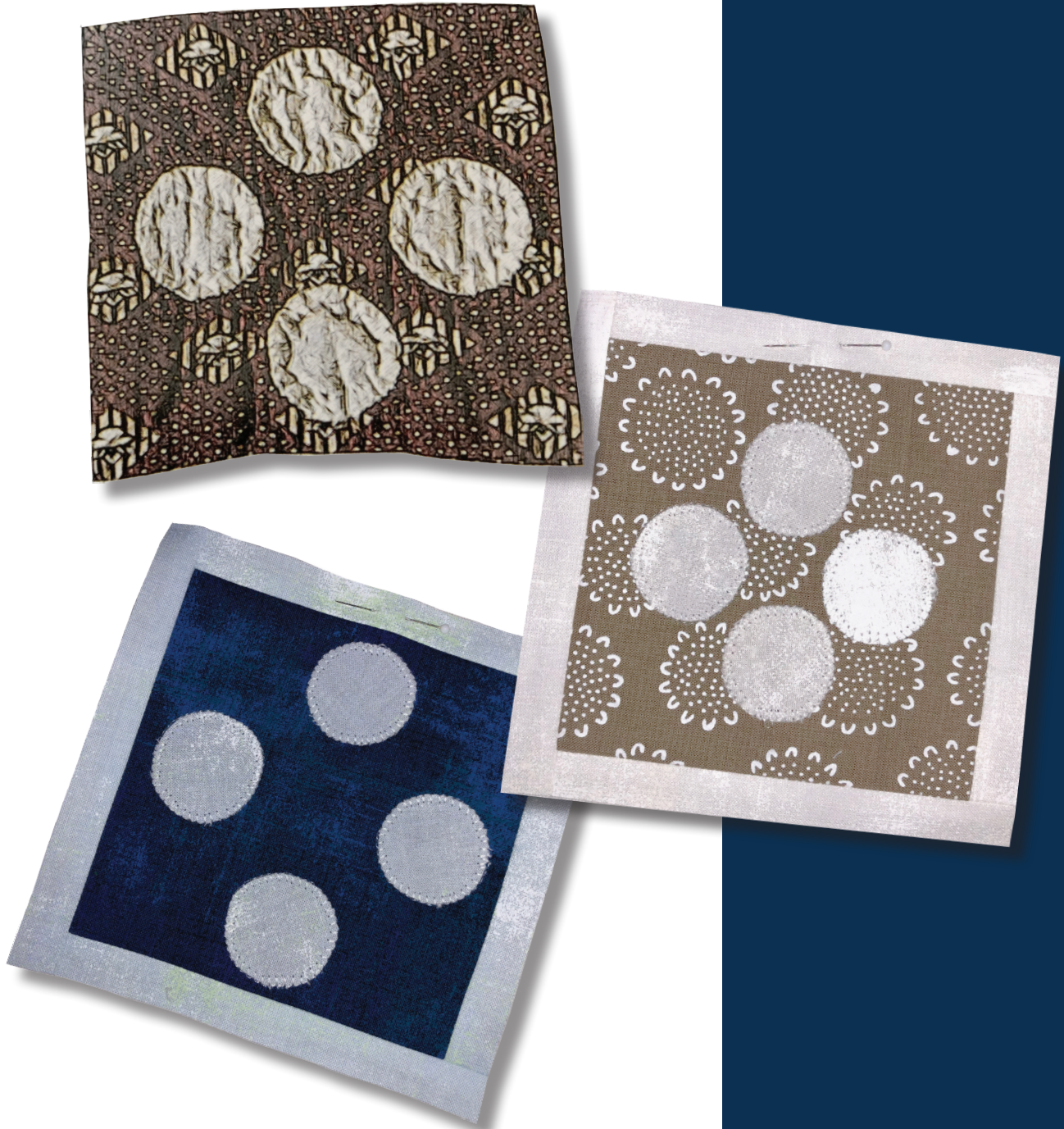

### What you need:

Patches	Quantity/size
A*	(2) 1" x 6"
B*	(2) 1" x 5"
C	(1) 6" x 6"
D	(4) 2" x 2"

*\*The actual required width for Unit A and Unit B units is ¾". The increased width specified above allows for squaring the block to exactly 5½".*

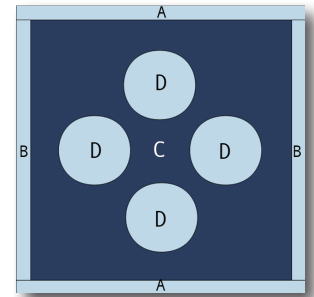

*Hobbystash Colorway*

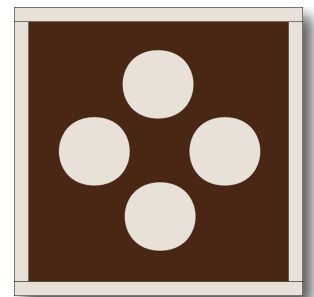

*Jane Stickle Colorway*

### Assembly:

1. Using the templates provided on page B1-2 (appliqué) or B1-3 (hand piecing), appliqué the four circle units to Unit C of the block. When all the circles have been appliquéd to Unit C, trim the block to 5" x 5" square.
2. Join Unit B to the right side of the block, and then the left.
3. Join Unit A to the top of the block and then the bottom. Square up block to measure 5½" x 5½".

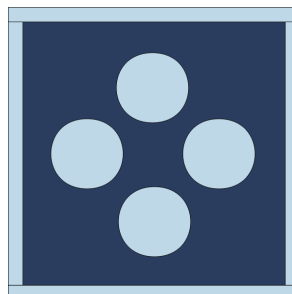

SET PRINTER TO "ACTUAL SIZE" WHEN PRINTING THIS PAGE.

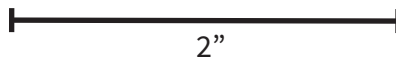
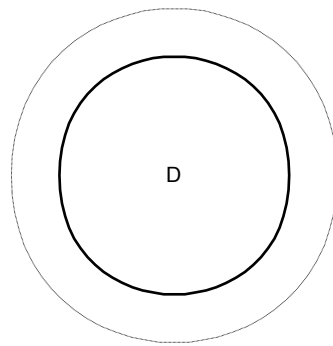

SET PRINTER TO "ACTUAL SIZE" WHEN PRINTING THIS PAGE.

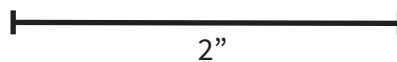
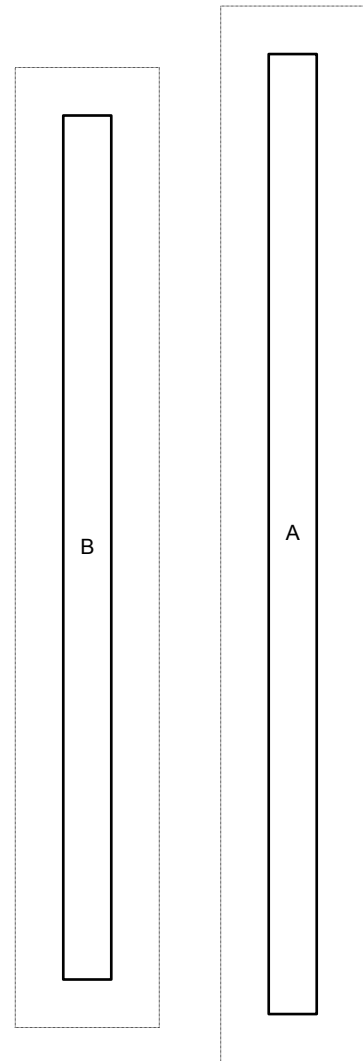
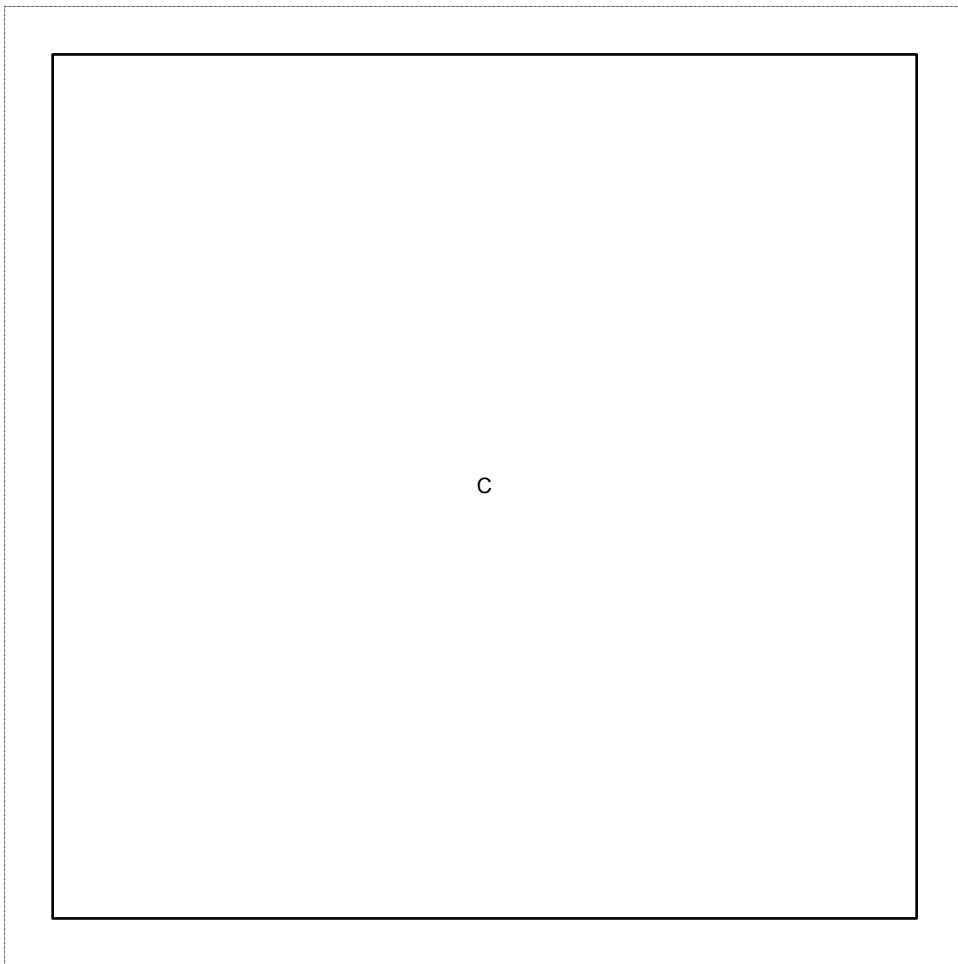
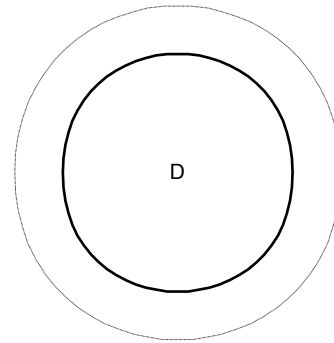
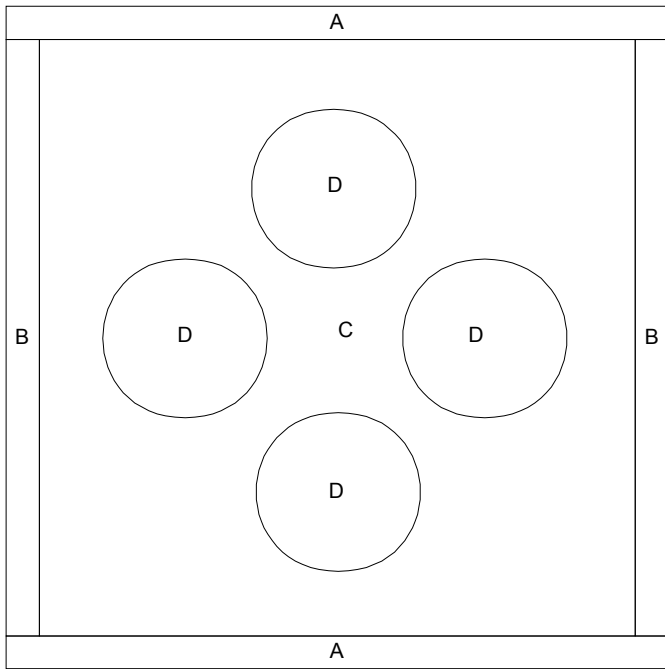



## The Jane Stickle Quilt - Block B2





### What you need:

Units	Quantity/size
A*	(2) 1" x 6"
B*	(2) 1" x 5"
C	2 squares 3½" x 3½"
D	2 squares 3½" x 3½"
E	2 squares 3½" x 3½"
F	2 squares 3½" x 3½"

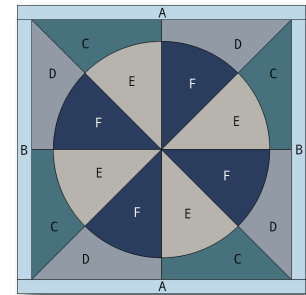

Hobbystash Colorway

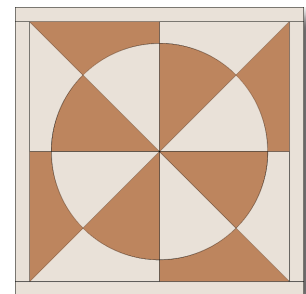

Jane Stickle Colorway

*\*The actual required width for Unit A and Unit B units is ¾". The increased width specified above allows for squaring the block to exactly 5½".*

### Assembly:

- Referring to BASIC INSTRUCTIONS for half-square triangles (HST) two at a time, use the gray Unit D and the green Unit C to make four HST units. Arrange the four HST units as illustrated and sew together.
- Repeat the process with the beige Unit E and navy Unit F patches to make four HST units. Arrange the four HST units and sew together.
- Using the circle template on Page B2-2, cut a circle from the Step 2 HST patch. Arrange the cut circle patch on top of the HST patch from step 1 and appliqué. Square block to 5" x 5".
- Join Unit B to the right side of the block, and then the left.
- Join Unit A to the top of the block and then the bottom. Square up block to measure 5½" x 5½"

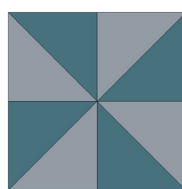

Step 1

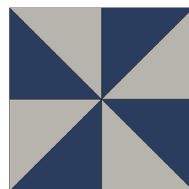

Step 2

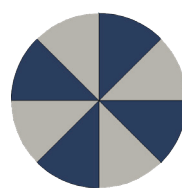

Step 3

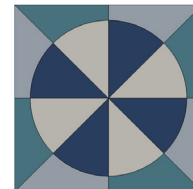

Step 3

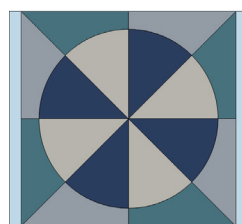

Step 4

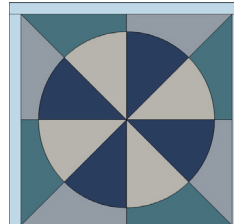

Step 5

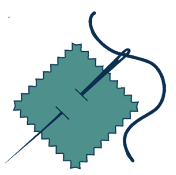

SET PRINTER TO "ACTUAL SIZE" WHEN PRINTING THIS PAGE.

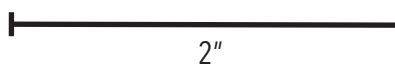
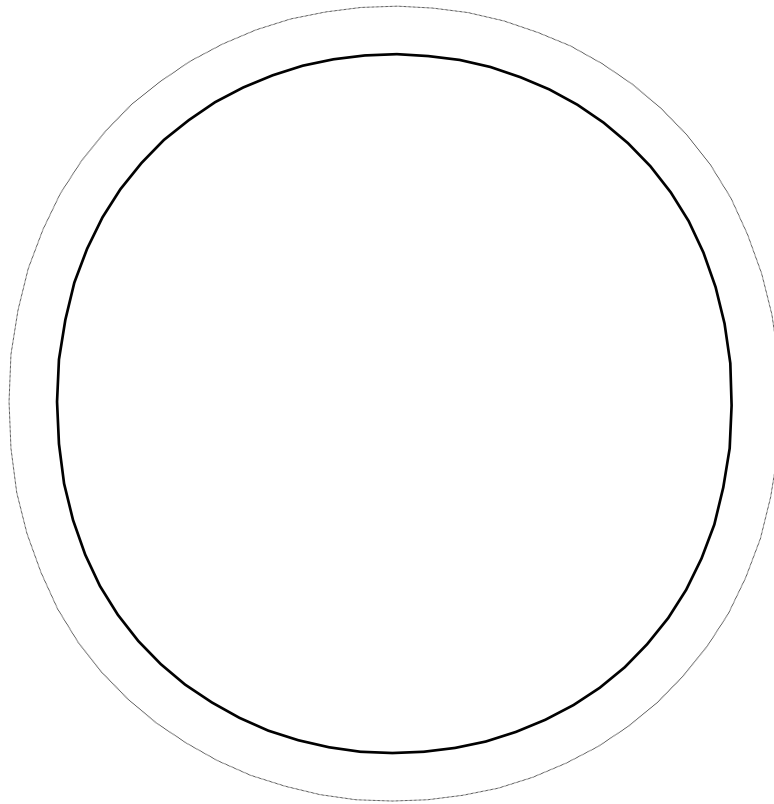

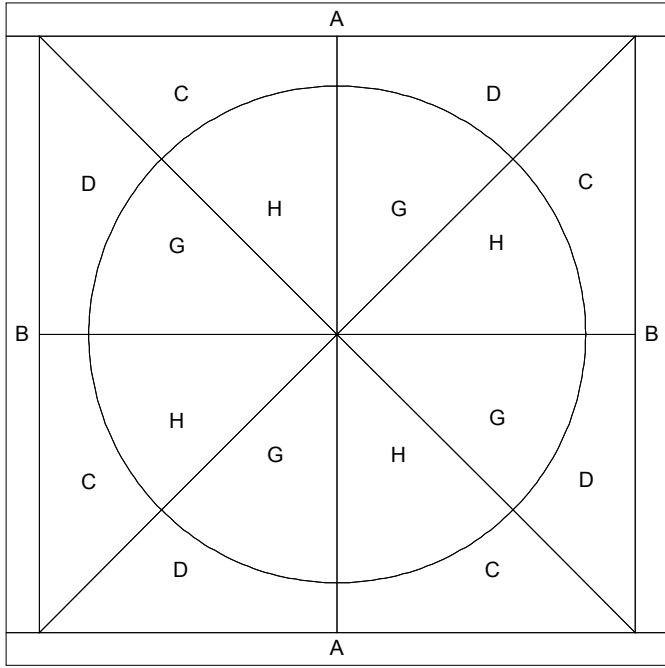

SET PRINTER TO "ACTUAL SIZE" WHEN PRINTING THIS PAGE.

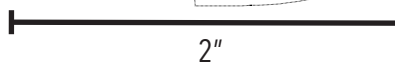
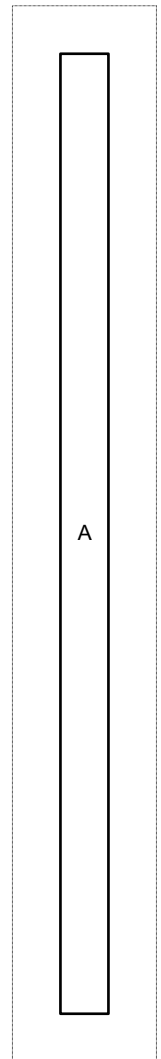
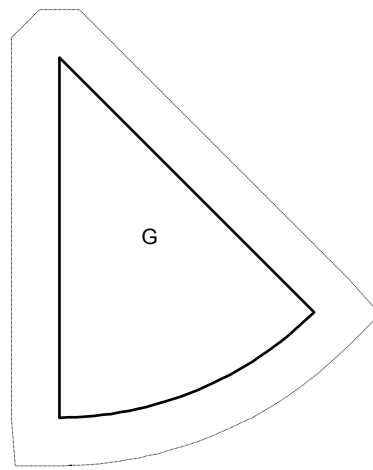
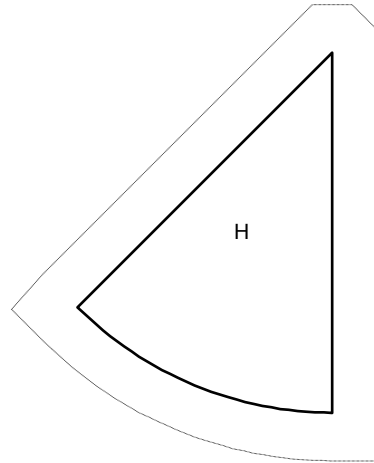
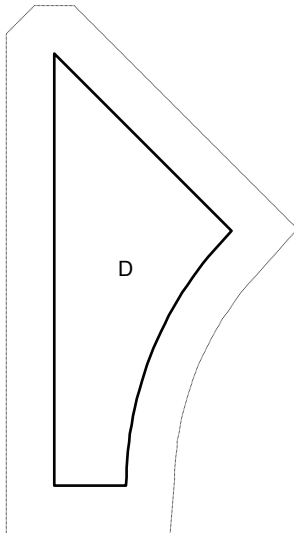
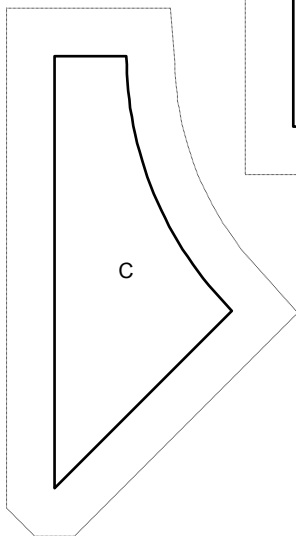
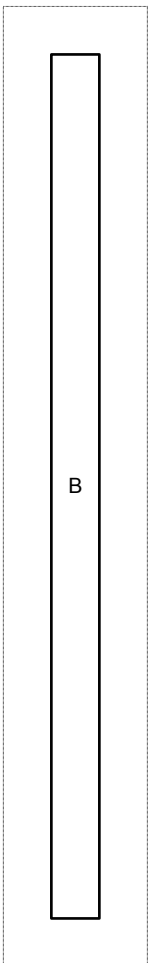

## The Jane Stickle Quilt - Block B3



### What you need:

Units	Quantity/size
A*	(2) 1" x 6"
B*	(2) 1" x 5"
C	2 squares 3½" x 3½" - navy 2 squares 3½" x 3½" - gray
D	2 squares 3½" x 3½" - beige 2 squares 3½" x 3½" - green

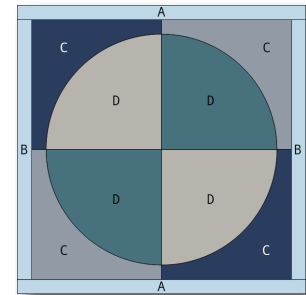

*Hobbystash Colorway*

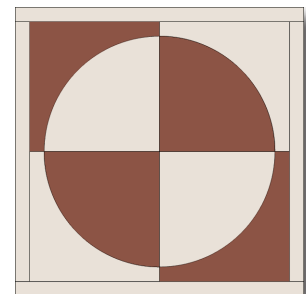

*Jane Stickle Colorway*

*\*The actual required width for Unit A and Unit B units is ¾". The increased width specified above allows for squaring the block to exactly 5½".*

### Assembly:

- Using the 2 navy Unit C and the 2 gray Unit C, assemble and sew together four patch unit.
- Repeat the process with the beige Unit D and green Unit D patches.
- Using the circle template on Page B3-2, cut a circle from the Step 2 four patch. Arrange the circle on top of the four-patch unit from Step 1 and appliqué the circle to the four patch. Square block to 5" x 5".
- Join Unit B to the right side of the block, and then the left.
- Join Unit A to the top of the block and then the bottom. Square up block to measure 5½" x 5½"

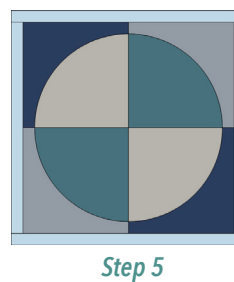
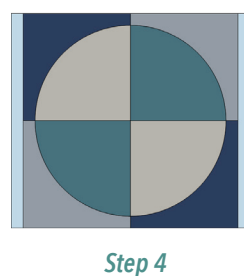
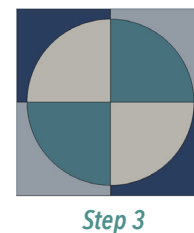
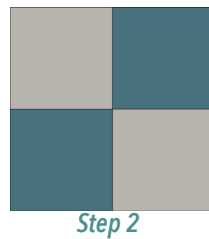
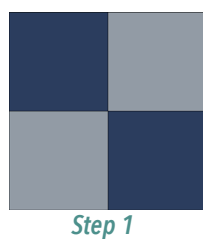



SET PRINTER TO "ACTUAL SIZE" WHEN PRINTING THIS PAGE.

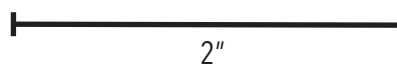
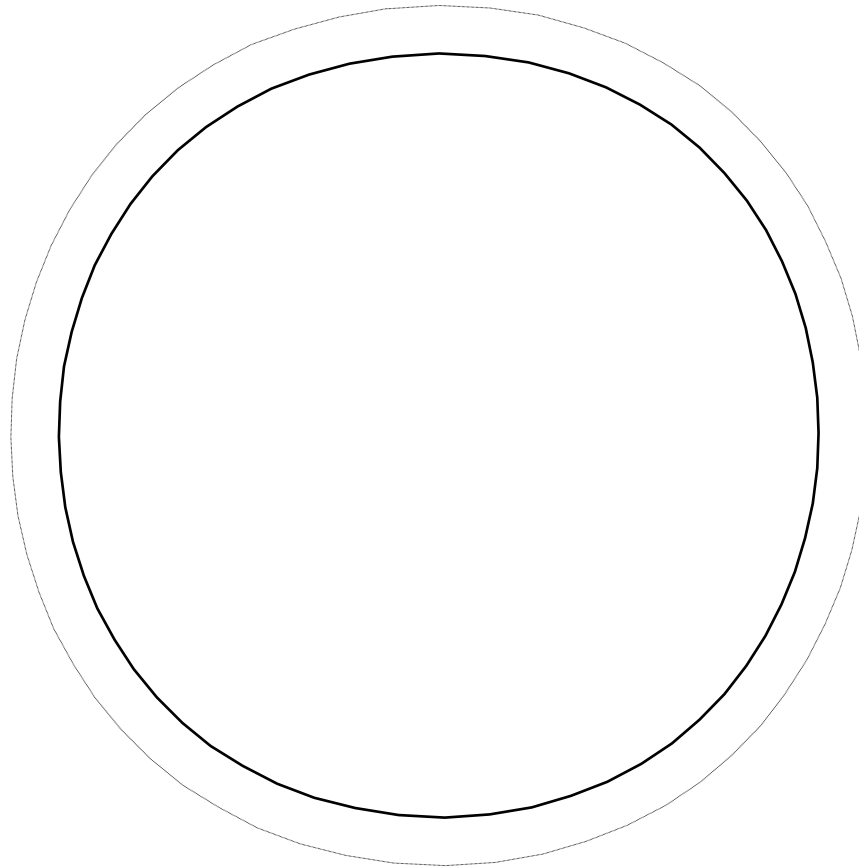

SET PRINTER TO "ACTUAL SIZE" WHEN PRINTING THIS PAGE.

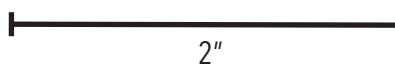
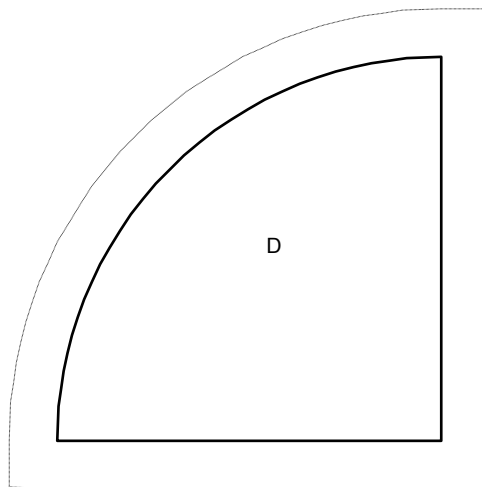
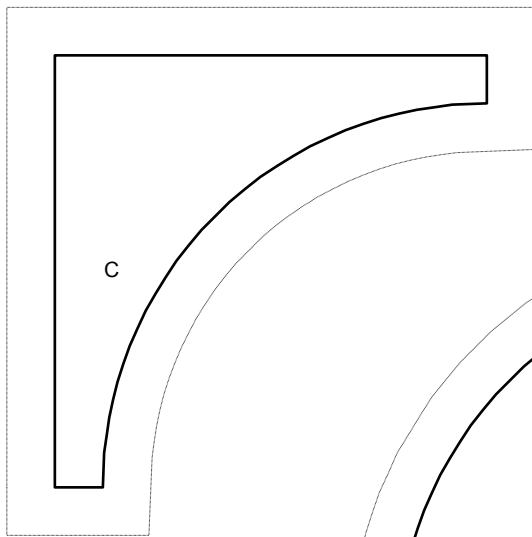
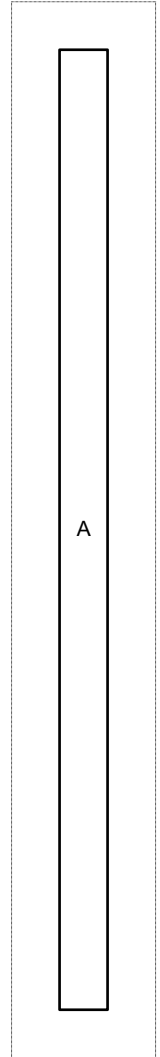
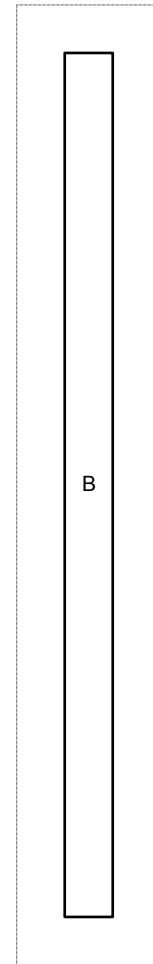
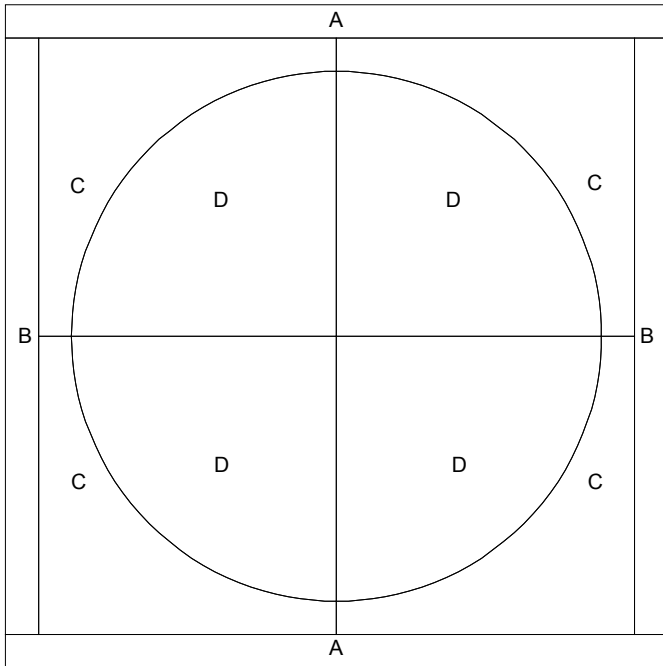

## The Jane Stickle Quilt - Block B4

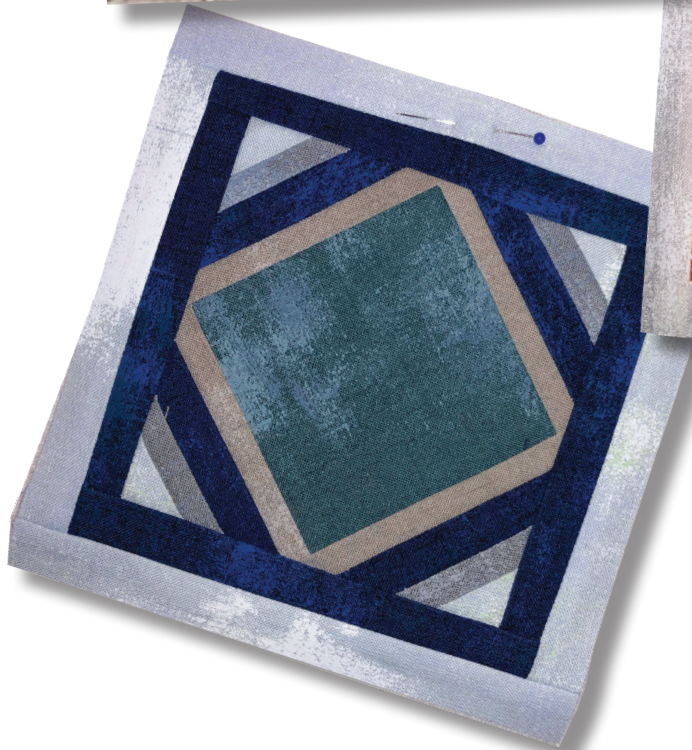
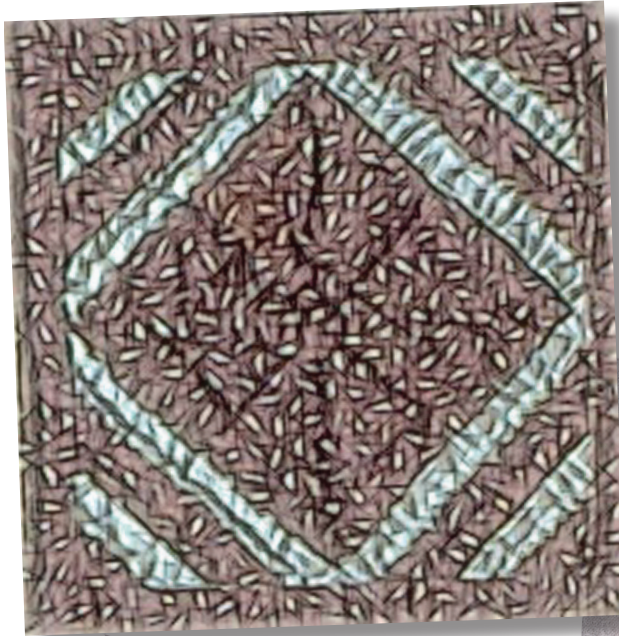

### What you need:

Units	Quantity/size
A*	(2) 1" x 6"
B*	(2) 1" x 5"
C	2 rectangles 1" x 5½"
D	2 rectangles 1" x 5"
E 	2 squares 2" x 2", cut once diagonally
F	4 rectangles 1" x 3"
G	4 rectangles 1" x 4"
H	4 rectangles 1" x 4"
I	1 square 3½" x 3½"

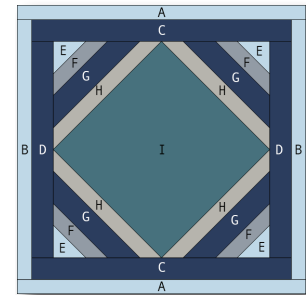

*Hobbystash Colorway*

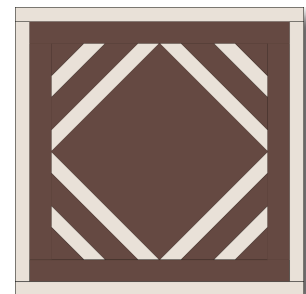

*Jane Stickle Colorway*

*\*The actual required width for Unit A and Unit B units is ¾". The increased width specified above allows for squaring the block to exactly 5½".*

### Assembly:

- Using the templates provided on Page B4-2, foundation piece the five sections.
- Join the sections together.
- Join Unit B to the right side of the block, and then the left.
- Join Unit A to the top of the block and then the bottom. Square up block to measure 5½" x 5½"



*Step 2*

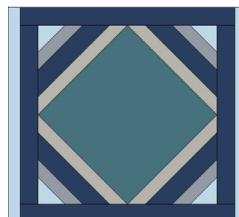

*Step 3*

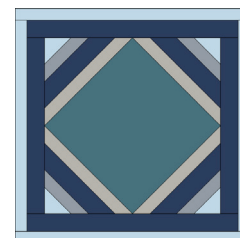

*Step 4*

SET PRINTER TO "ACTUAL SIZE" WHEN PRINTING THIS PAGE.

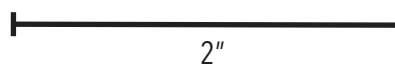
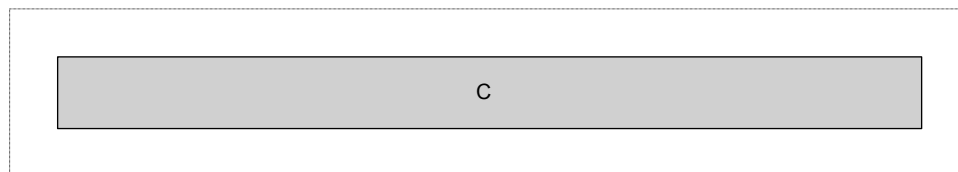
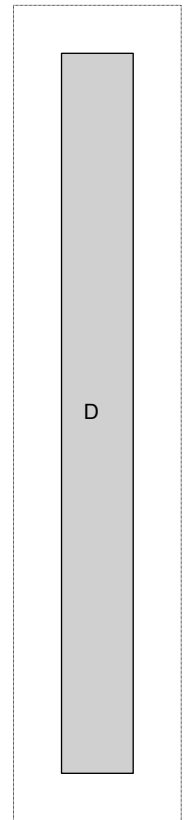
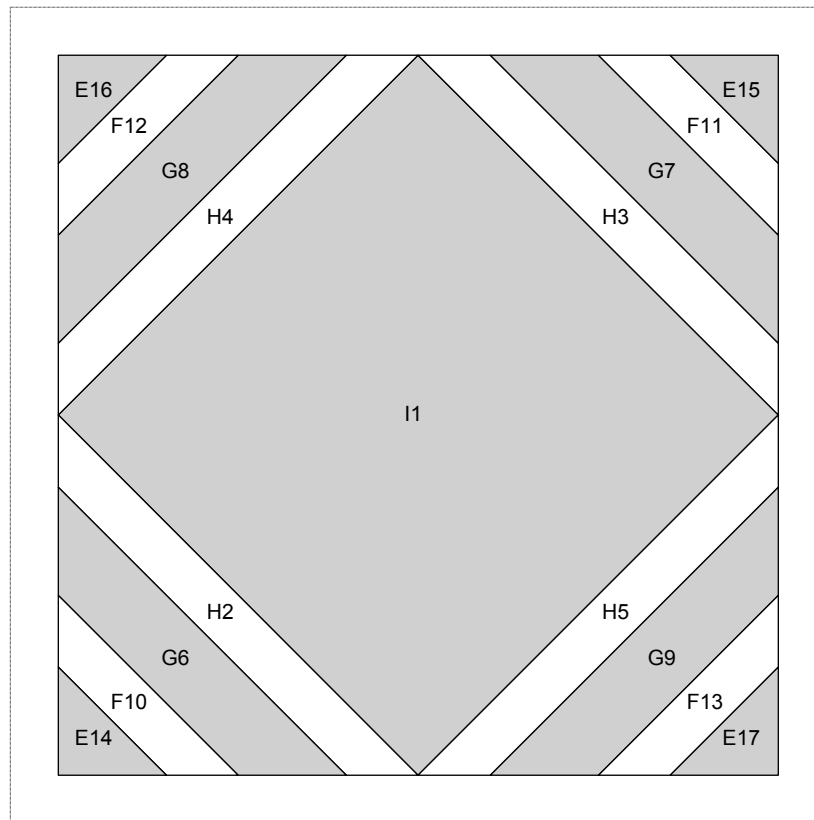
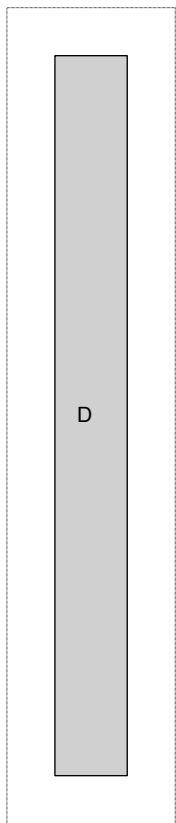
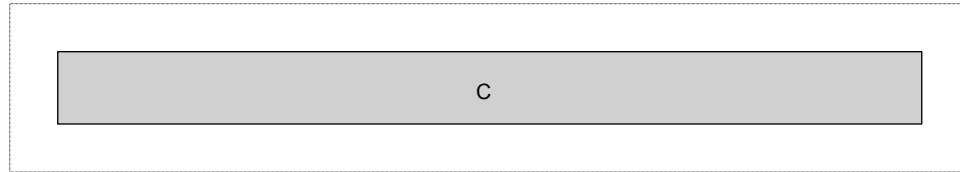



SET PRINTER TO "ACTUAL SIZE" WHEN PRINTING THIS PAGE.

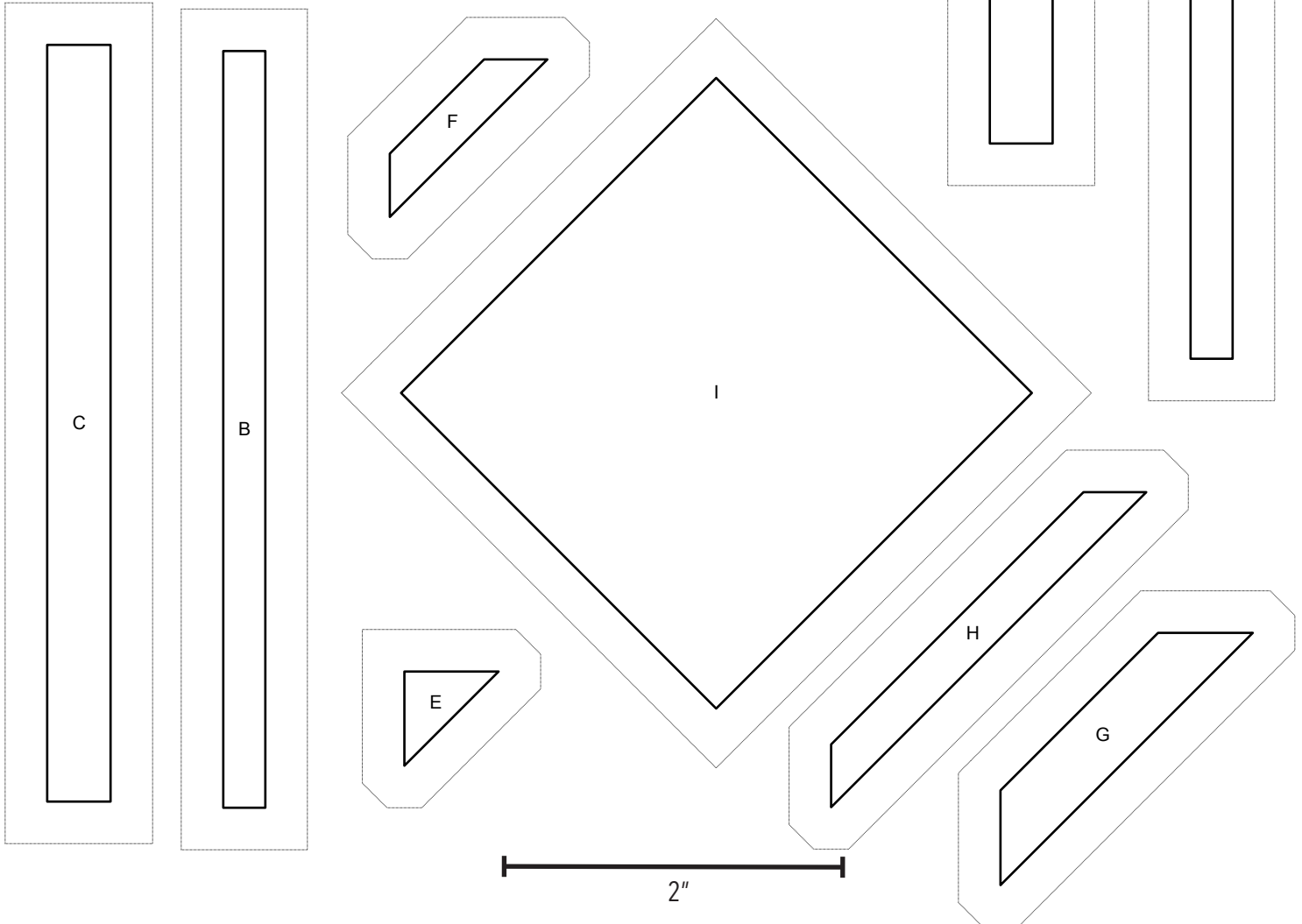
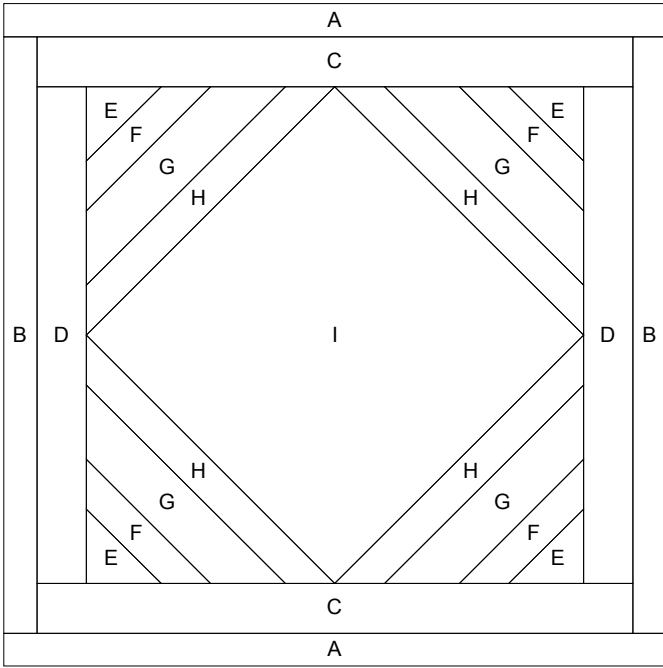

## The Jane Stickle Quilt - Block B5



### What you need:

Patches	Quantity/size
A*	(2) 1" x 6"
B*	(2) 1" x 5"
C	2 rectangles 1" x 5"
D	2 rectangles 1" x 4"
E	2 squares 2⅛" x 2⅛" - navy 2 squares 2⅛" x 2⅛" - green
F	1 rectangle ¾" x 4"
G	2 rectangles ¾" x 2⅛"
H	4 squares 1" x 2"

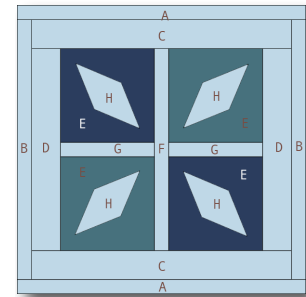

*Hobbystash Colorway*

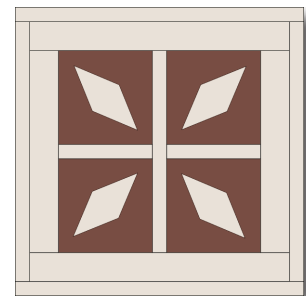

*Jane Stickle Colorway*

*\*The actual required width for Unit A and Unit B units is ¾". The increased width specified above allows for squaring the block to exactly 5½".*

### Assembly:

1. Arrange one Unit G between one navy Unit E and one green Unit E; sew together. Repeat for a second set.
2. Arrange Unit F between the two units created in Step 1 and sew together.
3. Sew Unit D to the left side of unit created in Step 2. Sew second Unit D to the right side.
4. Sew Unit C to the top of the unit created in Step 3. Sew the second Unit C to the bottom.
5. Using the templates provided on Page B5-2, appliqué Unit H diamonds to the block created in Step 5.
6. Join Unit B to the right side of the block, and then the left.
7. Join Unit A to the top of the block and then the bottom. Square up block to measure 5½" x 5½"



*Step 2*



*Step 3*

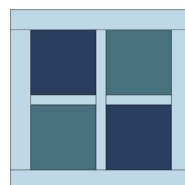

*Step 4*

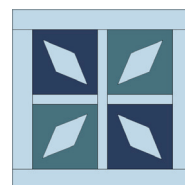

*Step 5*

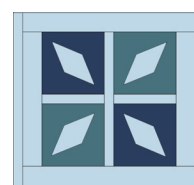

*Step 6*

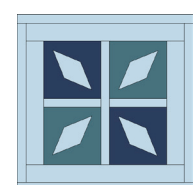

*Step 7*

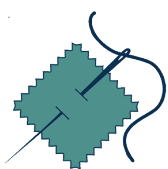

SET PRINTER TO "ACTUAL SIZE" WHEN PRINTING THIS PAGE.

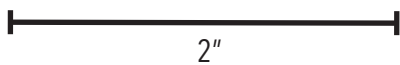
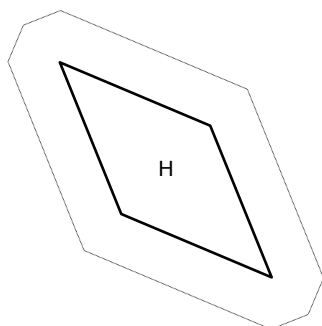

SET PRINTER TO "ACTUAL SIZE" WHEN PRINTING THIS PAGE.

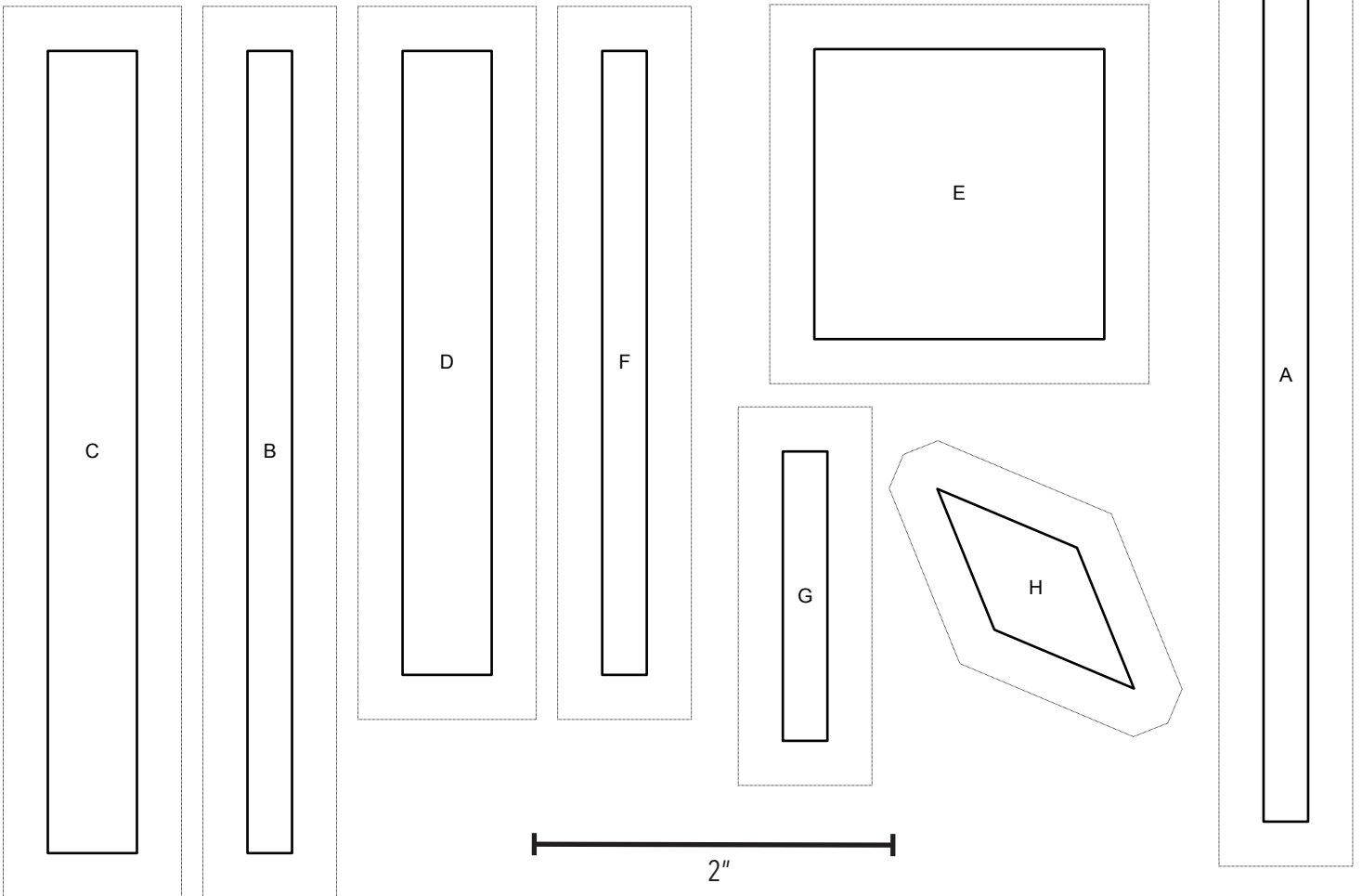
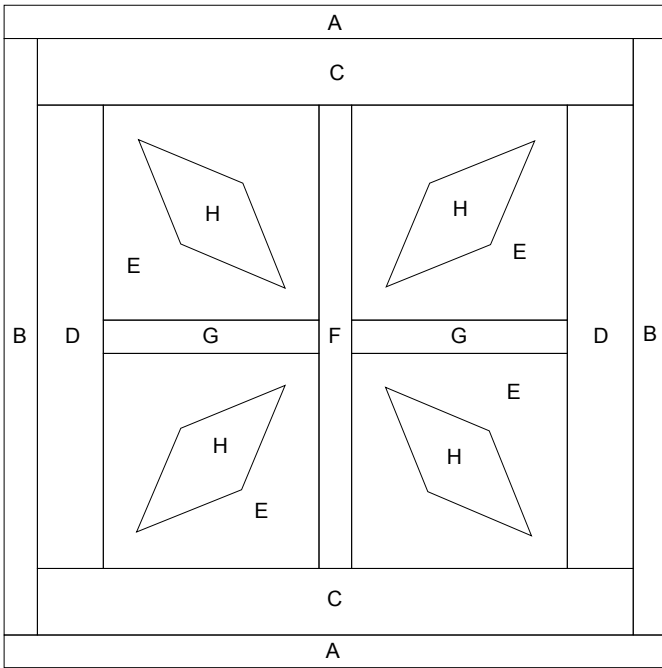



## The Jane Stickle Quilt - Block B6



### What you need:

Patches	Quantity/size
A*	(2) 1" x 6"
B*	(2) 1" x 5"
ba	(2) 1" x 5½"
C	(2) 1" x 5"
D	(4) 1" x 4½"
E, F	(4) 1" x 3"
G, H	(4) 1" x 3"
I	(2) 2½" x 2½", cut once diagonally
J	(2) 2" x 2", cut once diagonally - green (2) 2" x 2", cut once diagonally - navy
K, L, M, N	(4) 1" x 3"
O	{2} 1" x 2"
P	(1) 1" x 3½"
Q	(1) 3" x 3", cut twice diagonally
R	(4) 1" x 3½"

*\*The actual required width for Unit A and Unit B units is ¾". The increased width specified allows for squaring the block to exactly 5½".*

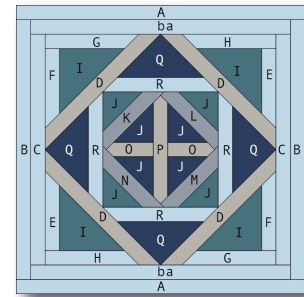

Hobbystash Colorway

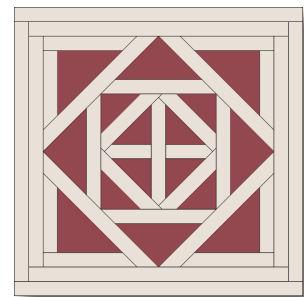

Jane Stickle Colorway

### Assembly:

- Using the templates provided on pages B6-2 and B6-3, foundation piece the sections of the block.
- Join the sections together.
- Join Unit B to the right side of the block, and then the left.
- Join Unit A to the top of the block and then the bottom. Square up block to measure 5½" x 5½".

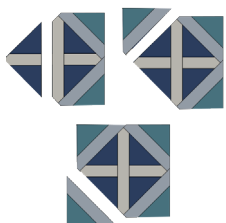

Step 2a

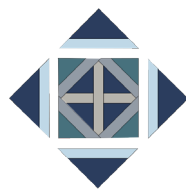

Step 2b

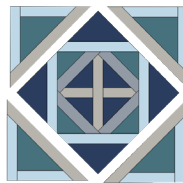

Step 2c

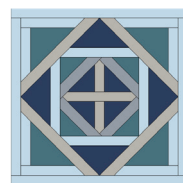

Step 2d

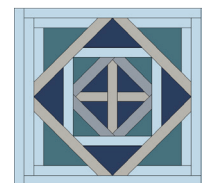

Step 3

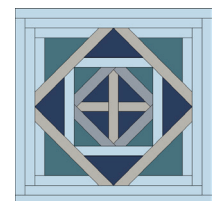

Step 4

SET PRINTER TO "ACTUAL SIZE" WHEN PRINTING THIS PAGE.

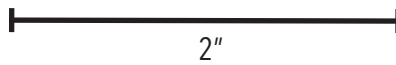
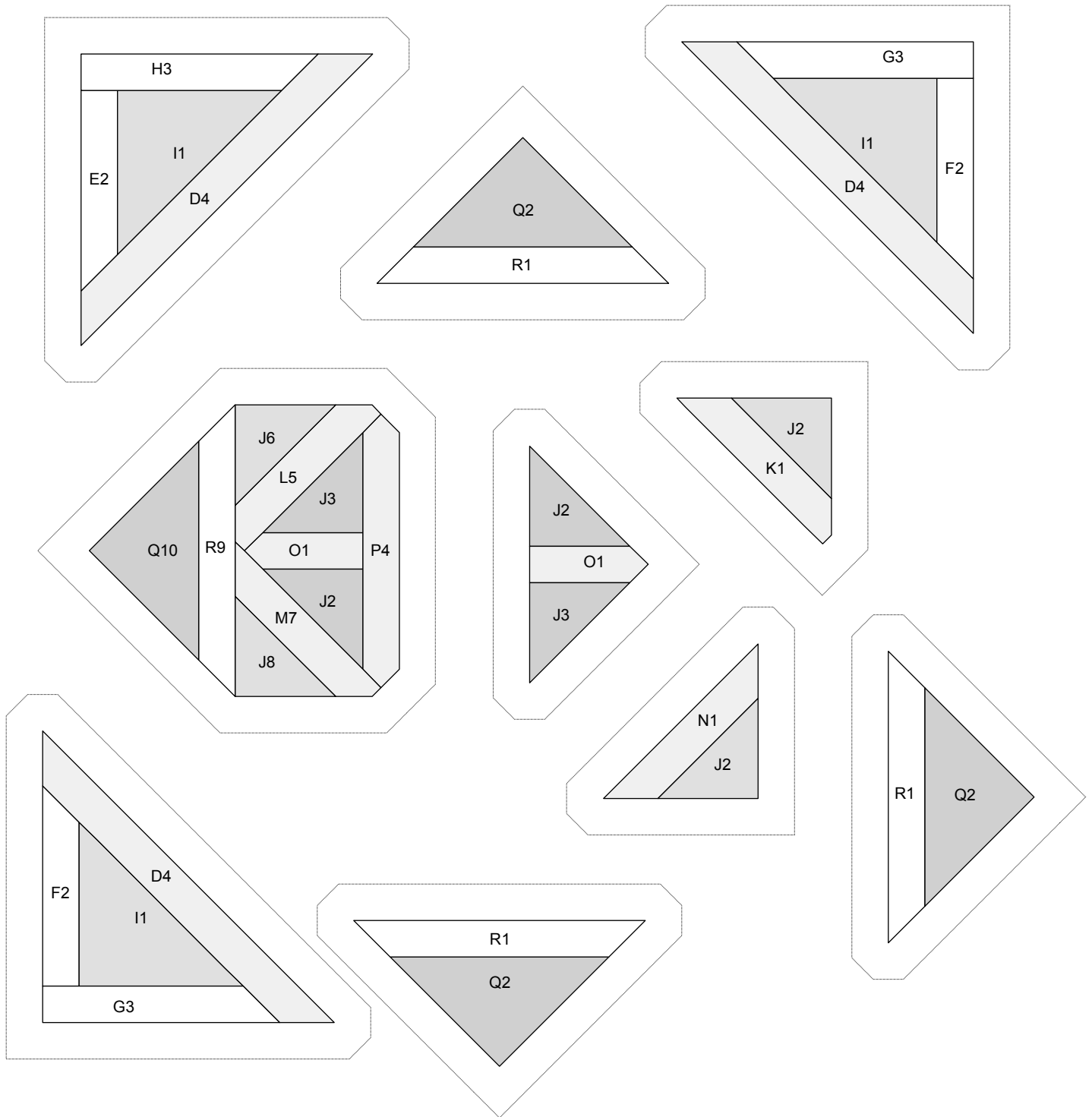

SET PRINTER TO "ACTUAL SIZE" WHEN PRINTING THIS PAGE.

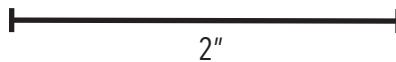
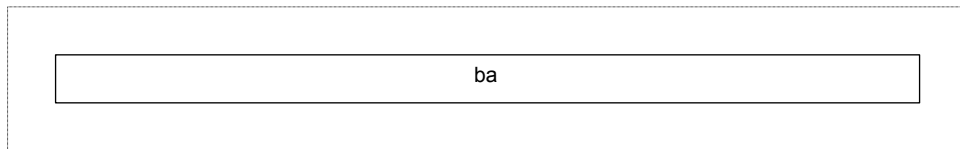
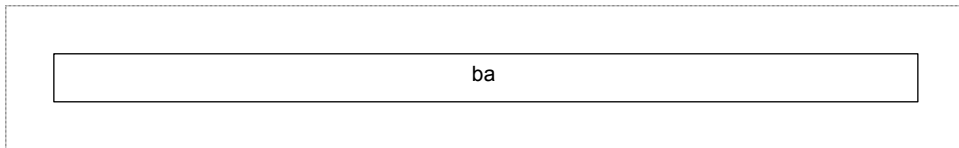
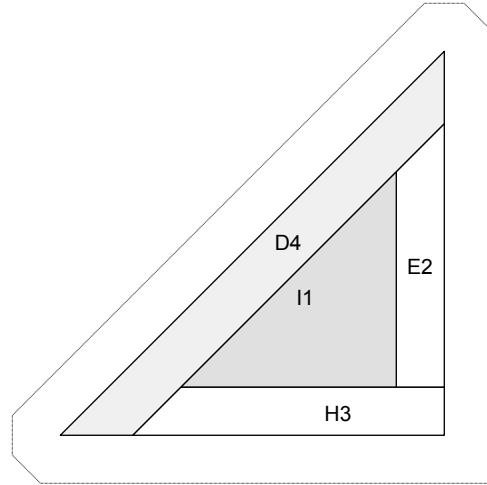
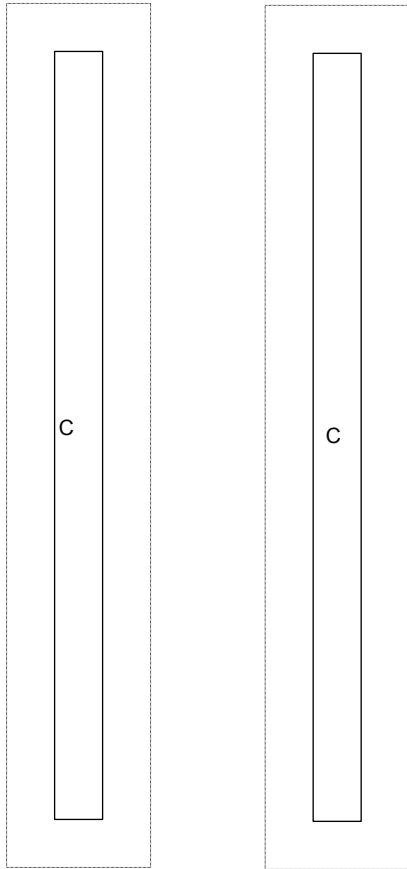

SET PRINTER TO "ACTUAL SIZE" WHEN PRINTING THIS PAGE.

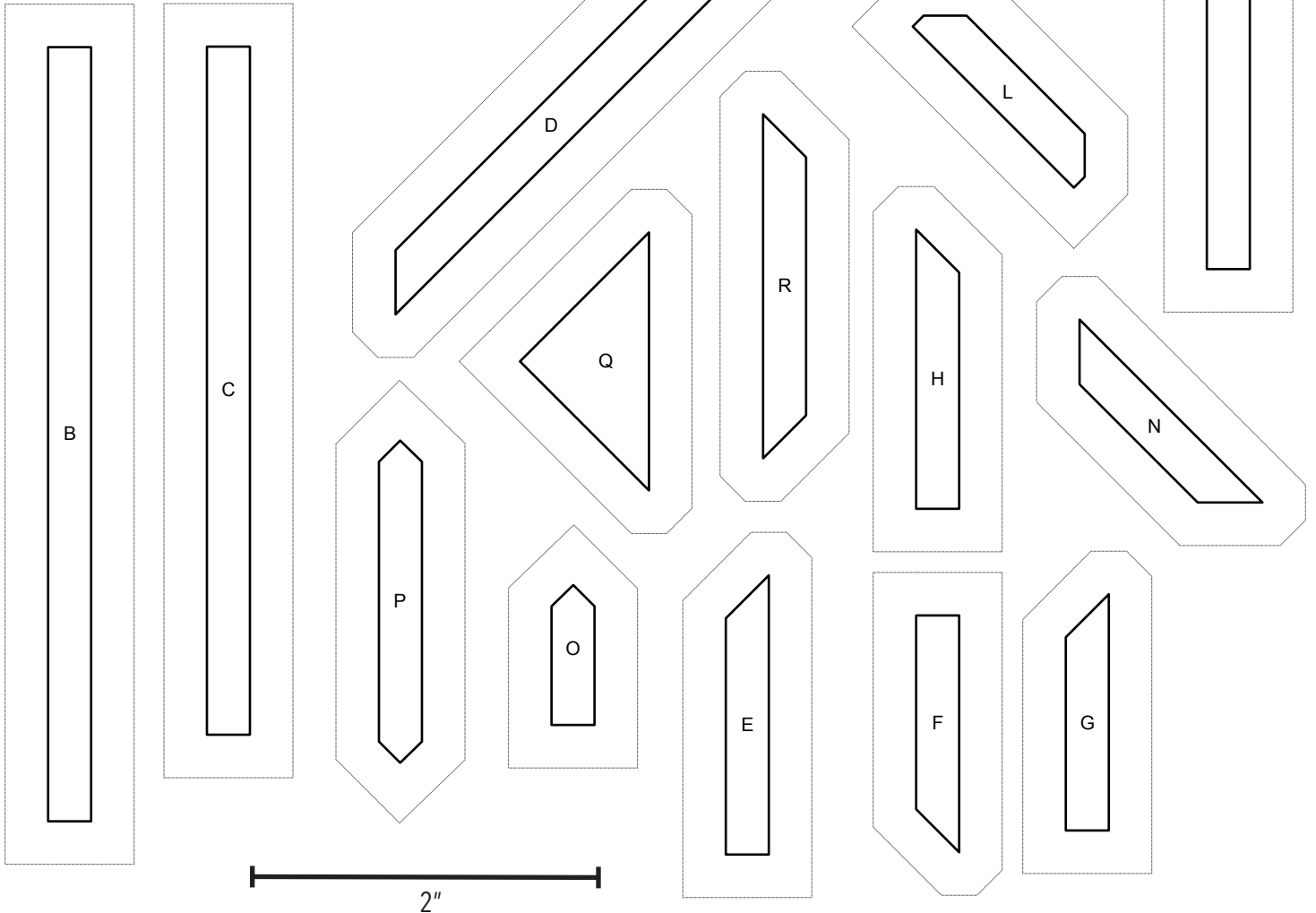
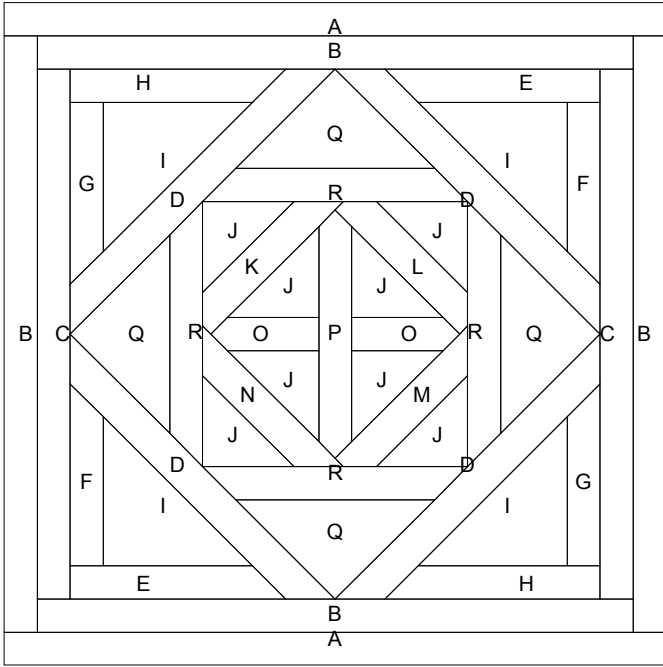



## The Jane Stickle Quilt - Block B7

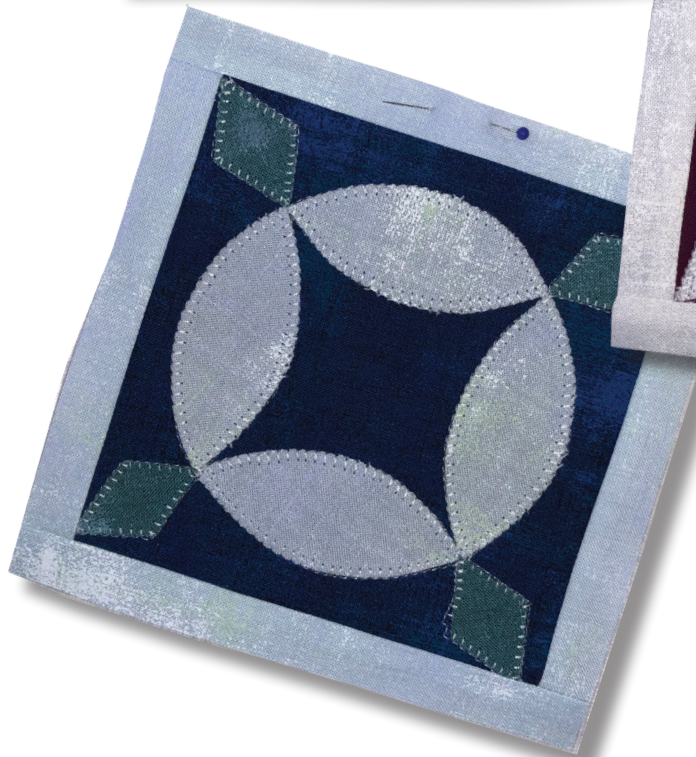



### What you need:

Units	Quantity/size
A*	(2) 1" x 6"
B*	(2) 1" x 5"
C	(1) 6" x 6"
D	(4) 2" x 2"
E	(4) 2" x 4"

*\*The actual required width for Unit A and Unit B units is ¾". The increased width specified above allows for squaring the block to exactly 5½".*

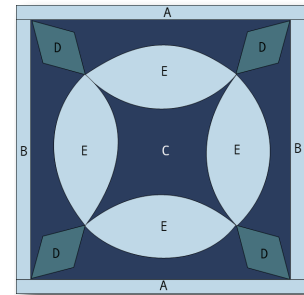

*Hobbystash Colorway*

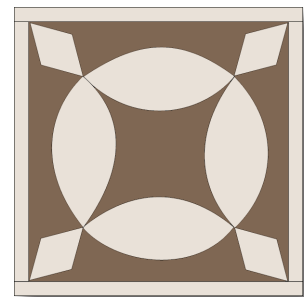

*Jane Stickle Colorway*

### Assembly:

1. Using the templates provided on page B7-2, appliqué the four melon units and four diamond units to Unit C of the block. When all the units have been appliquéed to Unit C, trim the block to 5" x 5" square.
2. Join Unit B to the right side of the block, and then the left.
3. Join Unit A to the top of the block and then the bottom. Square up block to measure 5½" x 5½".

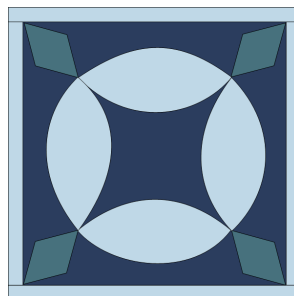

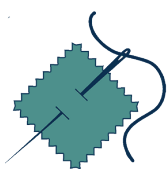

SET PRINTER TO "ACTUAL SIZE" WHEN PRINTING THIS PAGE.

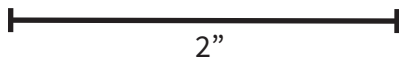
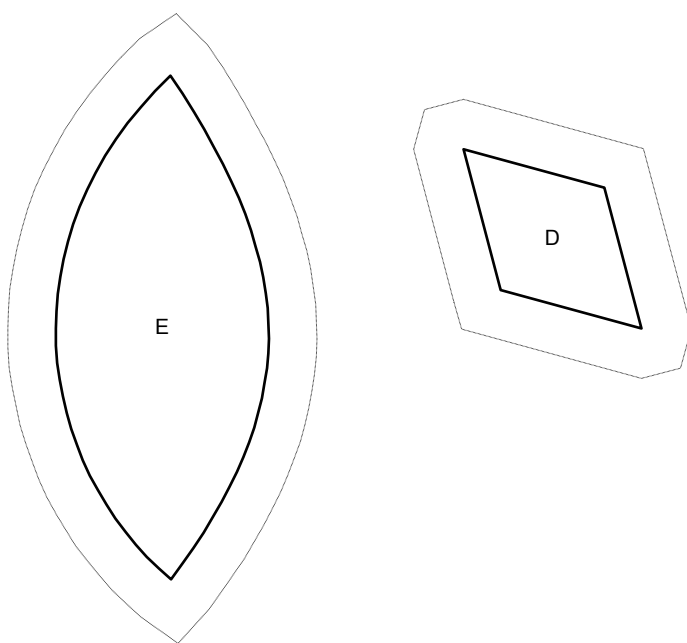

SET PRINTER TO "ACTUAL SIZE" WHEN PRINTING THIS PAGE.

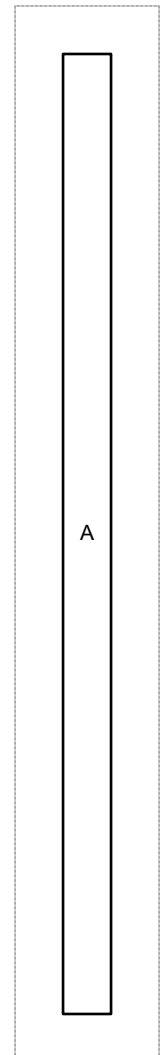
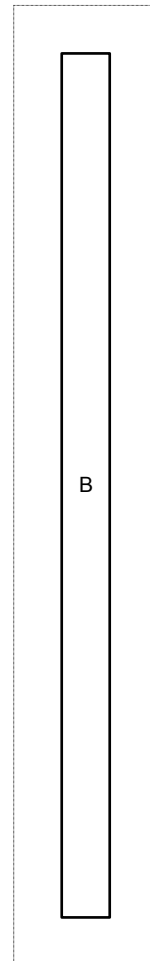
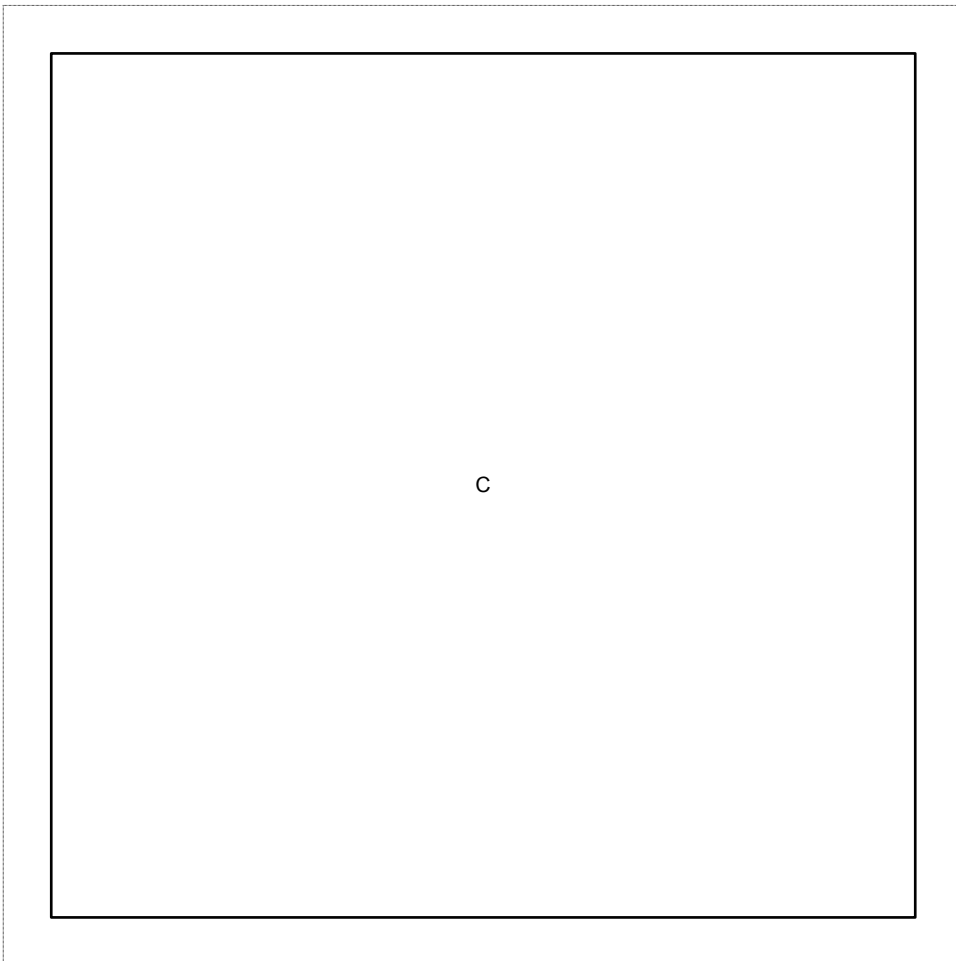
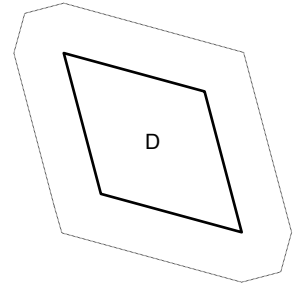
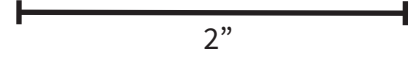
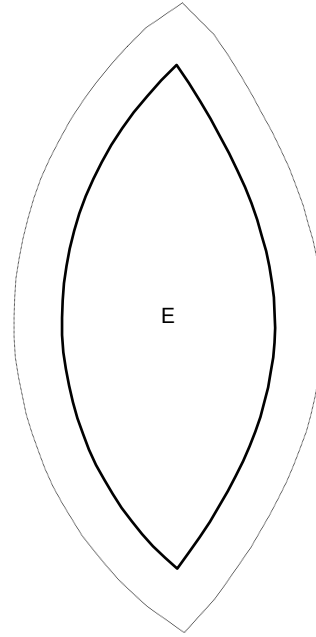
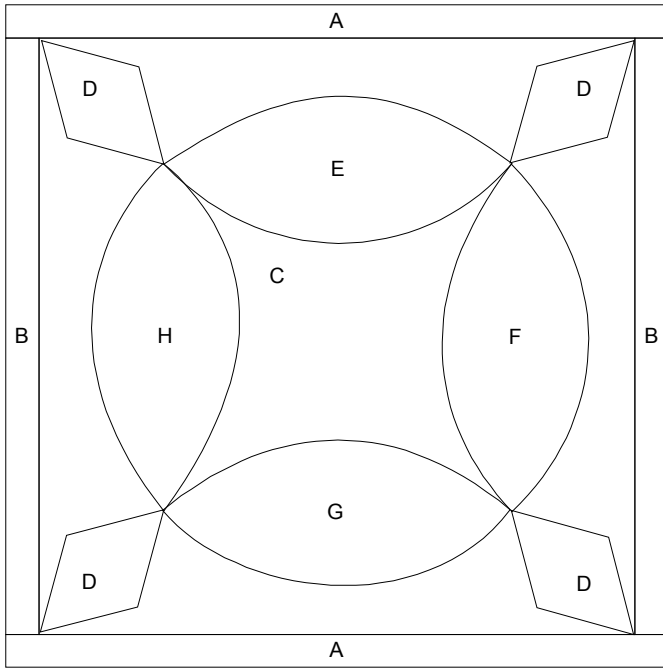

## The Jane Stickle Quilt - Block B8

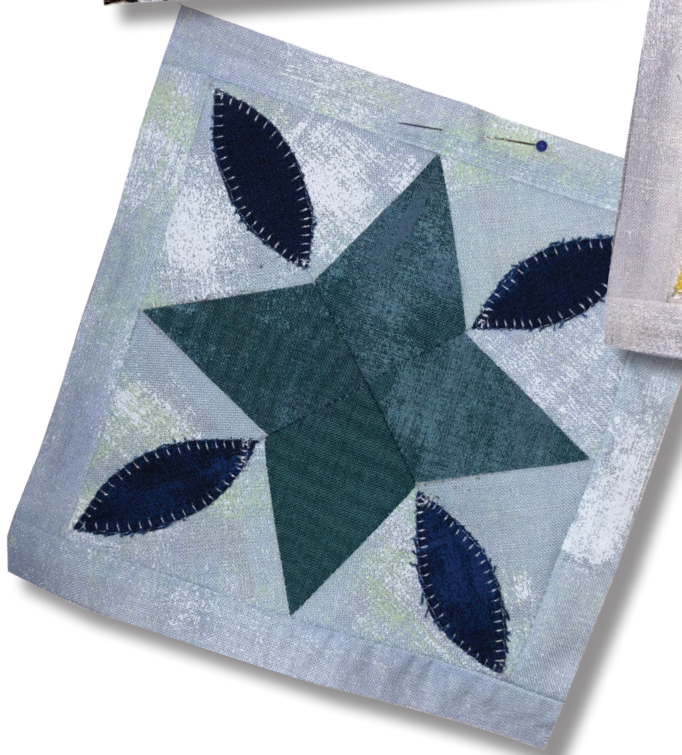

### What you need:

Units	Quantity/size
A*	(2) 1" x 6"
B*	(2) 1" x 5"
C	(4) 2½" X 3½"
D	(4) 2½" X 3½"
E	(4) 3" X 3½"
F	(4) 2" x 3"

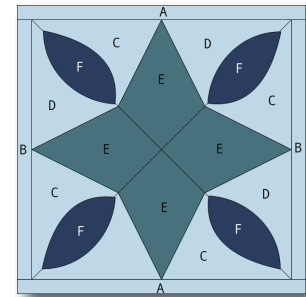

Hobbystash Colorway

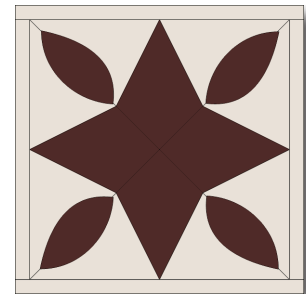

Jane Stickle Colorway

*\*The actual required width for Unit A and Unit B units is ¾". The increased width specified above allows for squaring the block to exactly 5½".*

### Assembly:

- Using the templates provided on Page B8-2, create the four foundation sections. Join the sections together .
- Using the template provided on Page B8-3, applique the leaf pieces to the block.
- Join Unit B to the right side of the block, and then the left.
- Join Unit A to the top of the block and then the bottom. Square up block to measure 5½" x 5½"



Step 1

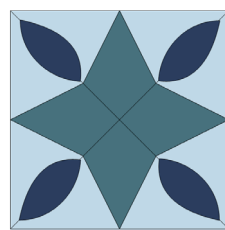

Step 2

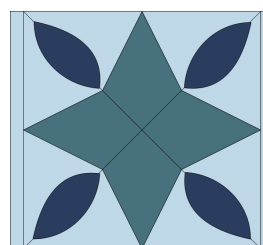

Step 3

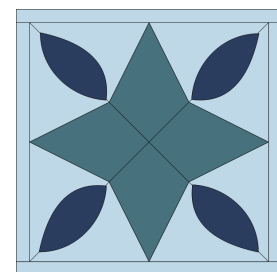

Step 4

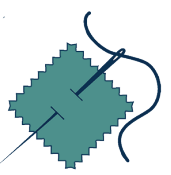

SET PRINTER TO "ACTUAL SIZE" WHEN PRINTING THIS PAGE.

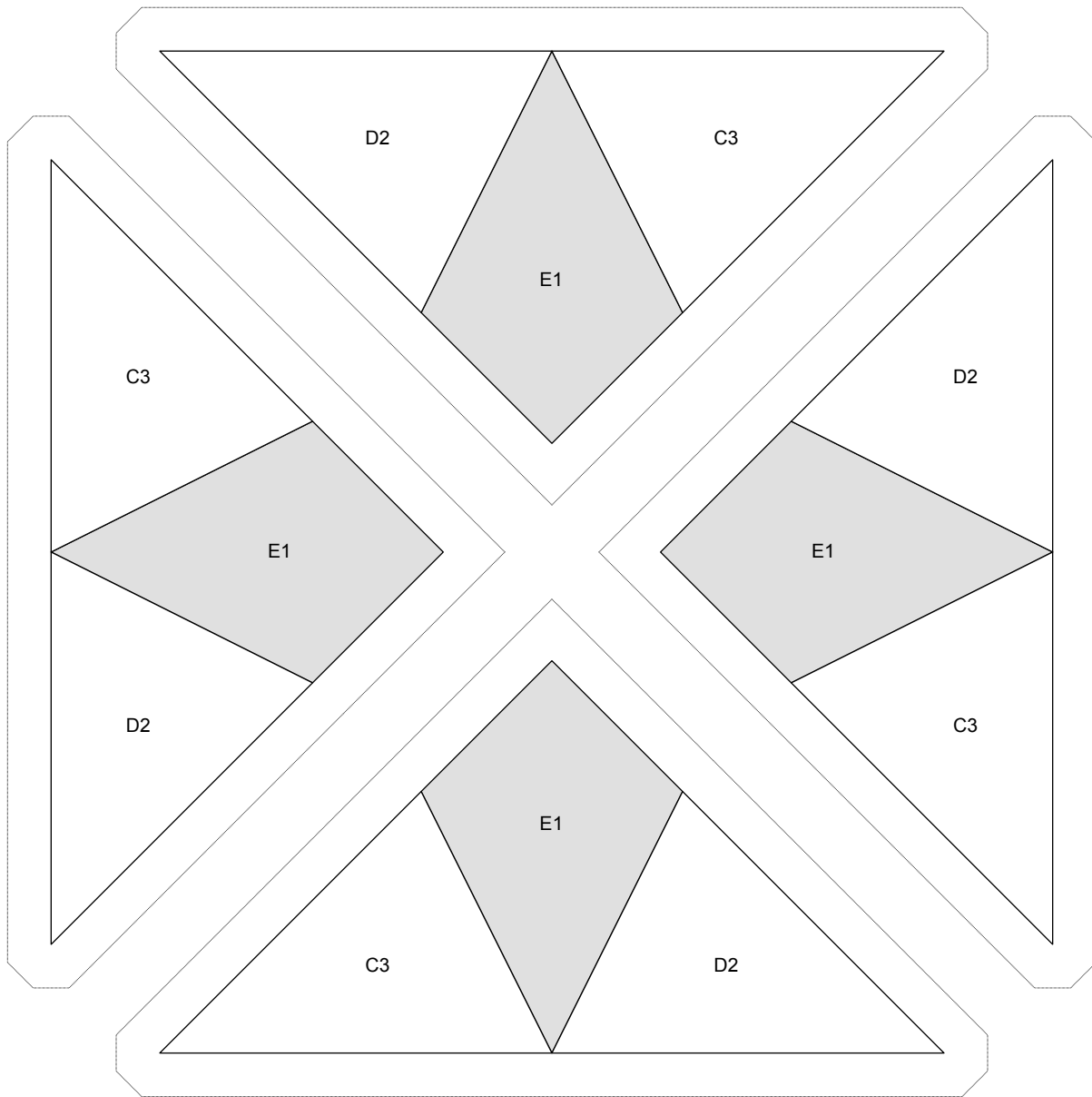



SET PRINTER TO "ACTUAL SIZE" WHEN PRINTING THIS PAGE.

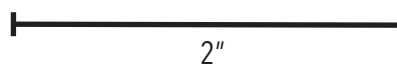
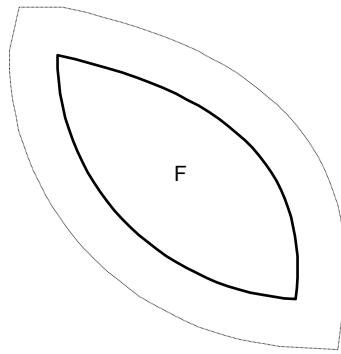

SET PRINTER TO "ACTUAL SIZE" WHEN PRINTING THIS PAGE.

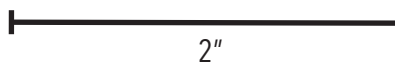
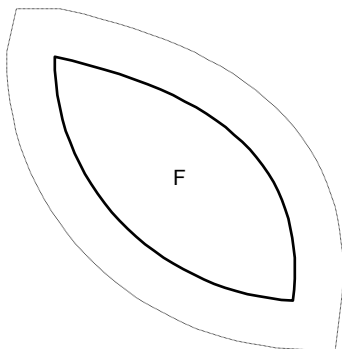
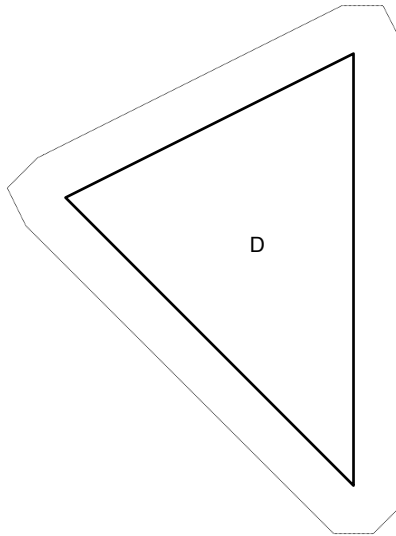
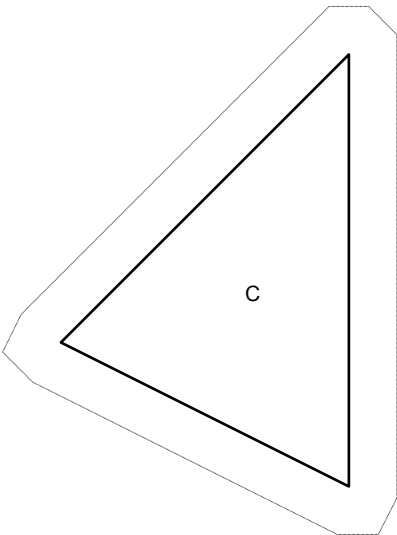
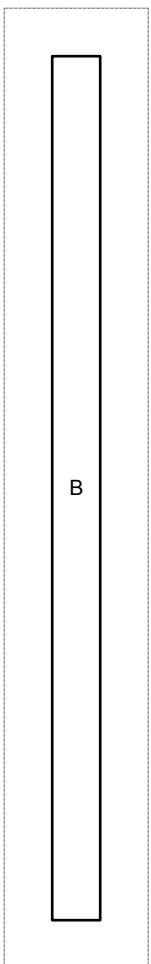
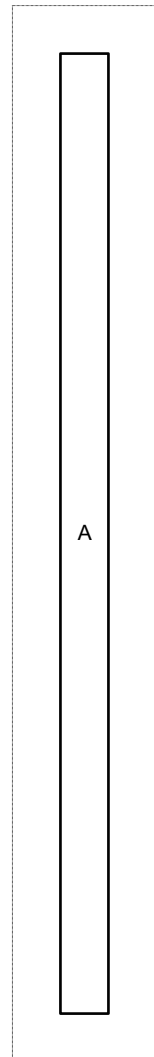
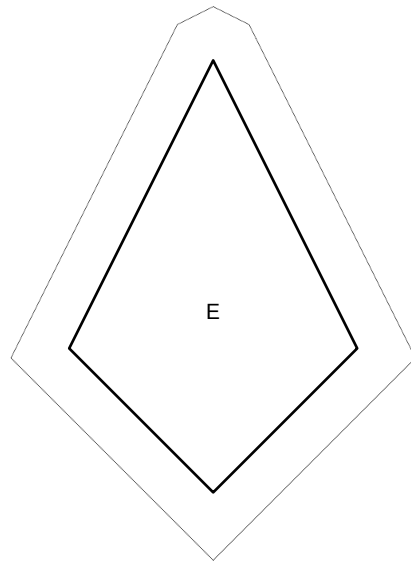
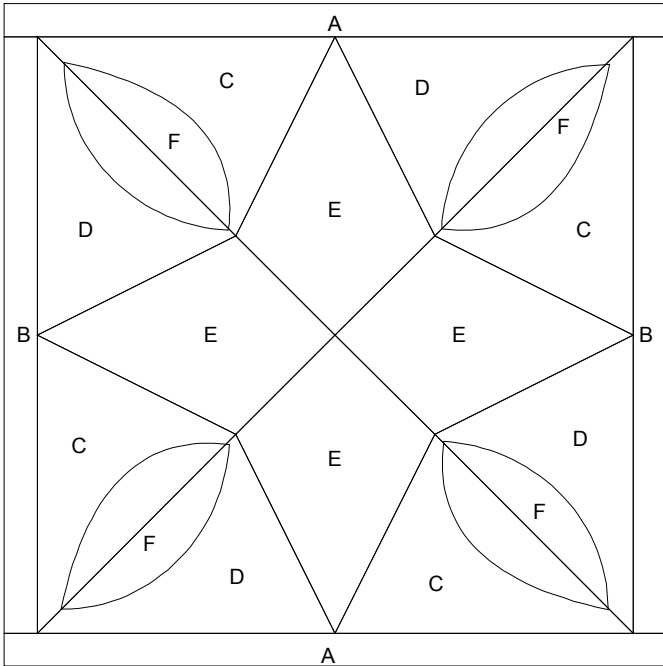

## The Jane Stickle Quilt - Block B9

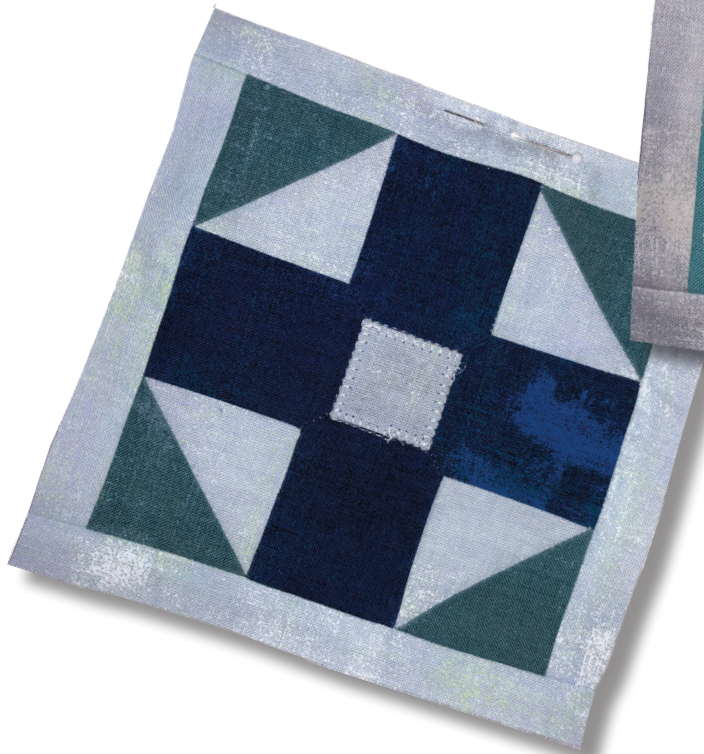

### What you need:

Units	Quantity/size
A*	(2) 1" x 6"
B*	(2) 1" x 5"
C	(2) 2¾" X 2¾", cut once diagonally-green (2) 2¾" X 2¾", cut once diagonally-lt blue
D	(4) 2½" X 3½"
E	(1) 2" x 2"

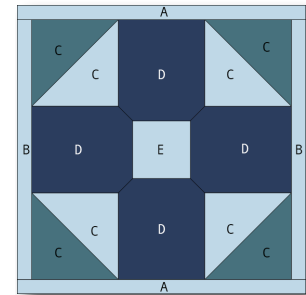

*Hobbystash Colorway*

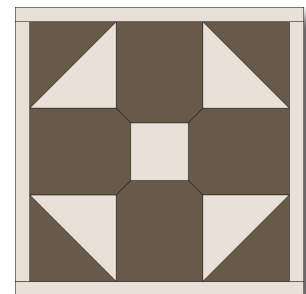

*Jane Stickle Colorway*

*\*The actual required width for Unit A and Unit B units is ¾". The increased width specified above allows for squaring the block to exactly 5½".*

### Assembly:

- Using the templates provided on Page B9-2 or Page B9-5, create the foundation sections. Join the sections together.
- Using the template provided on Page B9-3, applique the square piece to the block center. (Eliminate this step if using Page B9-5 templates.)
- Join Unit B to the right side of the block, and then the left.
- Join Unit A to the top of the block and then the bottom. Square up block to measure 5½" x 5½"



*Step 1a*



*Step 1b*

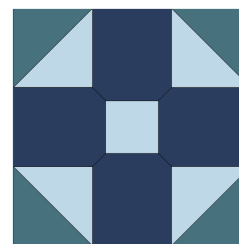

*Step 2*

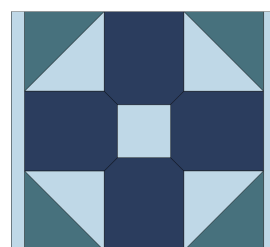

*Step 3*

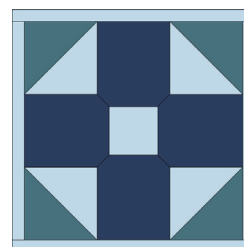

*Step 4*

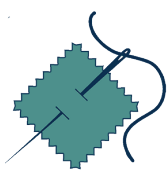

SET PRINTER TO "ACTUAL SIZE" WHEN PRINTING THIS PAGE.

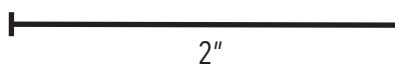
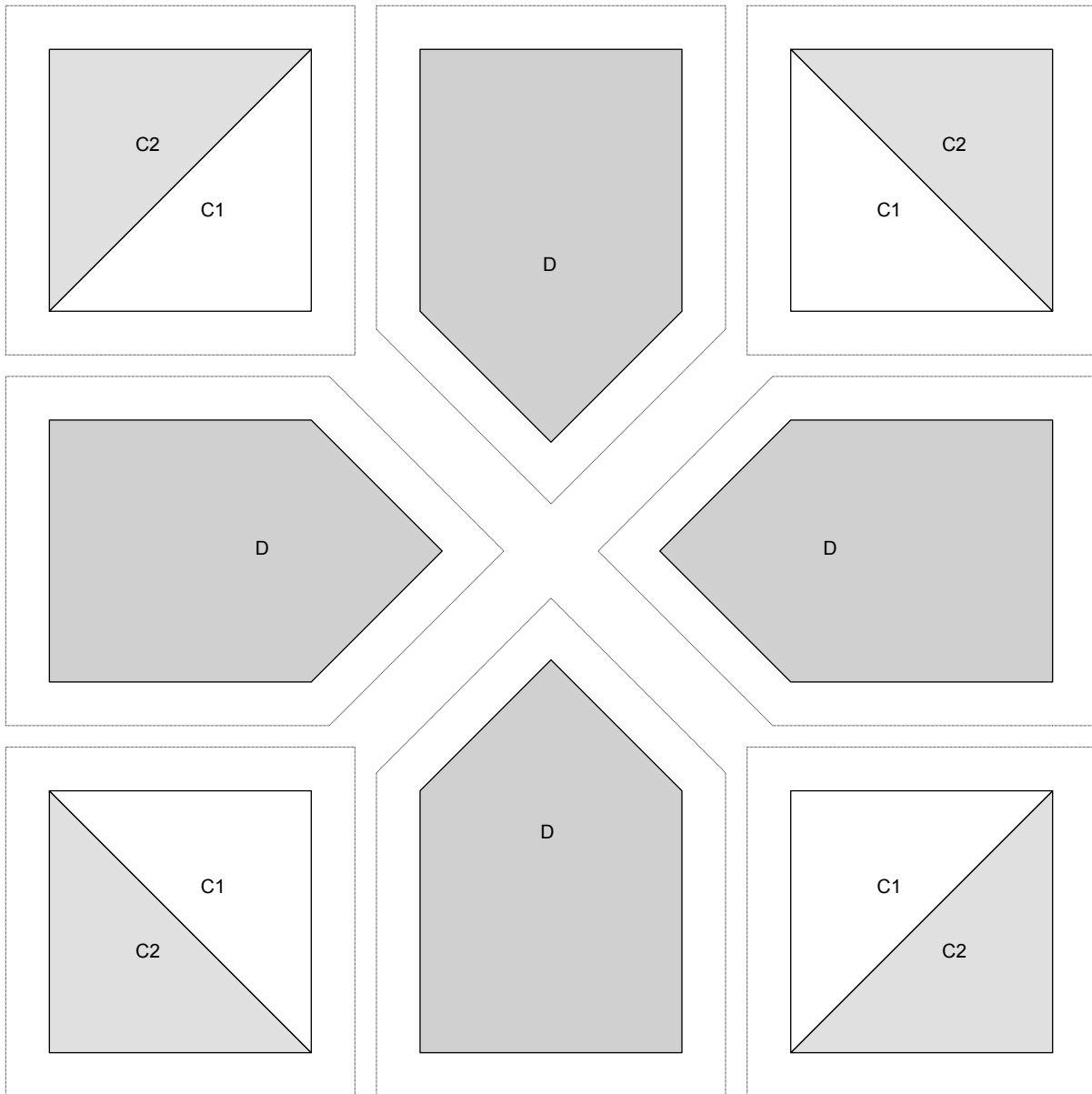

SET PRINTER TO "ACTUAL SIZE" WHEN PRINTING THIS PAGE.

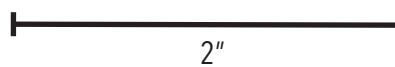
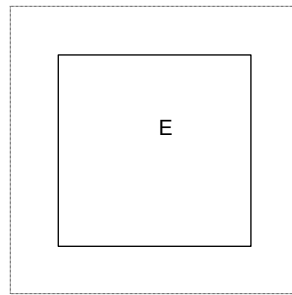



SET PRINTER TO "ACTUAL SIZE" WHEN PRINTING THIS PAGE.

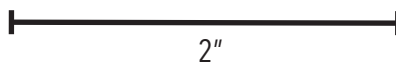
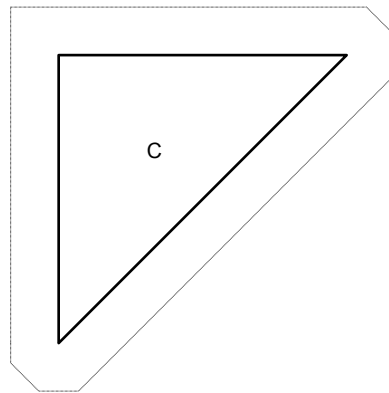
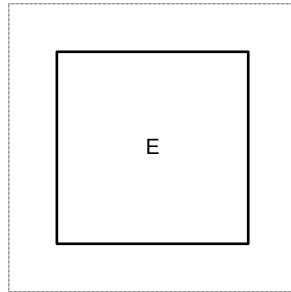
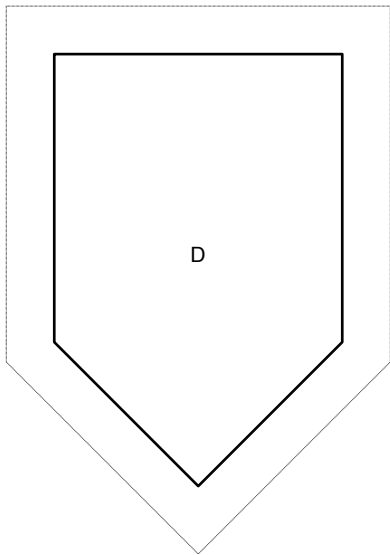
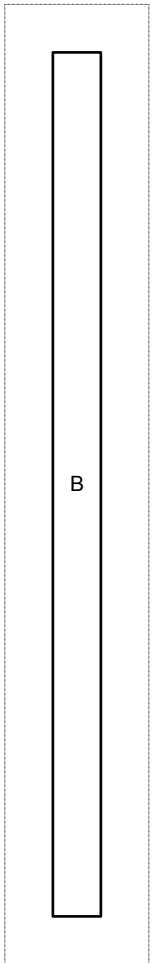
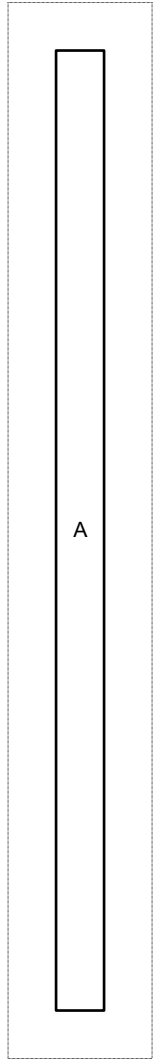
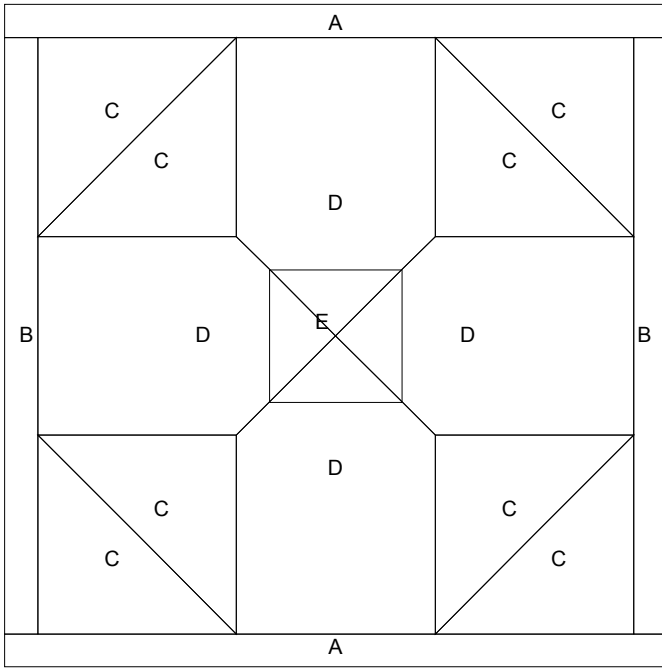

**SET PRINTER TO "ACTUAL SIZE" WHEN PRINTING THIS PAGE.**

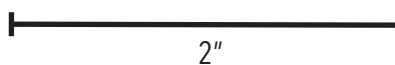
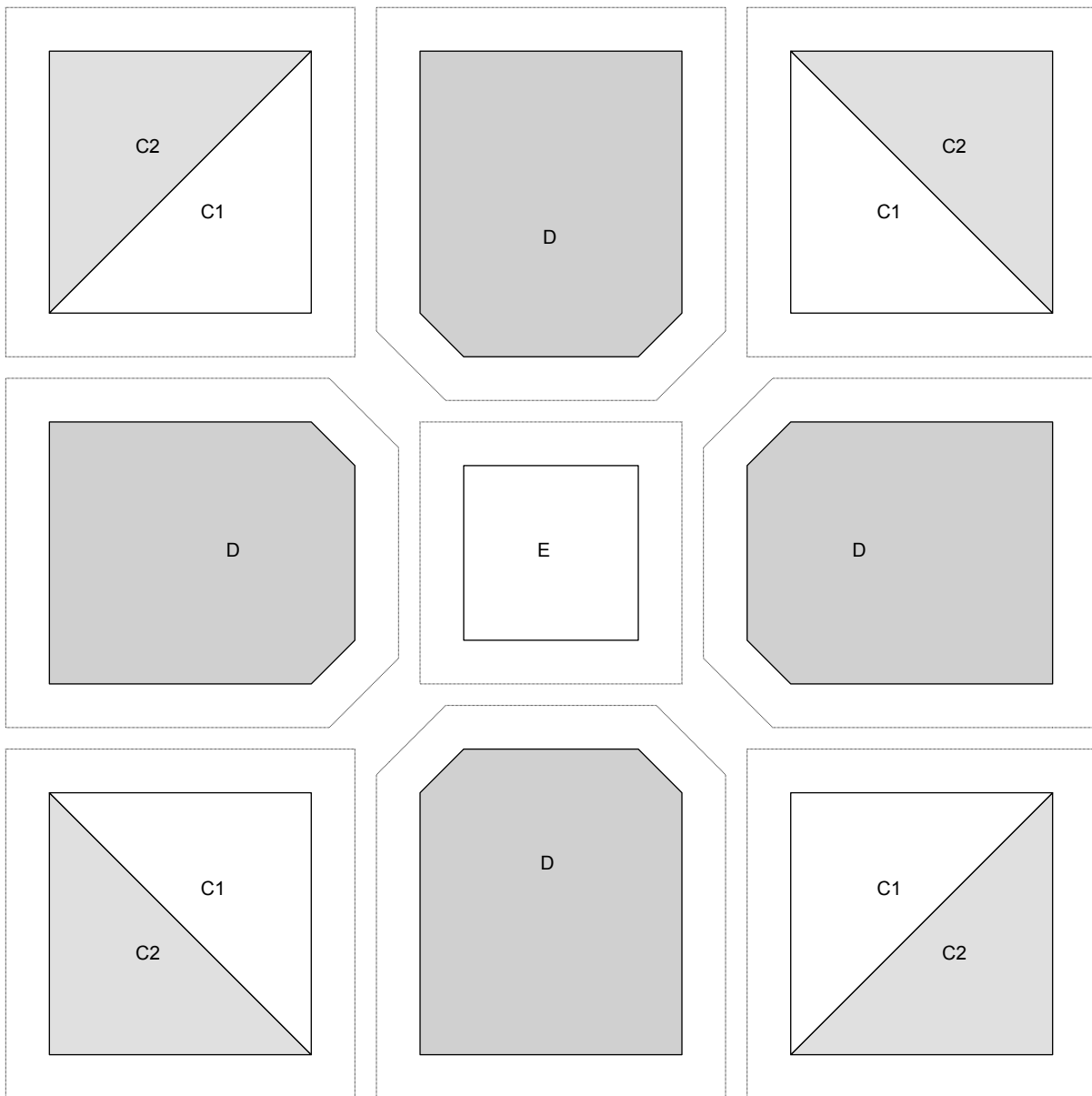

This template more accurately reflects the original block. The center square is part of the piecing. As a result, "Y" seams will be necessary to join the cross pieces as they meet the center patch.



## The Jane Stickle Quilt - Block B10



### What you need:

Units	Quantity/size
A*	(2) 1" x 6"
B*	(2) 1" x 5"
C	(2) 1½" x 5½"
D	(2) 1½" x 4½"
E	(4) 1½" x 1½"
F	(4) 1½" x 2½"
G	 (2) 2" x 2", cut once diagonally
H	(1) 1½" x 2"
I	 (1) 2" x 2" cut twice diagonally
J	 (2) 1½" x 1½", cut once diagonally
K	(2) 1½" x 1½"

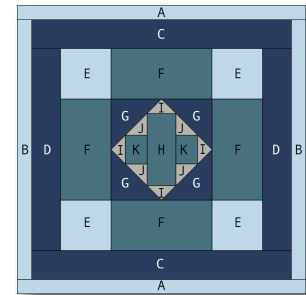

*Hobbystash Colorway*

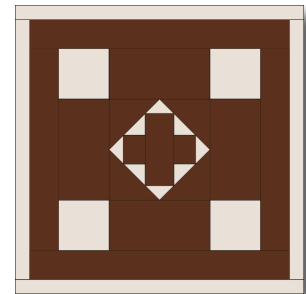

*Jane Stickle Colorway*

*\*The actual required width for Unit A and Unit B units is ¾". The increased specified width allows for squaring the block to exactly 5½".*

### Assembly:

1. Using the templates provided on Page B10-2, foundation piece the ten sections.
2. Join the sections together.
3. Join Unit B to the right side of the block, and then the left.
4. Join Unit A to the top of the block and then the bottom. Square up block to measure 5½" x 5½"

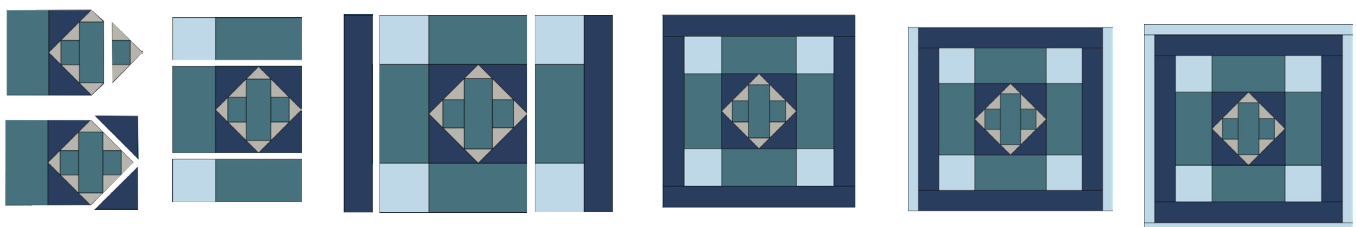

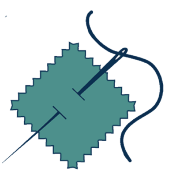

SET PRINTER TO "ACTUAL SIZE" WHEN PRINTING THIS PAGE.

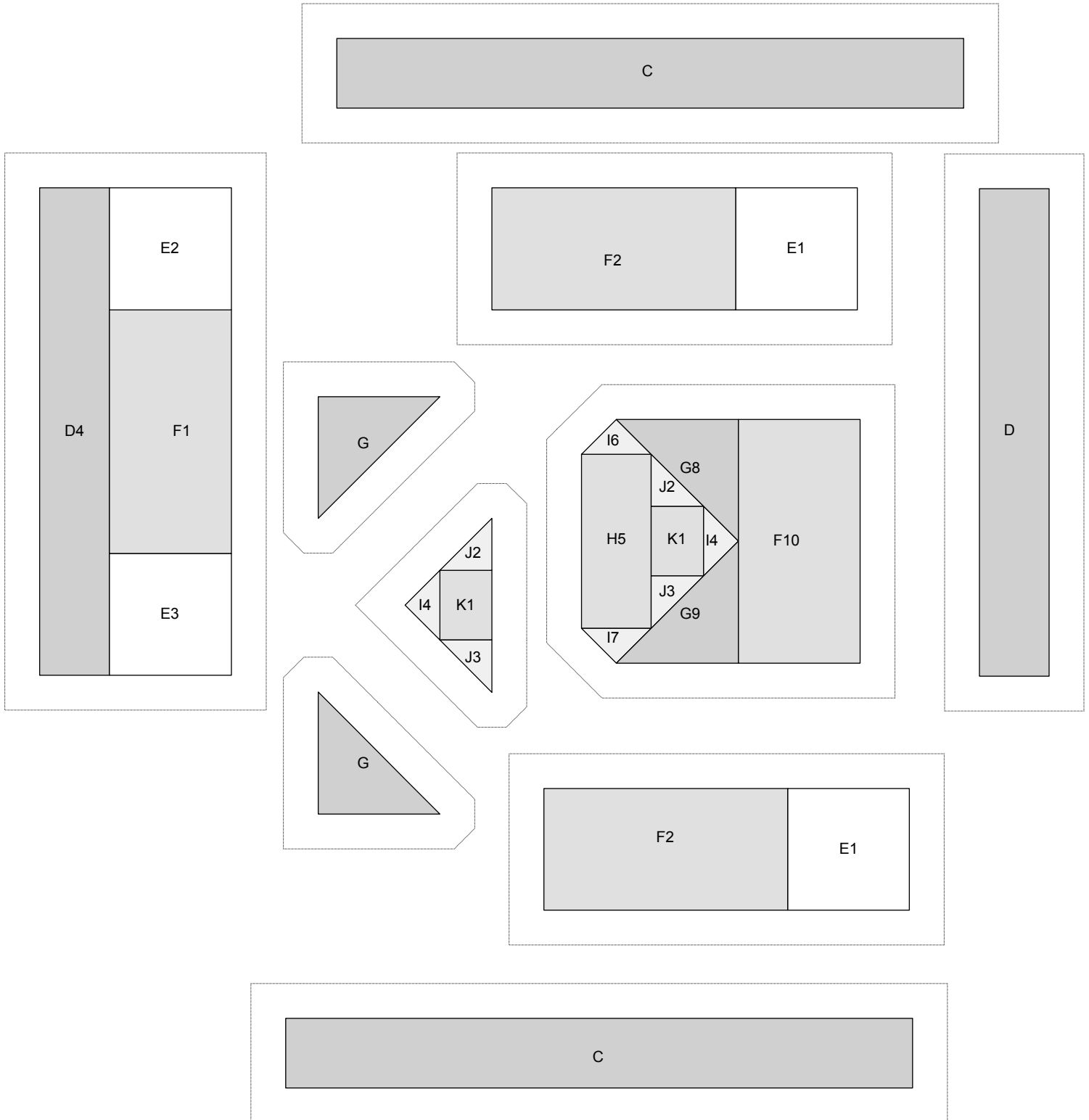

2"



SET PRINTER TO "ACTUAL SIZE" WHEN PRINTING THIS PAGE.

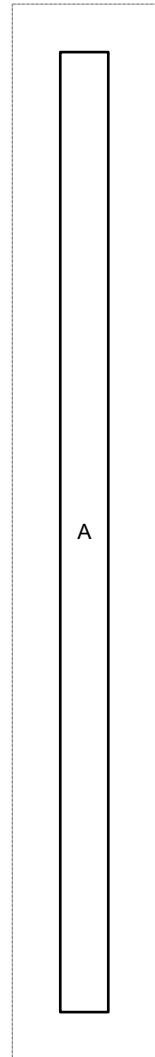
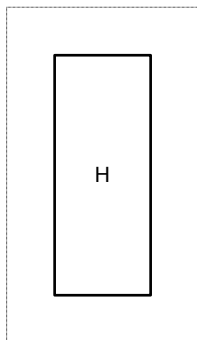
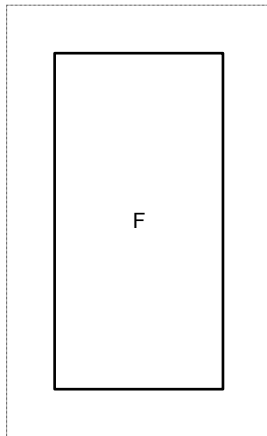
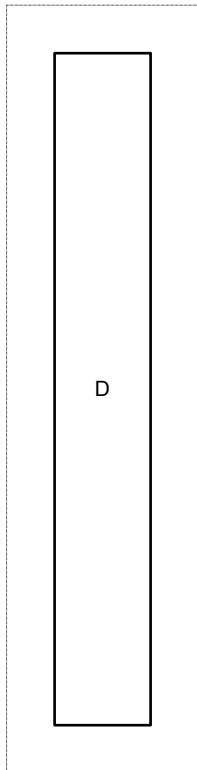
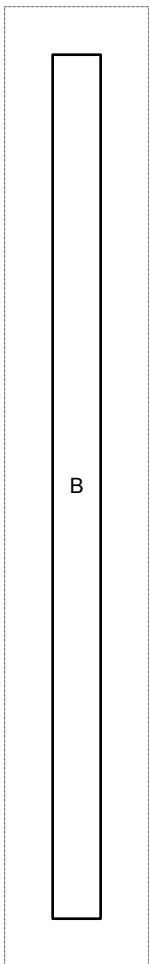
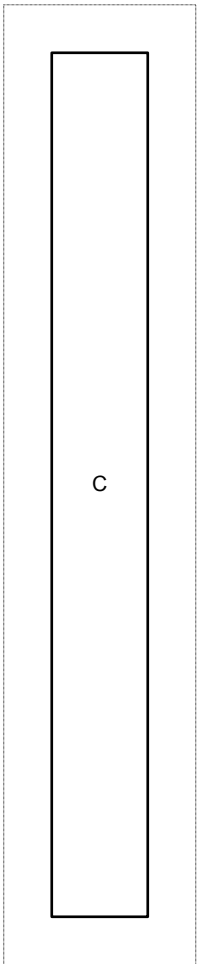
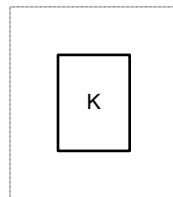
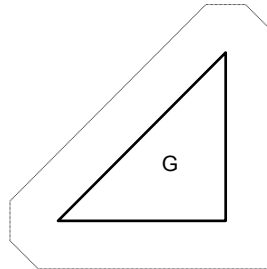
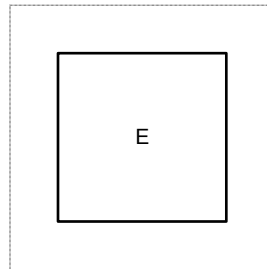
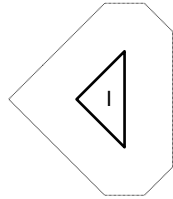
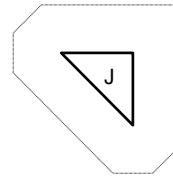
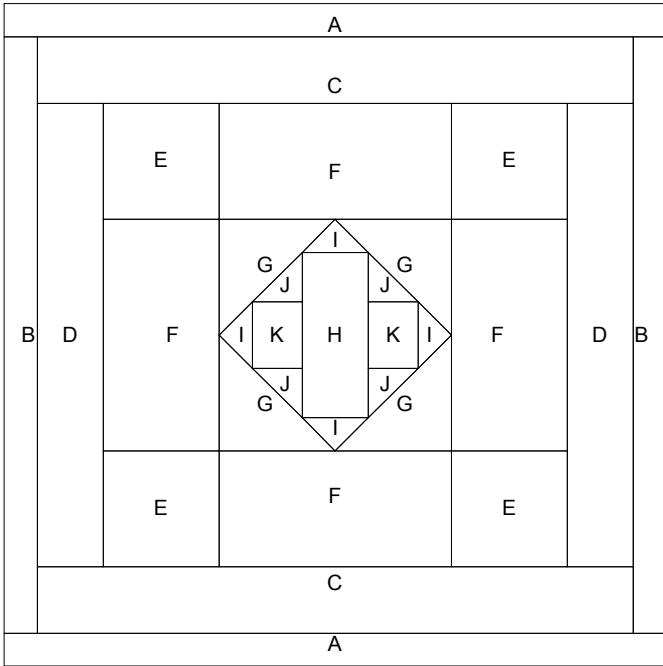

2"

## The Jane Stickle Quilt - Block B11

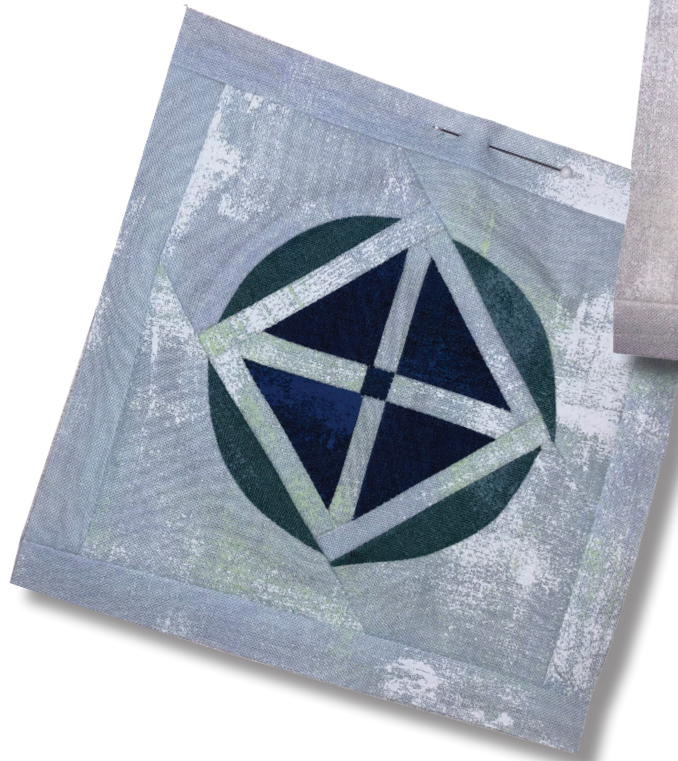

### What you need:

Units	Quantity/size
A*	(2) 1" x 6"
B*	(2) 1" x 5"
C	(2) 3½" x 3½"
D	(1) 4" x 4", cut once diagonally
E/F	(4) 1½" x 3½"
G	(2) 1" x 3½"
H	(2) 1" x 3"
I	(4) 1" x 2"
J	(2) 2½" x 2½", cut once diagonally
K	(1) 1" x 1"

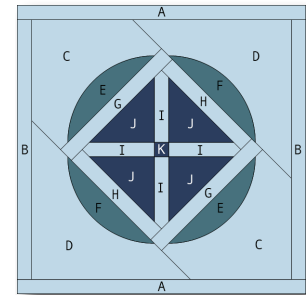

Hobbystash Colorway

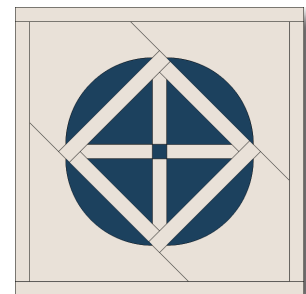

Jane Stickle Colorway

*\*The actual required width for Unit A and Unit B units is ¾".  
The increased width specified above allows for squaring the block to exactly 5½".*

### Assembly:

1. For appliqué, use the templates on Page B11-3 to attach melon Units E and F to corner Units C and D. For curved piecing, use the templates on Page B11-4.
2. Using the templates on Page B11-2, foundation piece the remaining sections of the block. Sew the sections together.
3. Join Unit B to the right side of the block, and then the left.
4. Join Unit A to the top of the block and then the bottom. Square up block to measure 5½" x 5½"

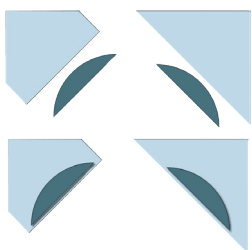

Step 1

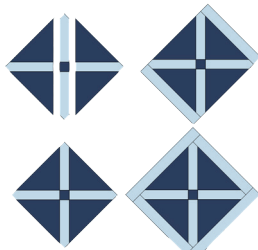

Step 2a

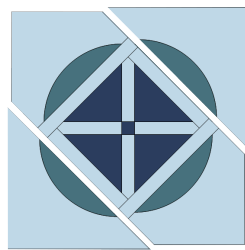

Step 2b

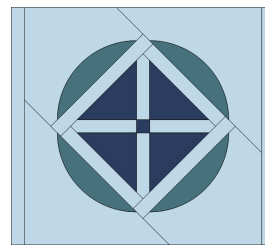

Step 3

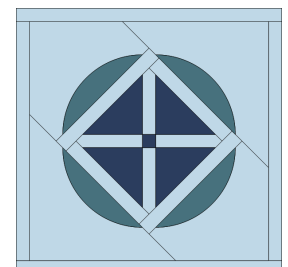

Step 4

SET PRINTER TO "ACTUAL SIZE" WHEN PRINTING THIS PAGE.

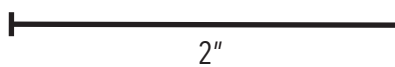
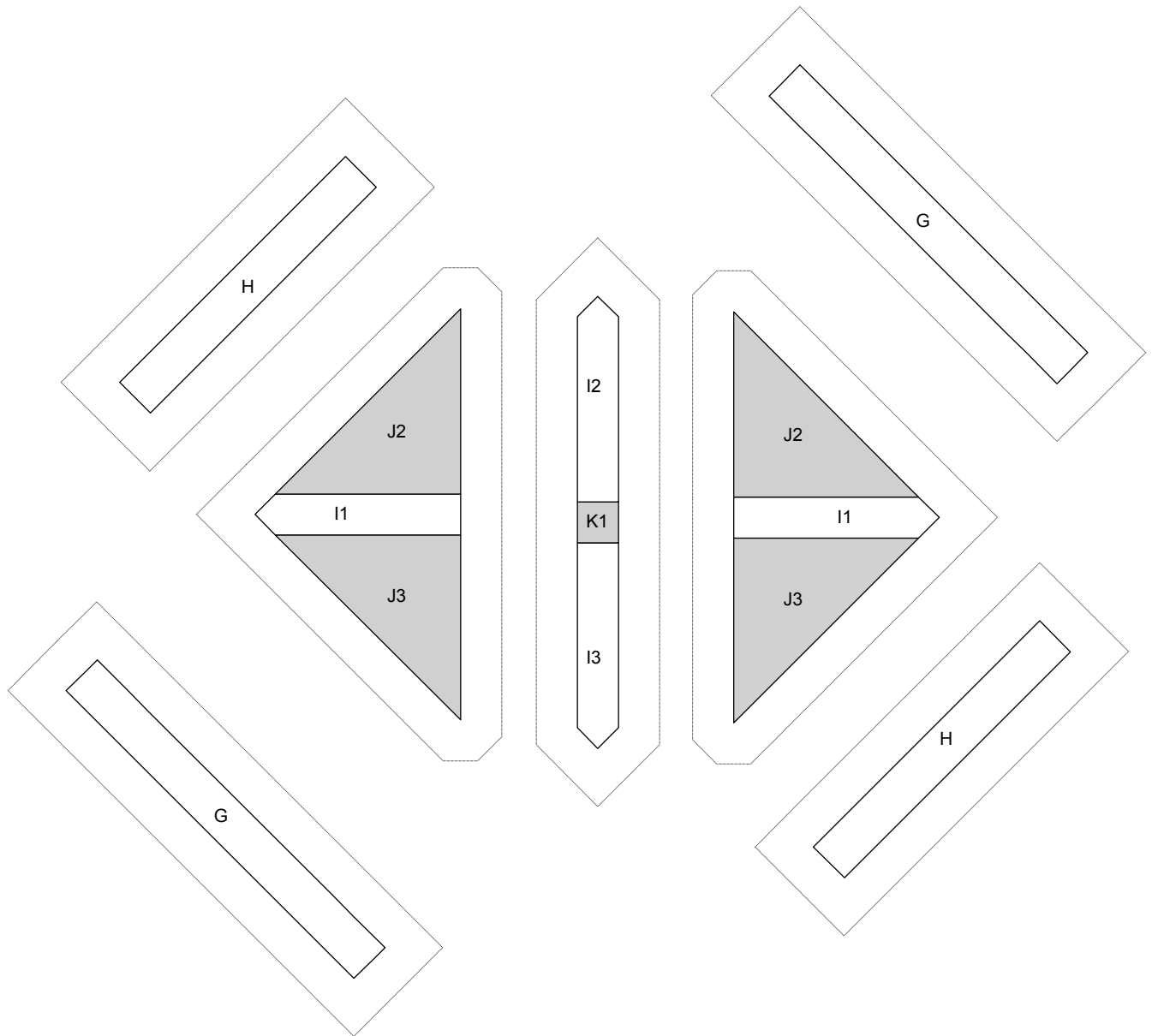

SET PRINTER TO "ACTUAL SIZE" WHEN PRINTING THIS PAGE.

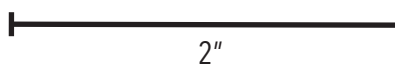
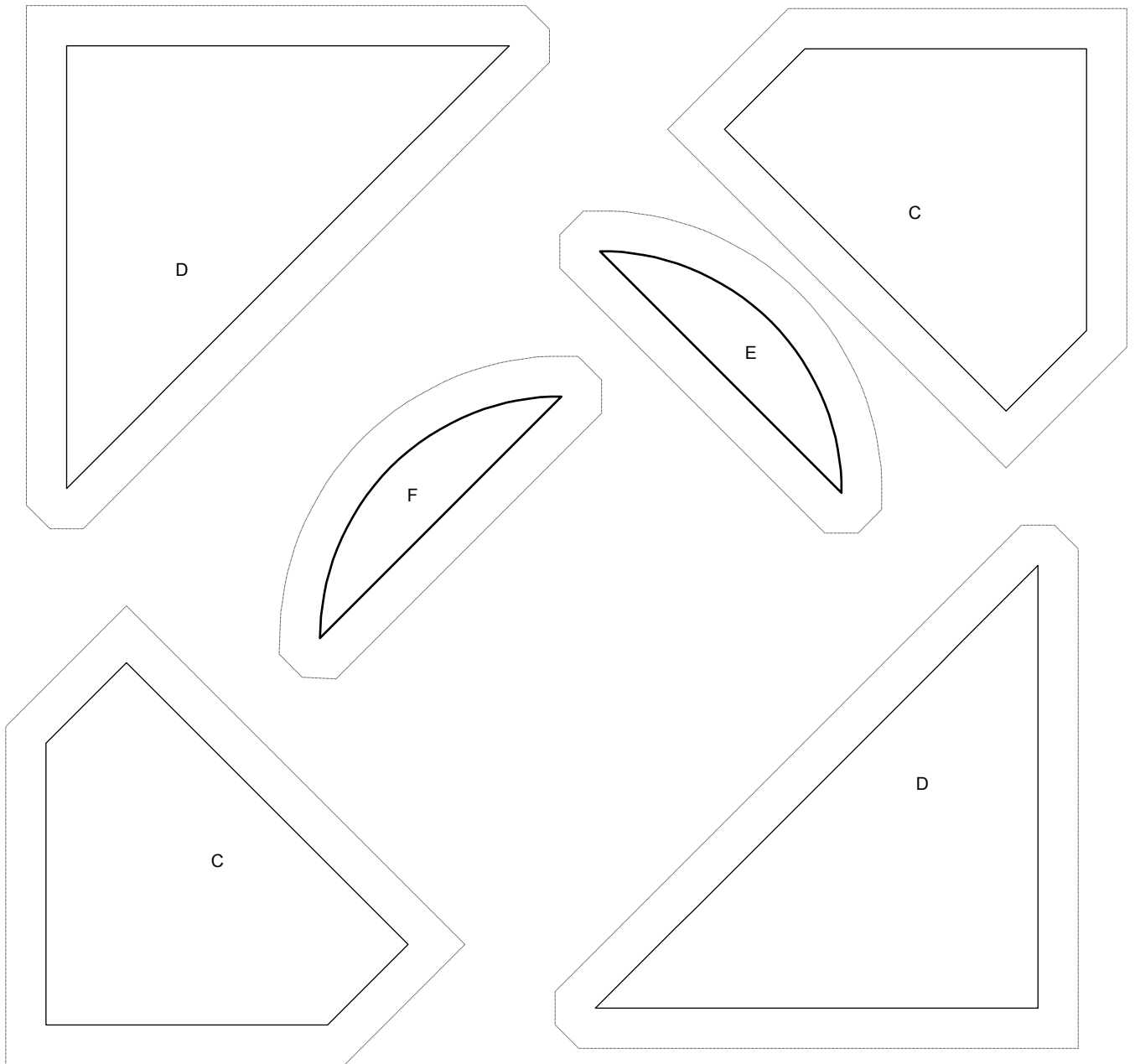

SET PRINTER TO "ACTUAL SIZE" WHEN PRINTING THIS PAGE.

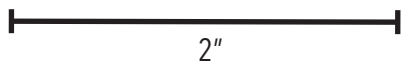
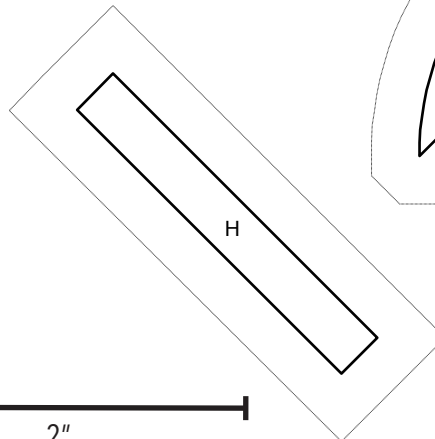
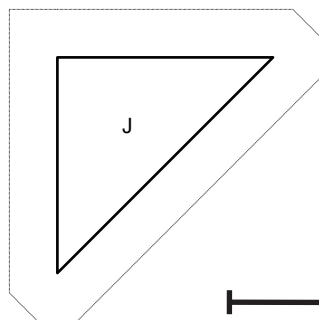
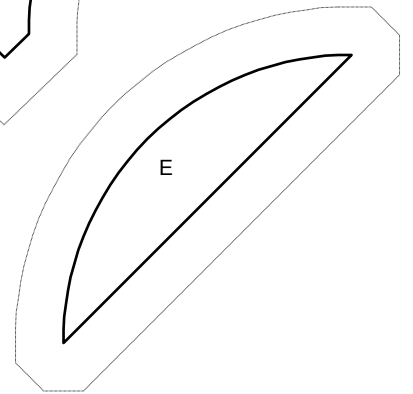
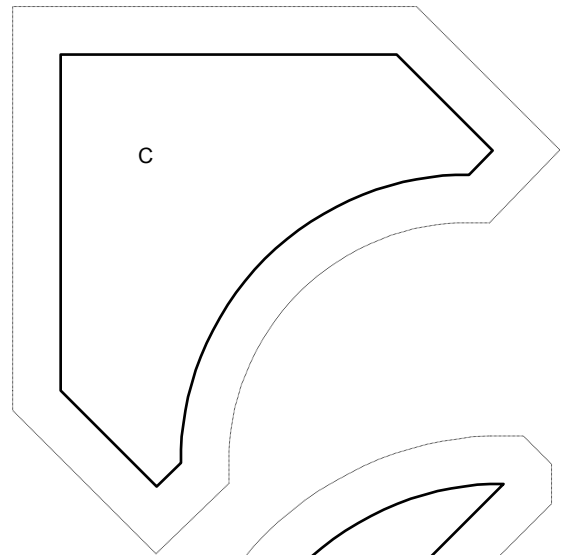
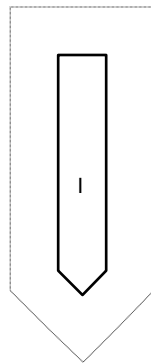
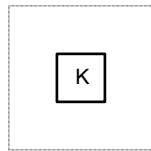
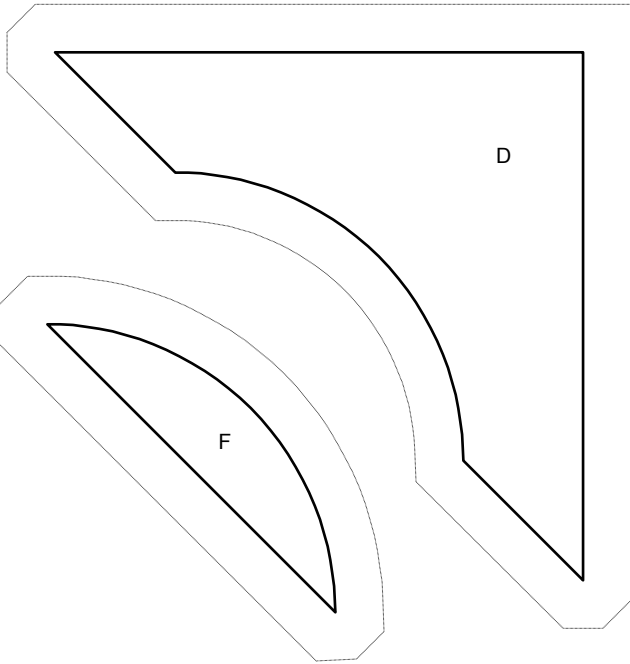
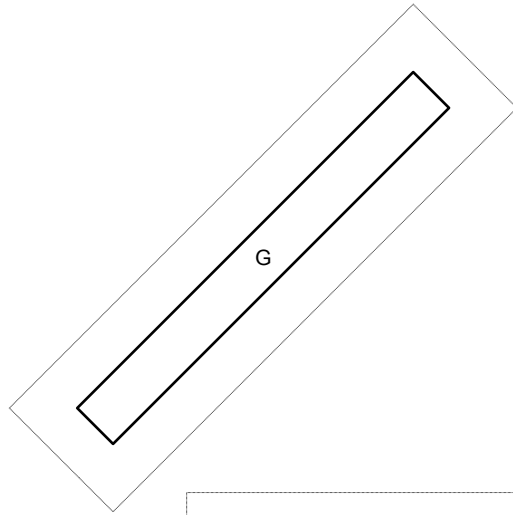
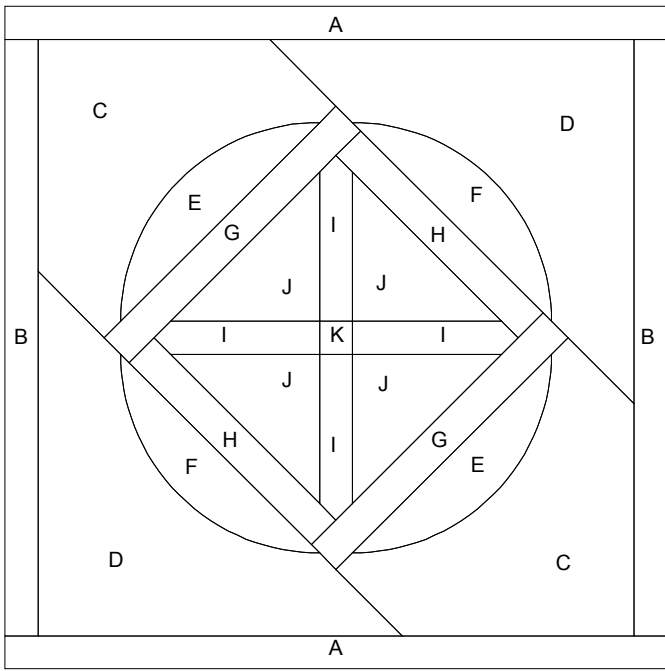



## The Jane Stickle Quilt - Block B12

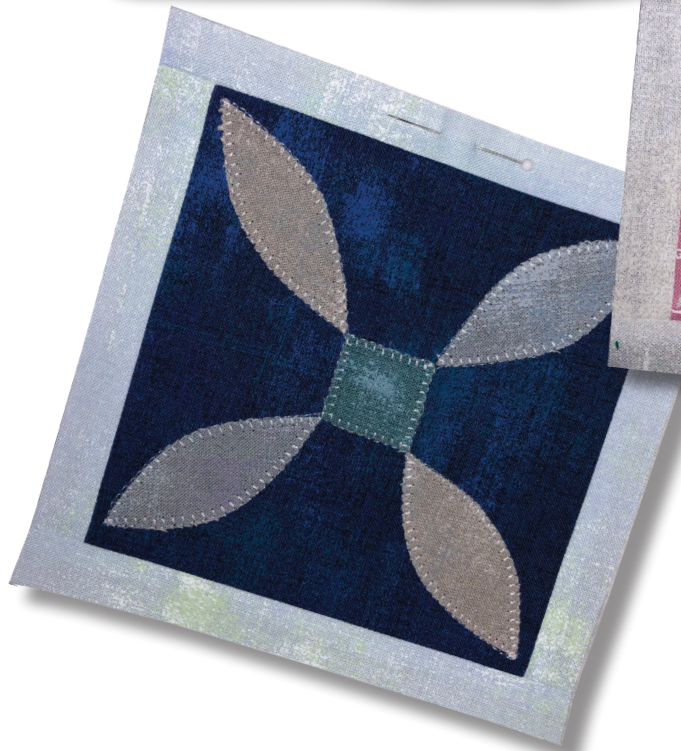

### What you need:

Units	Quantity/size
A*	(2) 1" x 6"
B*	(2) 1" x 5"
C	(1) 6" x 6"
D	(4) 2" x 2"
E	(4) 2" x 4"

*\*The actual required width for Unit A and Unit B units is ¾". The increased width specified above allows for squaring the block to exactly 5½".*

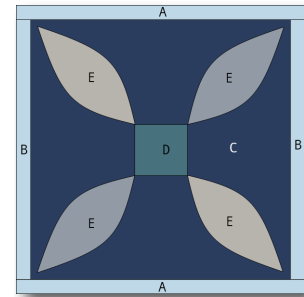

*Hobbystash Colorway*

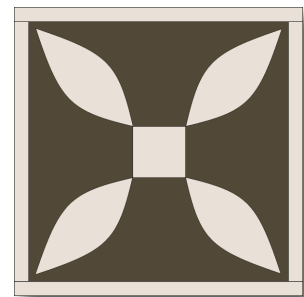

*Jane Stickle Colorway*

### Assembly:

1. Using the templates provided on page B12-2, appliqué the four melon units and one square unit to Unit C of the block. When all the units have been appliquéed to Unit C, trim the block to 5" x 5" square.
2. Join Unit B to the right side of the block, and then the left.
3. Join Unit A to the top of the block and then the bottom. Square up block to measure 5½" x 5½".

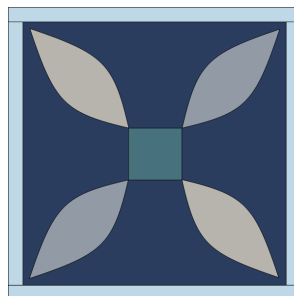

SET PRINTER TO "ACTUAL SIZE" WHEN PRINTING THIS PAGE.

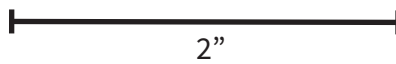
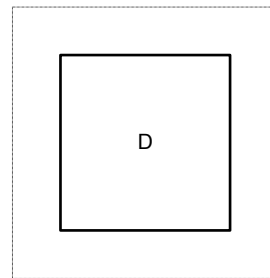
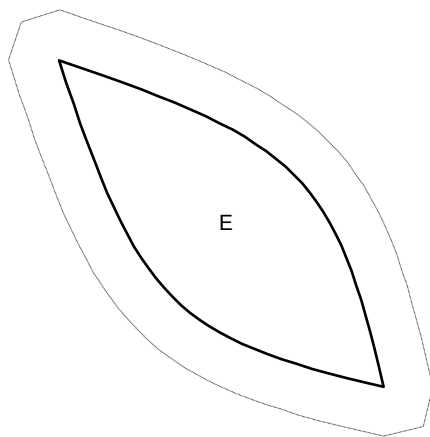

SET PRINTER TO "ACTUAL SIZE" WHEN PRINTING THIS PAGE.

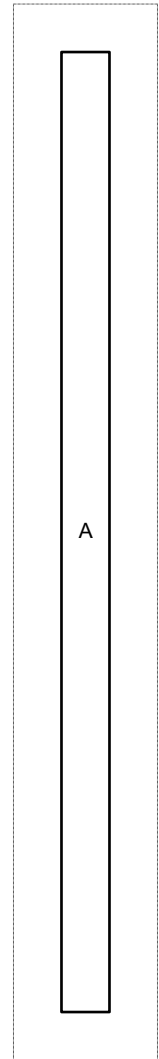
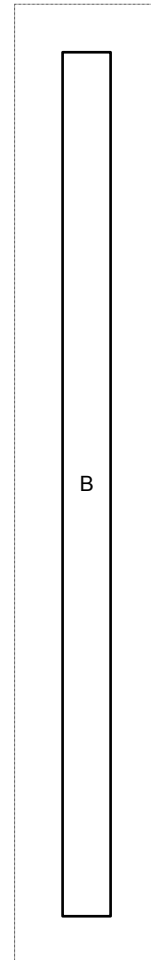
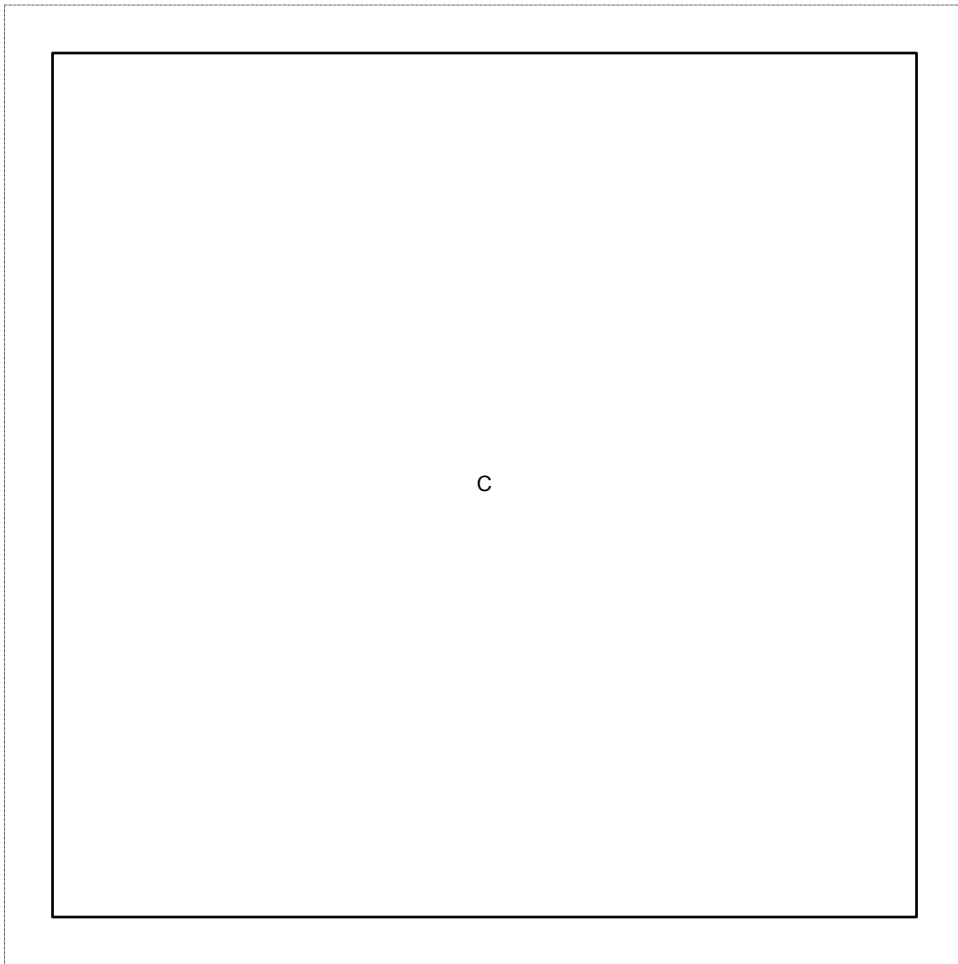
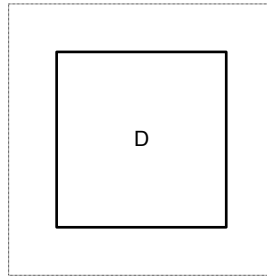
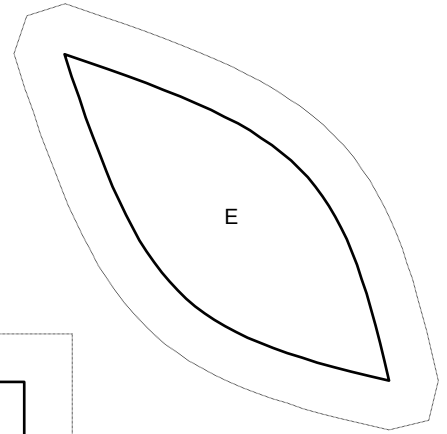
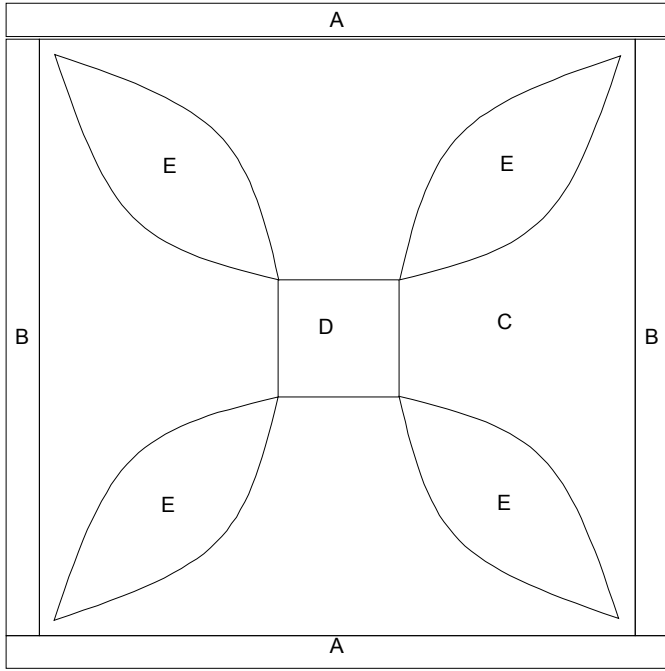

2"



## The Jane Stickle Quilt - Block B13

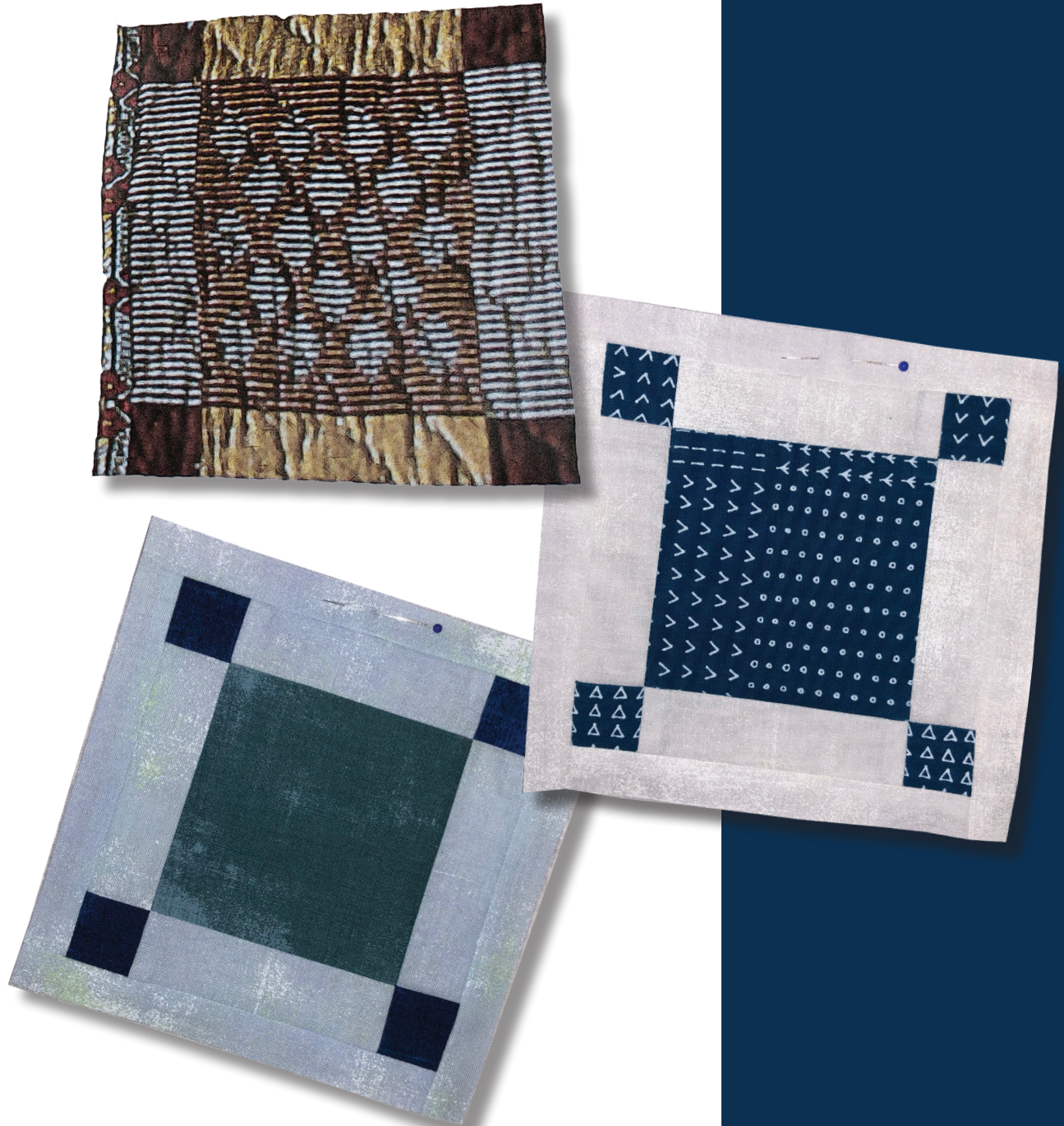

### What you need:

Patches	Quantity/size
A*	(2) 1" x 6"
B*	(2) 1" x 5"
C	(4) 1¼" x 1¼"
D	(4) 1¼" x 3½"
E	(1) 3½" x 3½"

*\*The actual required width for Unit A and Unit B units is ¾". The increased width specified above allows for squaring the block to exactly 5½".*

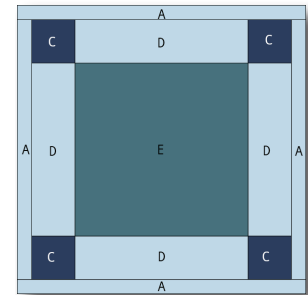

*Hobbystash Colorway*

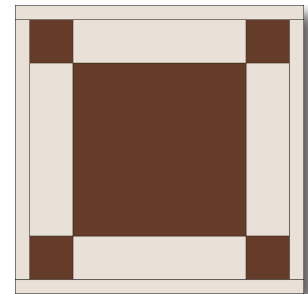

*Jane Stickle Colorway*

### Assembly:

1. Attach Unit C to opposite sides of Unit D as shown. Make two.

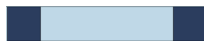

2. Attach remaining Unit D to each side of Unit E as shown.



3. Sew together rows from Step 1 and Step 2 as shown.



4. Join Unit B to the right side of the block, and then the left.

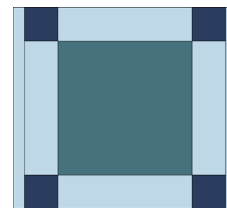

5. Join Unit A to the top of the block and then the bottom. Square up block to measure 5½" x 5½"

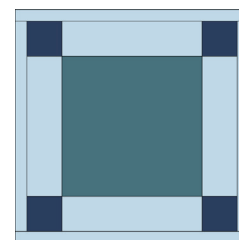



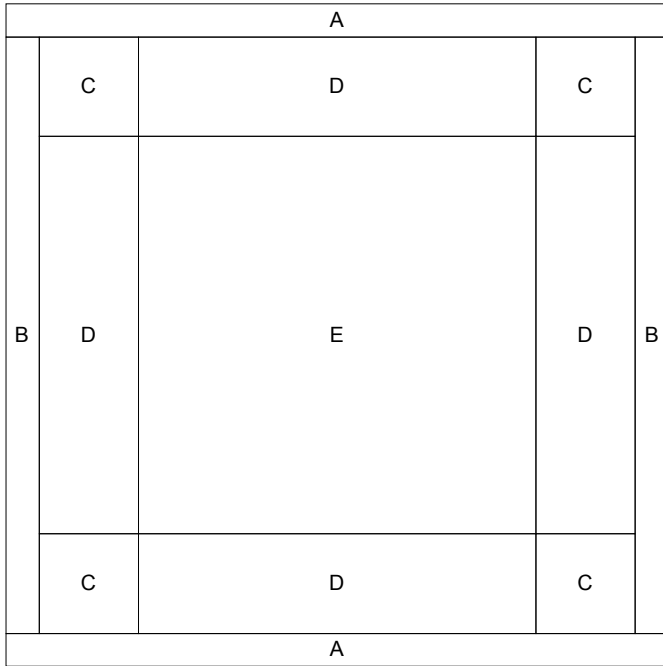

**SET PRINTER TO "ACTUAL SIZE" WHEN PRINTING THIS PAGE.**

