

The Jane Stickle Quilt - Row A

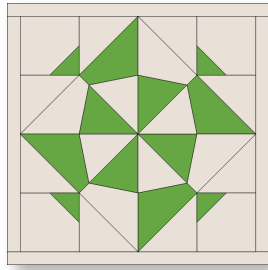

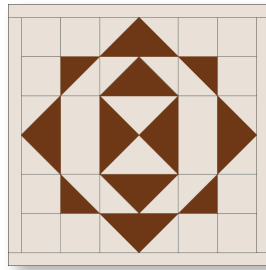

A1



A2

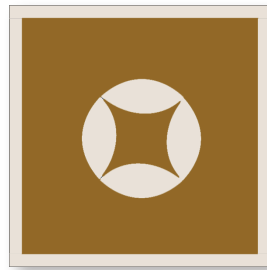

A3

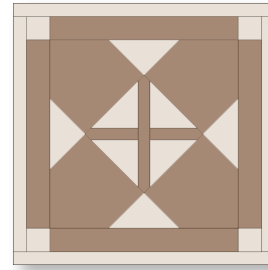

A4

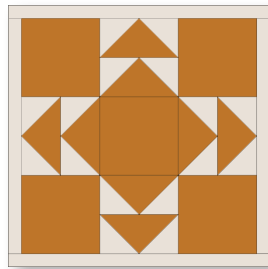

A5

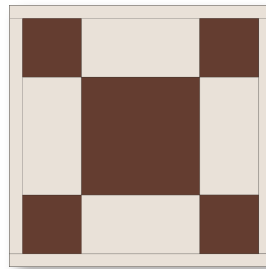

A6

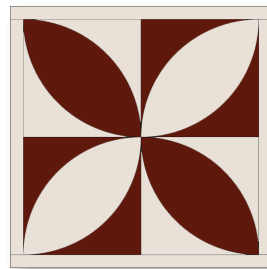

A7

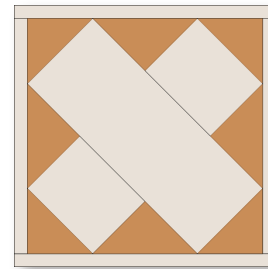

A8

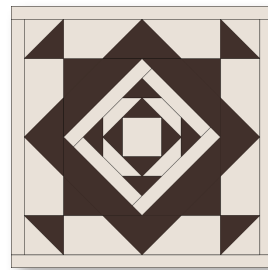

A9

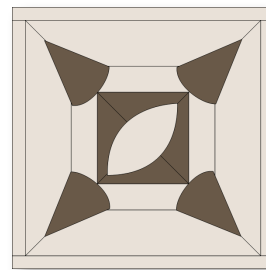

A10

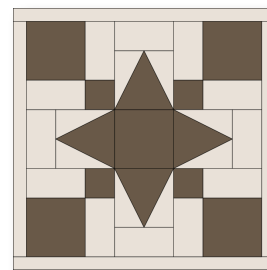

A11

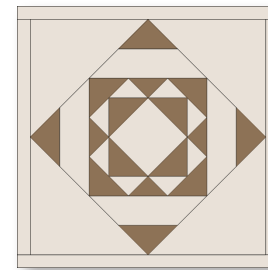

A12

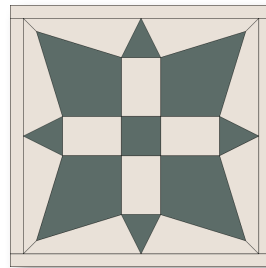

A13



The Jane Stickle Quilt - Block A1

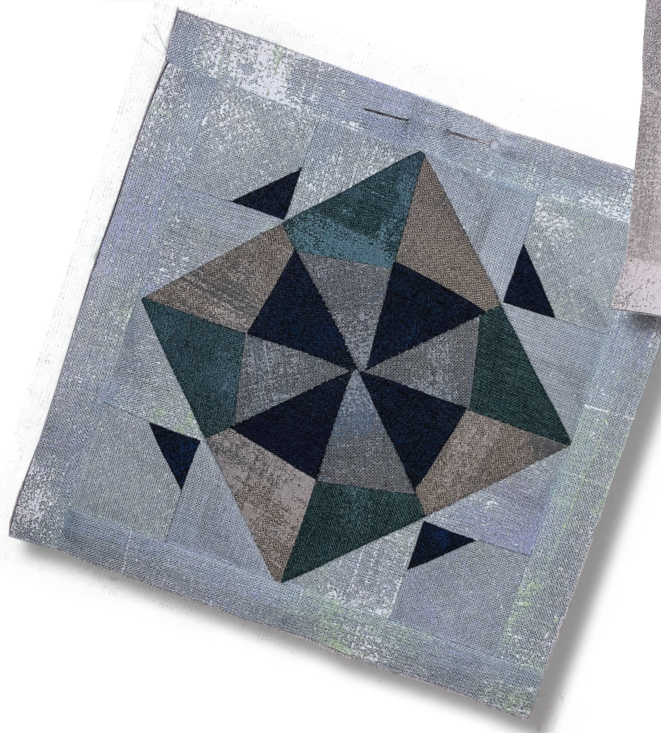

What you need:

Units	Quantity/size
A*	(2) 1" x 6"
B*	(2) 1" x 5"
C	(4) 2" x 2"
D	(8) 2" x 2"
E	(4) 2" x 3"
F	(4) 2" x 3"
G	(4) 2" x 2½"
H	(4) 2" x 2½"
I	(4) 1½" x 1½"

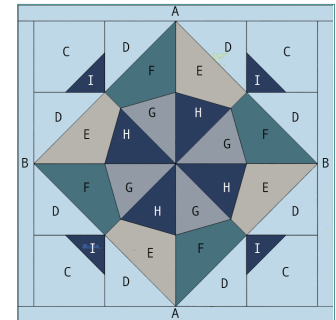

Hobbystash Colorway

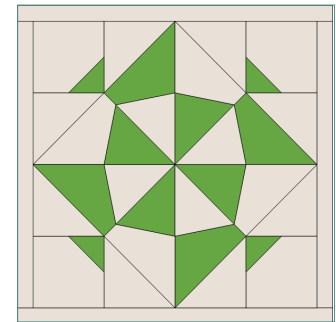

Jane Stickle Colorway

Assembly:

1. Use the templates provided on page A1-2, foundation piece the twelve sections of the block. Attach each fabric unit in the order numbered for each section. Join the sections as shown. The unfinished block should be 5" x 5" at this point.
2. Join Unit B to the right side of the block, and then the left.
3. Join Unit A to the top of the block and then the bottom. Square up block to measure 5½" x 5½" .

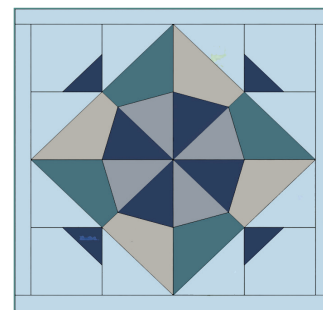
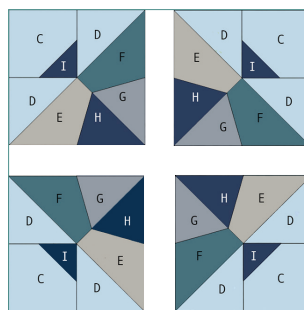
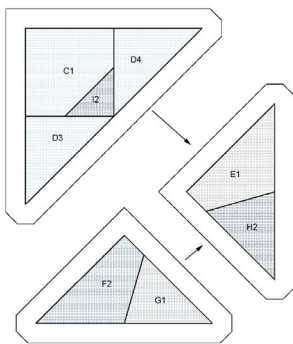

**The actual required width for Unit A and Unit B units is ¾". The increased width specified above allows for squaring the block to exactly 5½".*

SET PRINTER TO "ACTUAL SIZE" WHEN PRINTING THIS PAGE.

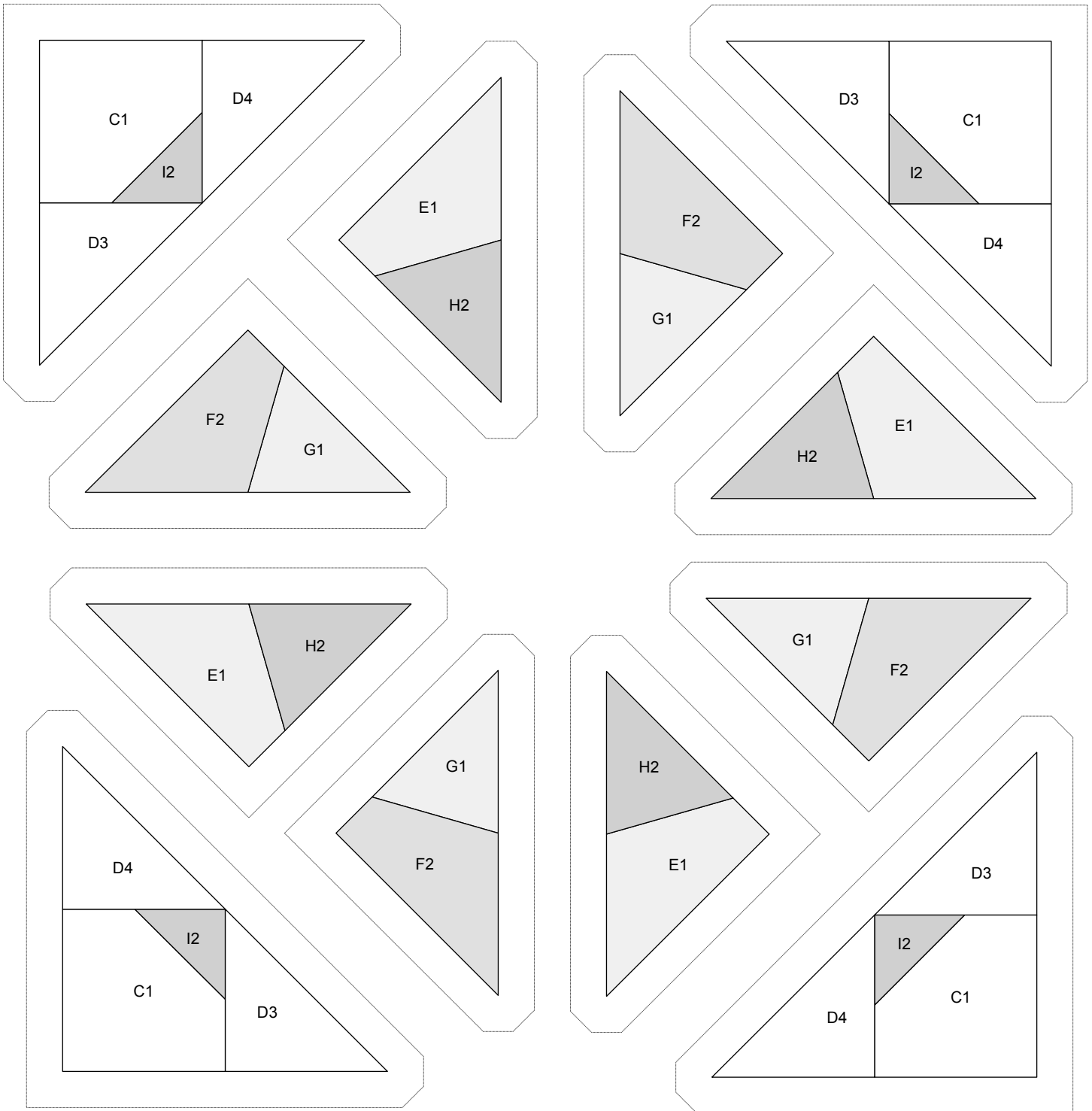

2"

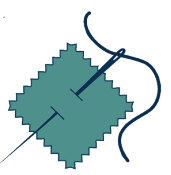

SET PRINTER TO "ACTUAL SIZE" WHEN PRINTING THIS PAGE.

Key Block (69/100 actual size)

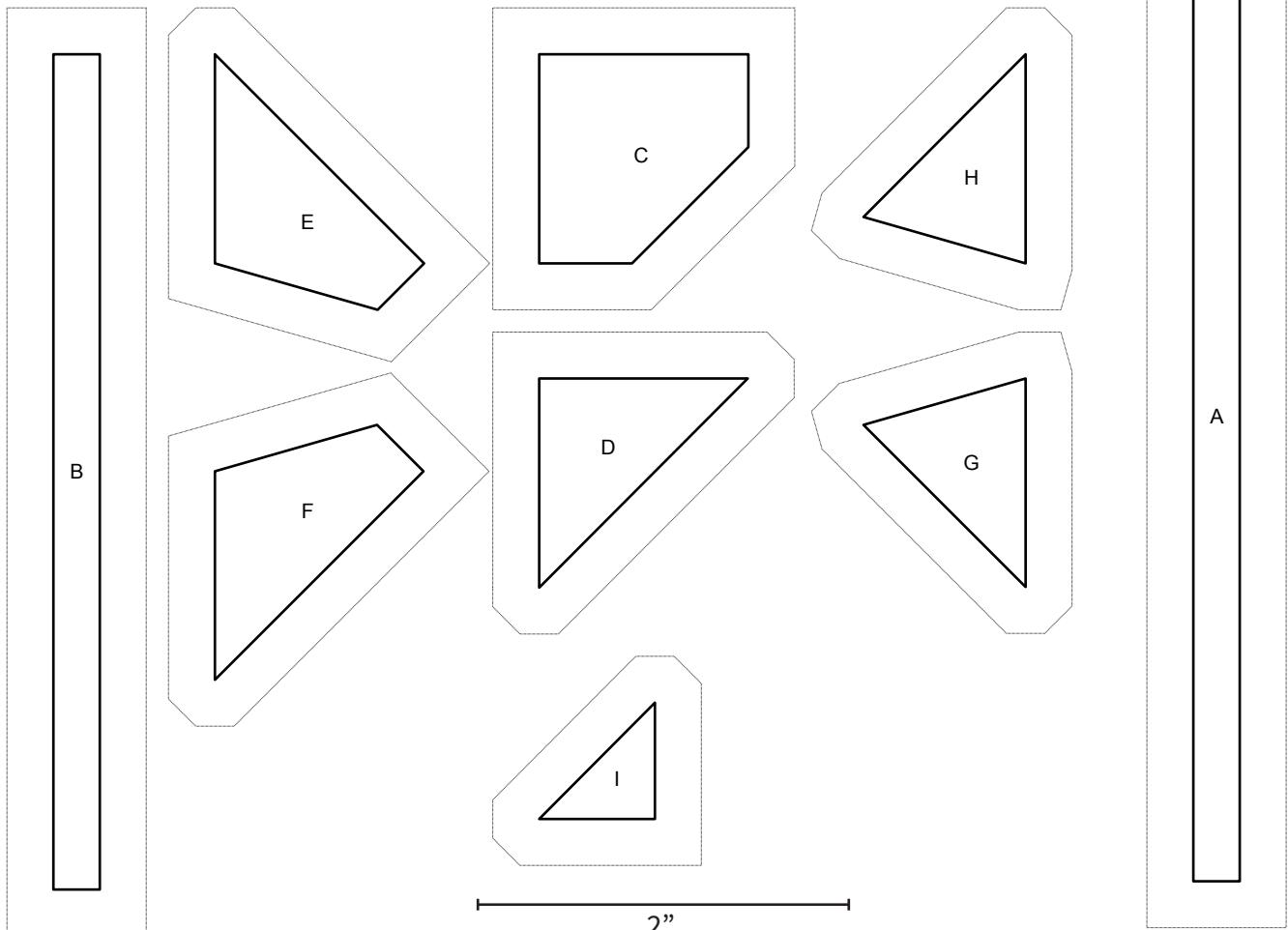
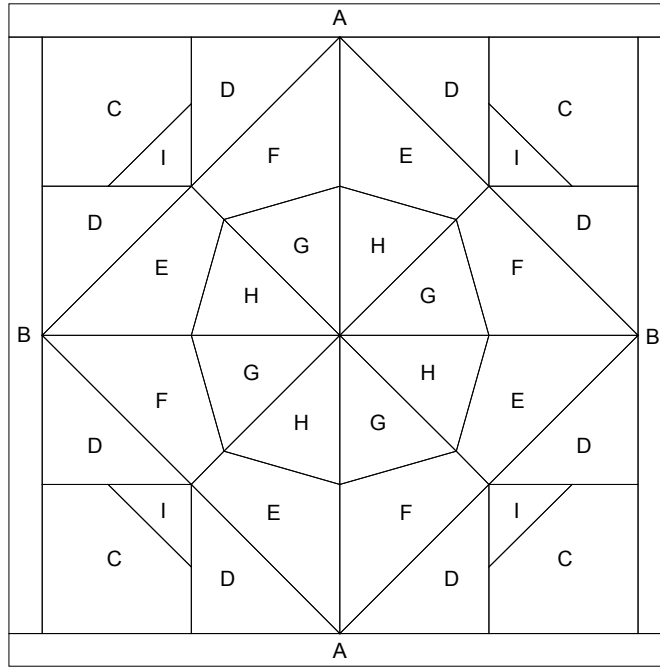

The Jane Stickle Quilt - Block A2



What you need:

Units	Quantity/size
A*	(2) 1" x 6"
B*	(2) 1" x 5"
C	(12) 1¼" x 1¼"
D	(2) 1⅝" x 1⅝" - green; (2) 1⅝" x 1⅝" - beige
E	(2) 1¼" x 2"
F	(6) 1¼" x 2" - navy; (2) 1¼" x 2" - green; (2) 1¼" x 2" - beige
G	(8) 1¼" x 1¼" - light blue; (4) 1¼" x 1¼" - beige

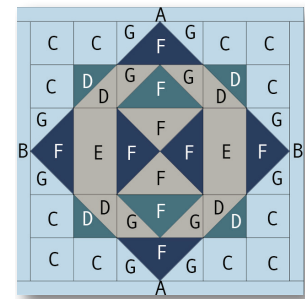

Hobbystash Colorway

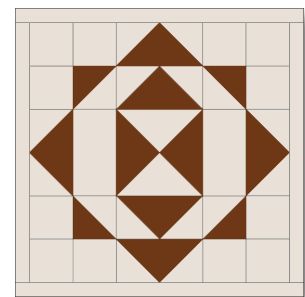

Jane Stickle Colorway

Assembly:

- Referring to BASIC INSTRUCTIONS for half-square triangles (HST) two at a time, layer a beige and a green Unit D. Make a total of four units. Arrange three Unit C and one Unit D HST to make a four patch. Make four.
- Referring to BASIC INSTRUCTIONS for stitch-and-flip flying geese, use two light blue Unit G with one navy Unit F to make each flying geese unit. Make a total of four light blue/navy flying geese units. Repeat the procedure with beige Unit G and green Unit F to make two beige/green flying geese units.
- Using block illustration as a color guide. Arrange two flying units (one of each color combination) and sew together as shown. Make two.
- Arrange units from Step 1 and Step 3 as shown. Sew together. Make two.
- For the middle section of the block, sew light blue/navy flying geese unit to a Unit E. Make two.
- Using the templates provided on Page A2-2, foundation piece Unit F quarter square triangle unit.
- Arrange units from Step 5 and Step 6 and sew together.
- Arrange units from Step 4 and Step 7 and sew together.
- Join Unit B to the right side of the block, and then the left.
- Join Unit A to the top of the block and then the bottom. Square up block to measure 5½" x 5½" .

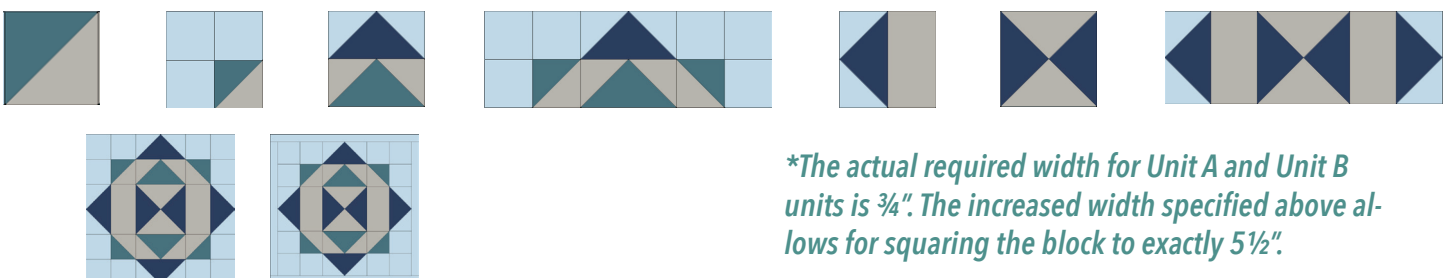

**The actual required width for Unit A and Unit B units is ¾". The increased width specified above allows for squaring the block to exactly 5½".*

SET PRINTER TO "ACTUAL SIZE" WHEN PRINTING THIS PAGE.

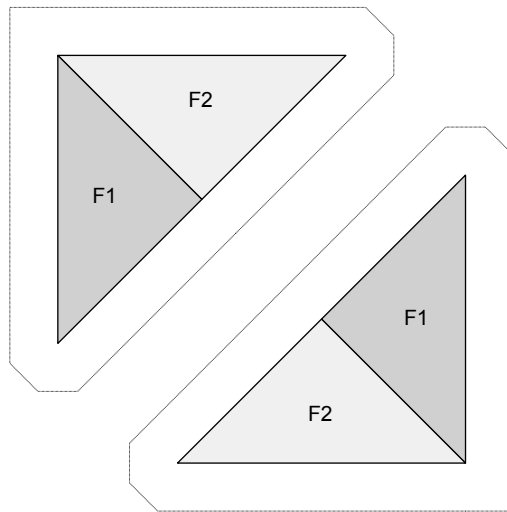

2"

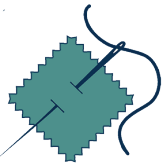

SET PRINTER TO "ACTUAL SIZE" WHEN PRINTING THIS PAGE.

Key Block (69/100 actual size)

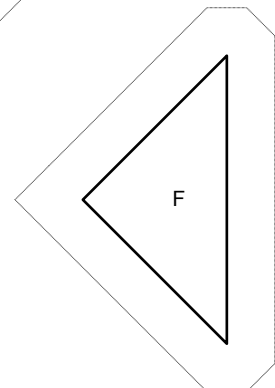
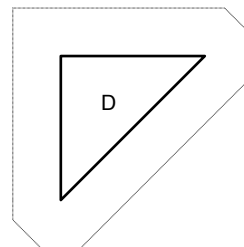
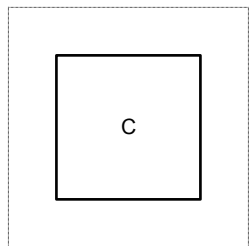
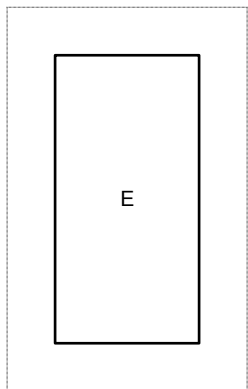
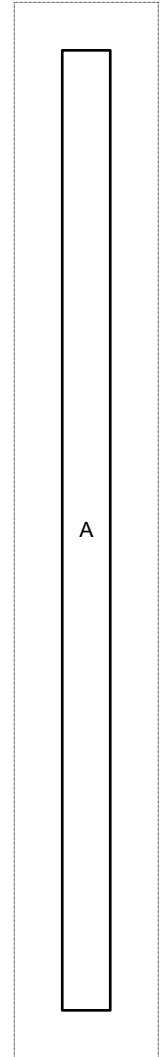
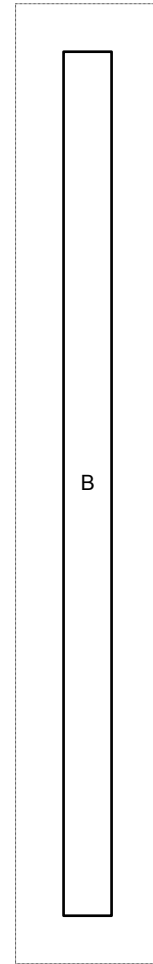
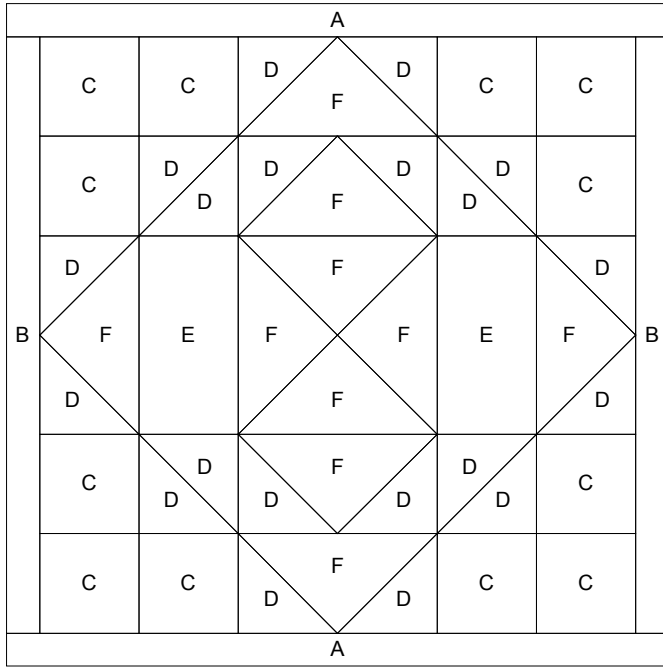

I

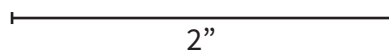

The Jane Stickle Quilt - Block A3



What you need:

Patches	Quantity/size
A*	(2) 1" x 6"
B*	(2) 1" x 5"
C	(1) 6" x 6"
D	(4) 2" x 4"

**The actual required width for Unit A and Unit B units is ¾". The increased width specified above allows for squaring the block to exactly 5½".*

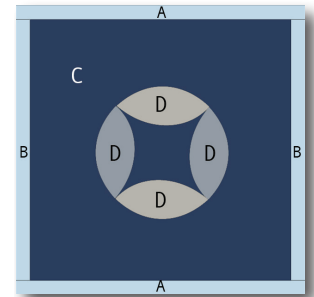

Hobbystash Colorway

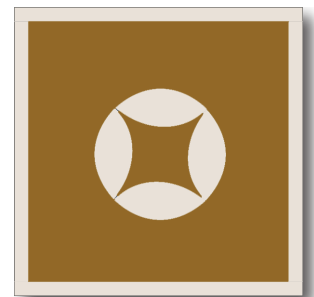

Jane Stickle Colorway

Assembly:

1. Using the templates provided on page A3-2, appliqué the four leaf units to Unit A of the block. When all the leaves have been appliquéd to Square A, trim the block to 5" x 5" square.
2. Join Unit B to the right side of the block, and then the left.
3. Join Unit A to the top of the block and then the bottom. Square up block to measure 5½" x 5½".

Note: Templates for Curved Piecing in lieu of Appliqué have been provided on Page A3-4.

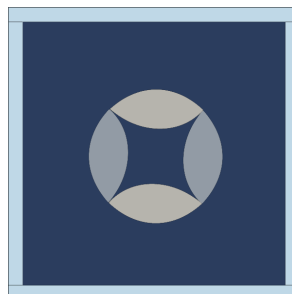

SET PRINTER TO "ACTUAL SIZE" WHEN PRINTING THIS PAGE.

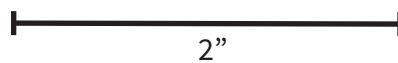
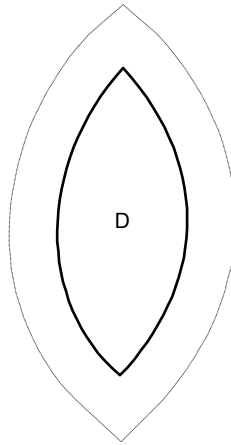

Based on the photo of the original block, it appears this block was actually curved pieced rather than appliquéd. Below are the templates for curved piecing if you wish to remain true to the original quilt.

SET PRINTER TO "ACTUAL SIZE" WHEN PRINTING THIS PAGE.

Key Block (69/100 actual size)

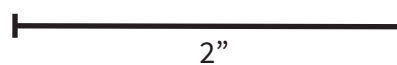
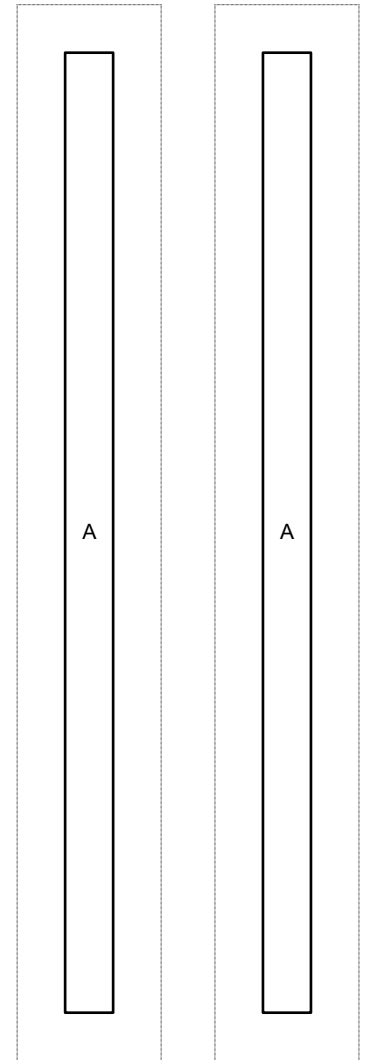
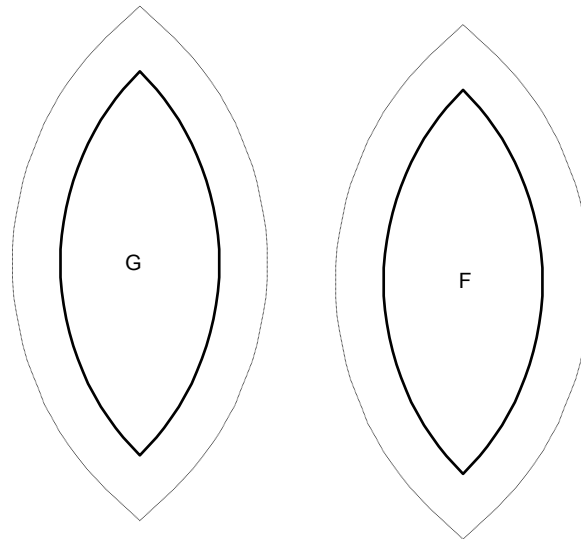
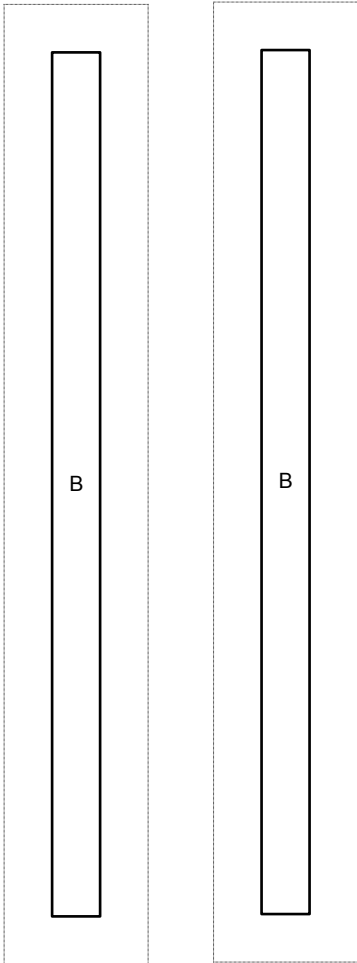
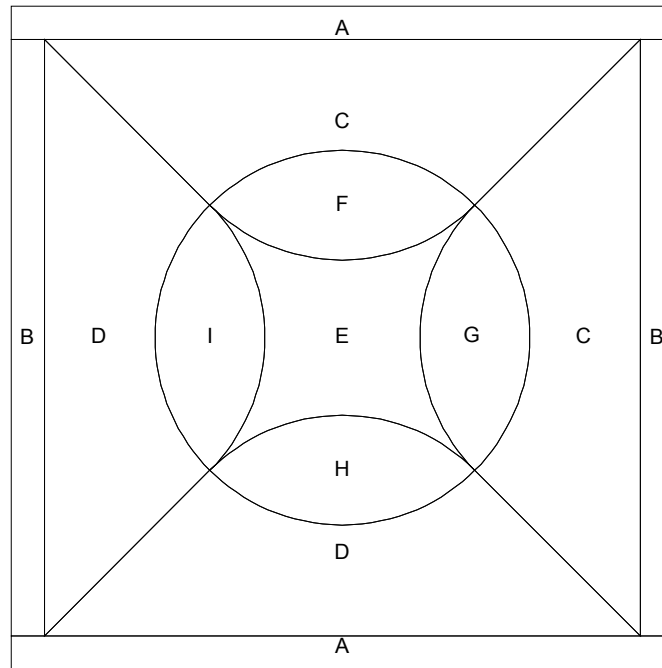

SET PRINTER TO "ACTUAL SIZE" WHEN PRINTING THIS PAGE.

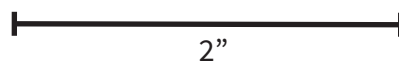
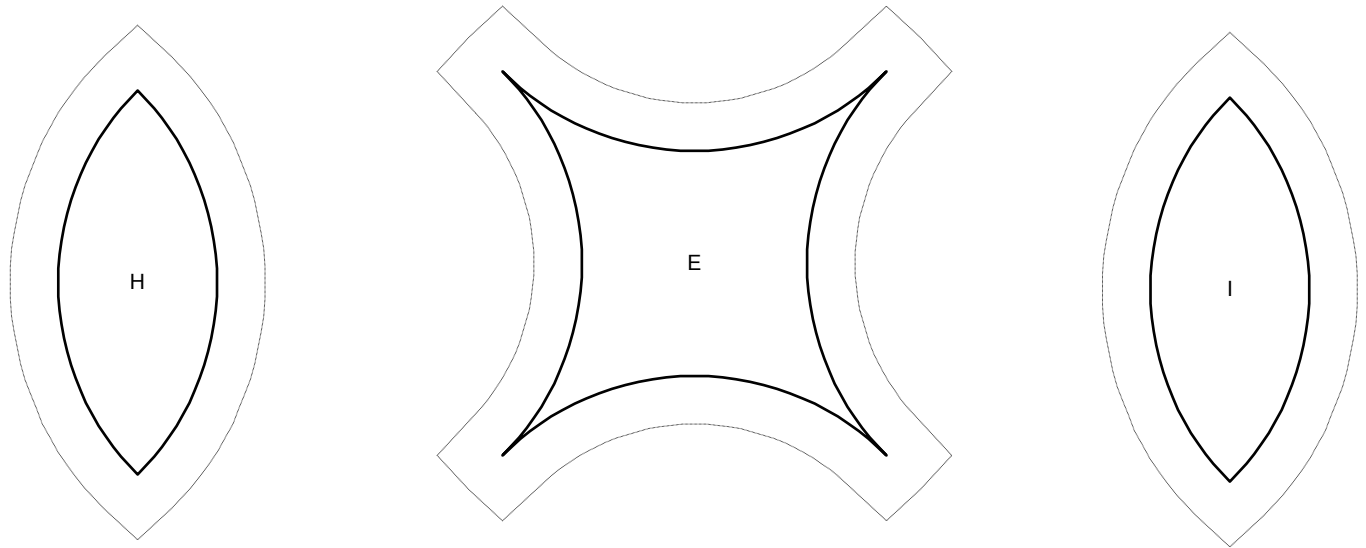
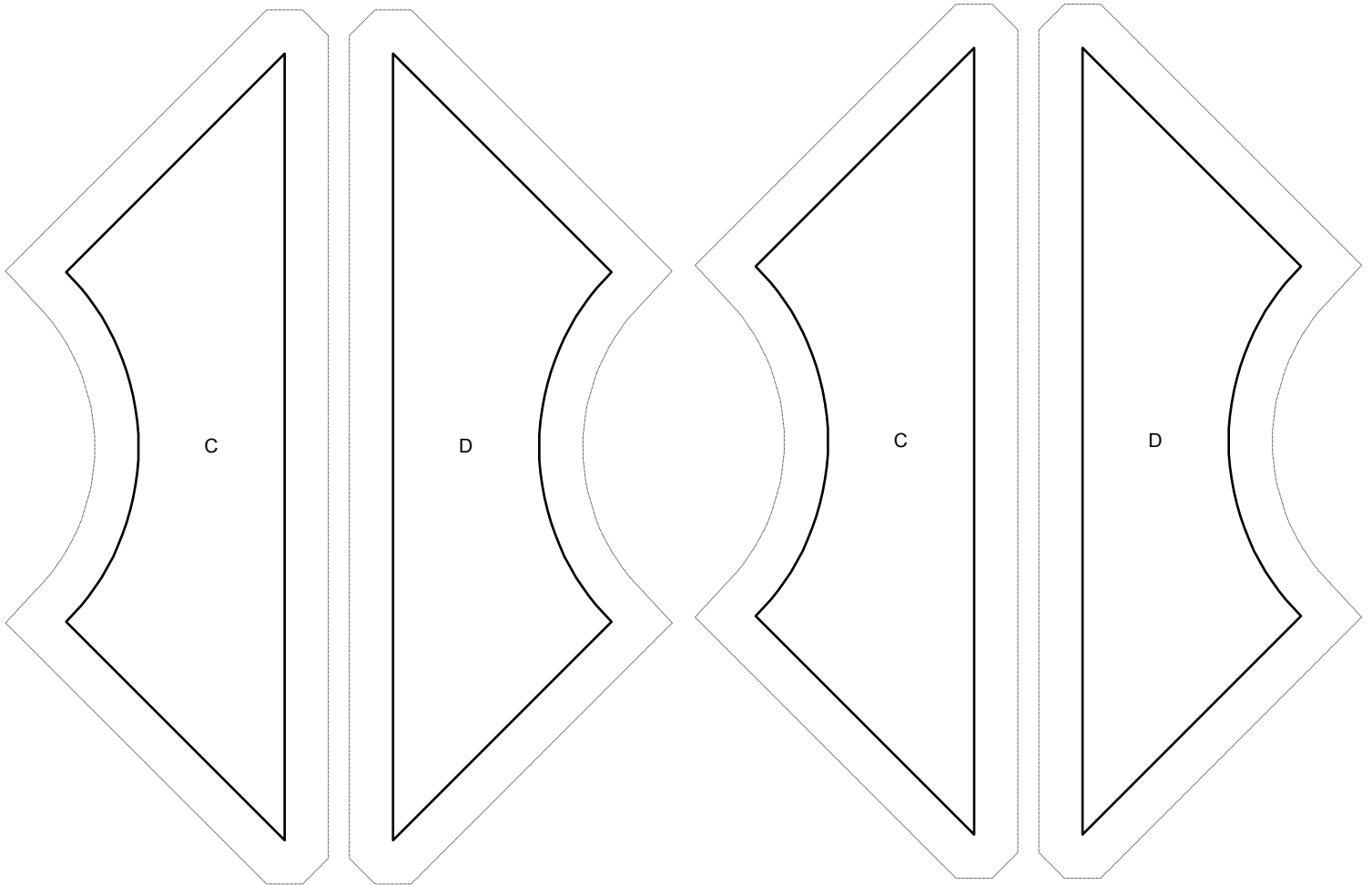

The Jane Stickle Quilt - Block A4



What you need:

Units	Quantity/size
A*	(2) 1" x 6"
B*	(2) 1" x 5"
C	(4) 1" x 1"
D	(4) 1" x 4½"
E	(4) 3" x 3"
F	(4) 2½" x 2½"
G	(2) 1" x 2"
H	(4) 2" x 2"
I	(1) 1" x 3"

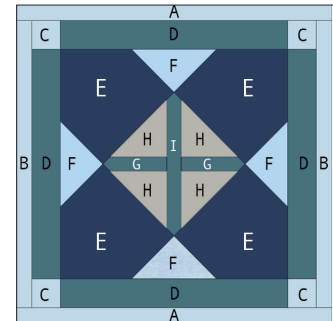

Hobbystash Colorway

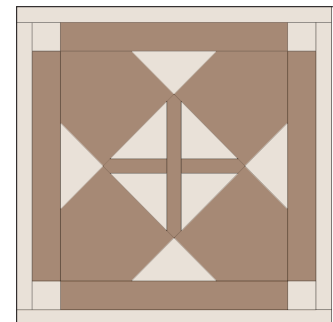

Jane Stickle Colorway

**The actual required width for Unit A and Unit B units is ¾". The increased width specified above allows for squaring the block to exactly 5½".*

Assembly:

1. Use the templates provided on Page A4-2 to foundation piece the sections of the block. Attach each fabric unit in the order numbered for each section. Join the sections, using the below images for reference. The unfinished block should be 5" x 5" at this point.
2. Join Unit B to the right side of the block, and then the left.
3. Join Unit A to the top of the block and then the bottom. Square up block to measure 5½" x 5½".

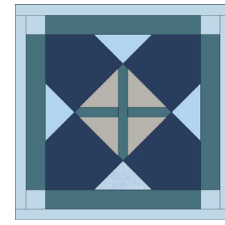
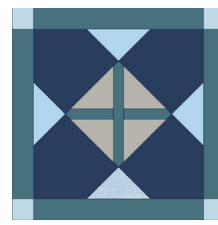

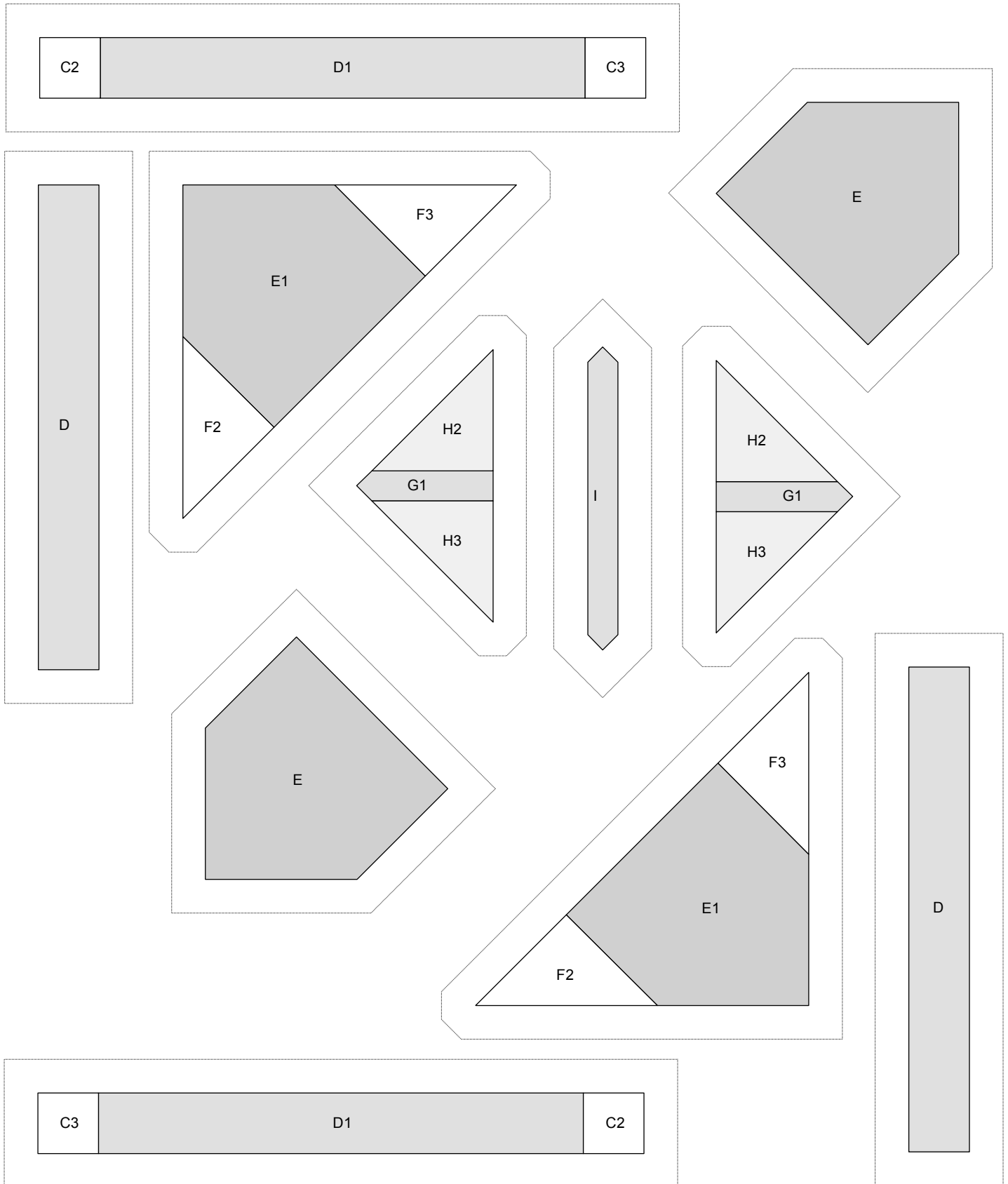

2"

SET PRINTER TO "ACTUAL SIZE" WHEN PRINTING THIS PAGE.

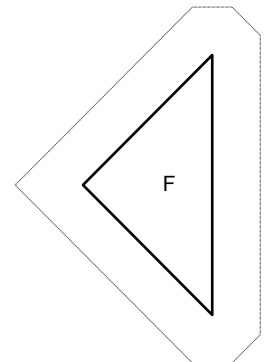
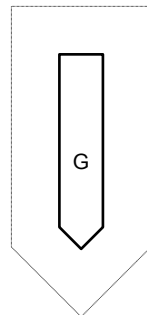
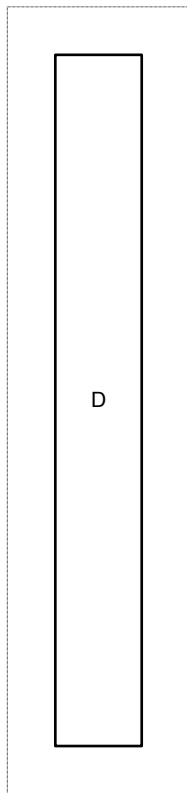
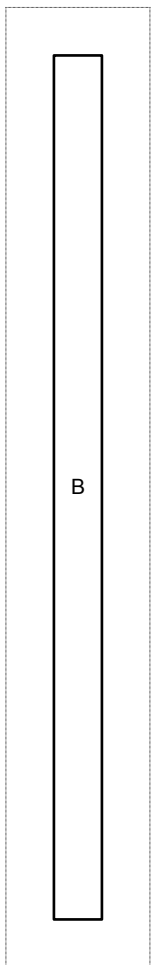
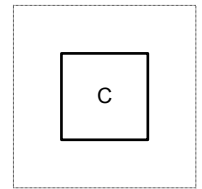
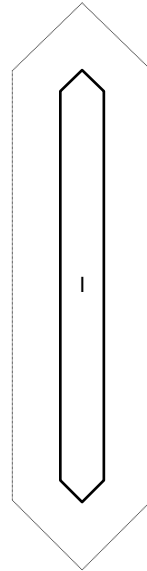
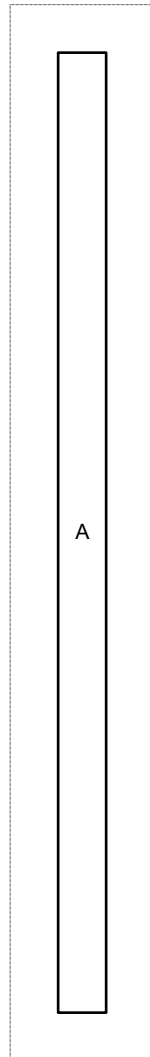
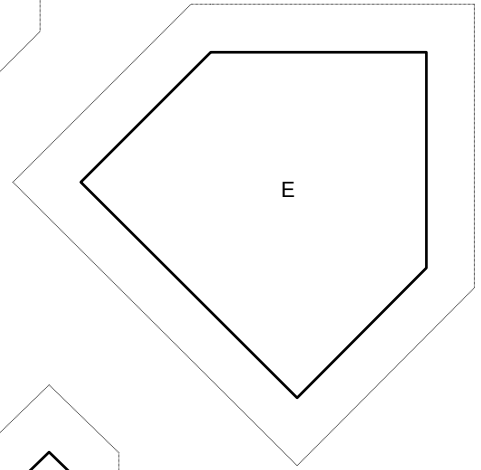
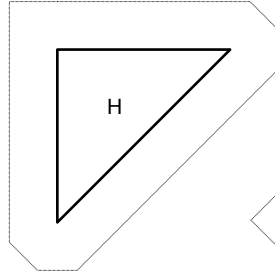
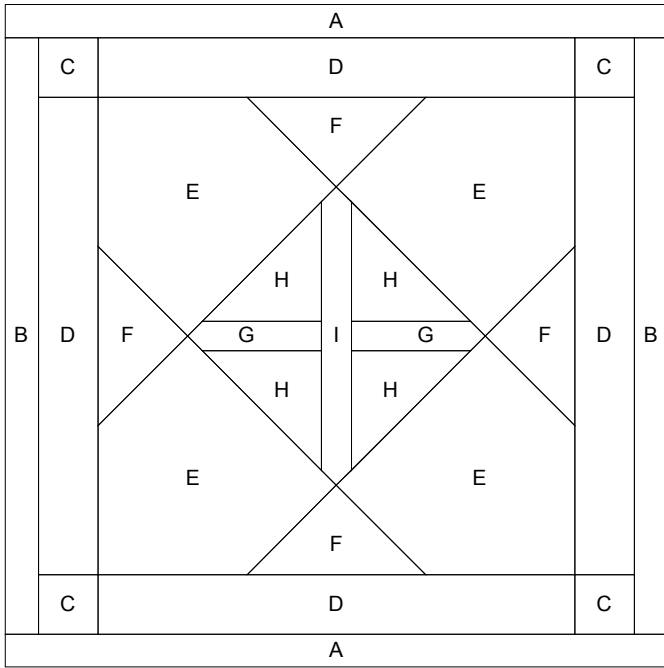

2"

The Jane Stickle Quilt - Block A5



What you need:

Patches	Quantity/size
A*	(2) 1" x 6"
B*	(2) 1" x 5"
C	5 squares 2" x 2"
D	8 squares 1¼" x 1¼" (light blue) 8 squares 1¼" x 1¼" (beige)
E	4 rectangles 1¼" x 2" (navy) 4 rectangles 1¼" x 2" (green)

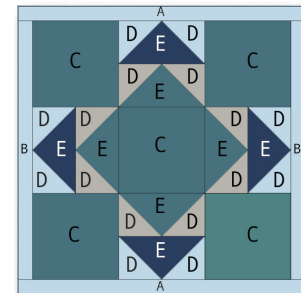

Hobbystash Colorway

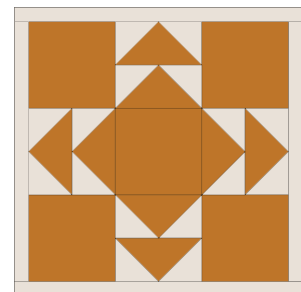

Jane Stickle Colorway

*The actual required width for Unit A and Unit B units is ¾". The increased width specified above allows for squaring the block to exactly 5½".

Assembly:

- Referring to BASIC INSTRUCTIONS for stitch-and-flip flying geese, layer two light blue Unit D with one navy Unit E using the stitch and flip method. Make four.
- Repeat procedure using beige Unit D and green Unit E. Make four.
- Arrange flying geese units from Step 1 and Step 2. Sew together as shown. Make four.
- Join a Unit C to each side of a flying geese block from Step 3 as shown. Make two.

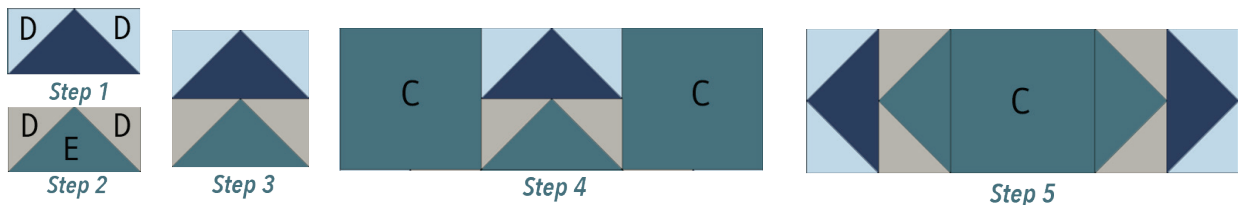

- Join the two remaining flying geese units from Step 3 to the sides of the remaining Unit C as shown.
- Join the rows from Step 4 and Step 5 as shown.
- Join Unit B to the right side of the block, and then the left.
- Join Unit A to the top of the block and then the bottom. Square up block to measure 5½" x 5½".

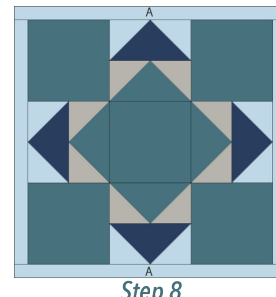
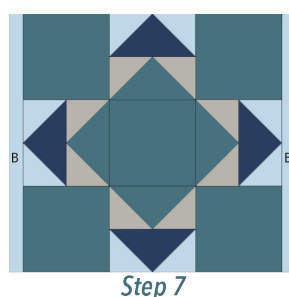
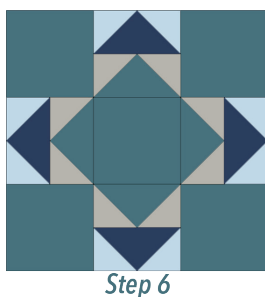

SET PRINTER TO "ACTUAL SIZE" WHEN PRINTING THIS PAGE.

Key Block (69/100 actual size)

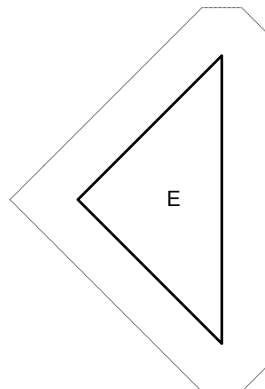
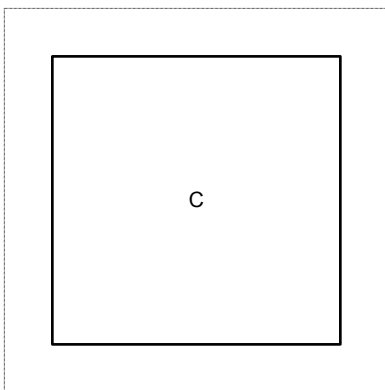
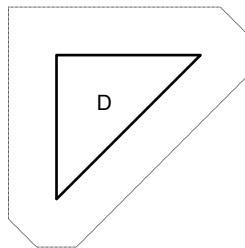
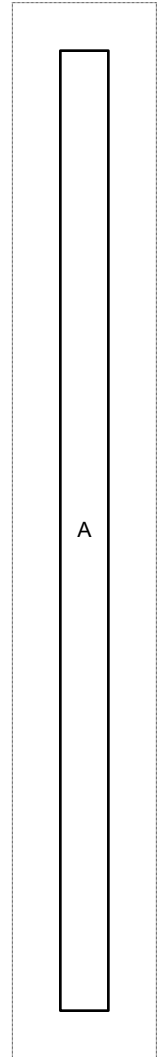
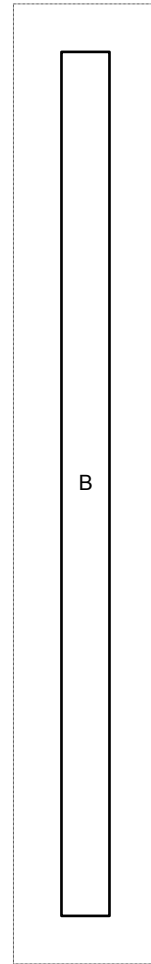
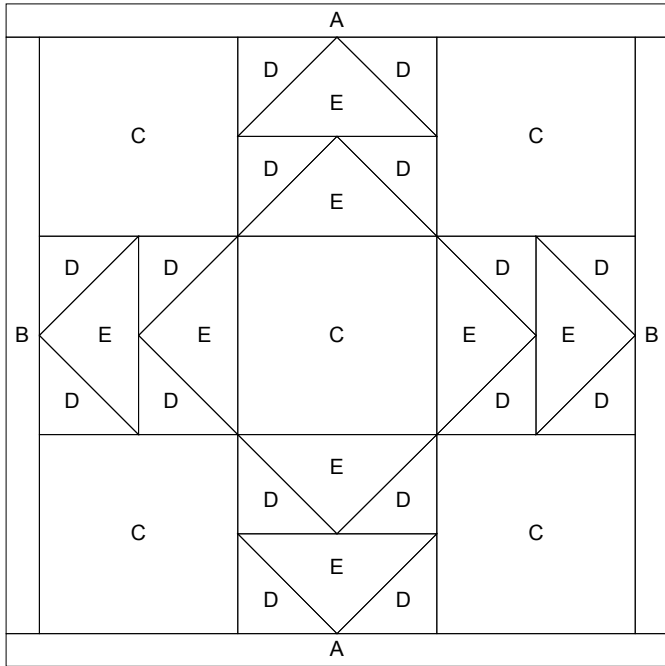

2"

The Jane Stickle Quilt - Block A6



What you need:

Patches	Quantity/size
A*	(2) 1" x 6"
B*	(2) 1" x 5"
C	4 squares 1⅝" x 1⅝"
D	4 rectangles 1⅝" x 2¾"
E	1 square 2¾" x 2¾"

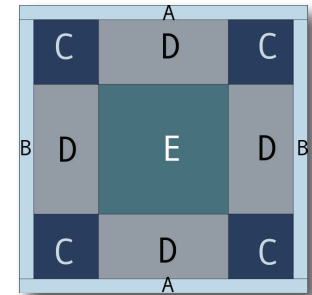

Hobbystash Colorway

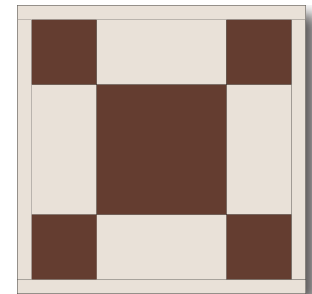

Jane Stickle Colorway

**The actual required width for Unit A and Unit B units is ¾". The increased width specified above allows for squaring the block to exactly 5½".*

Assembly:

1. Attach Unit C to opposite sides of Unit D as shown. Make two.



2. Attach remaining Unit D to each side of Unit E as shown.

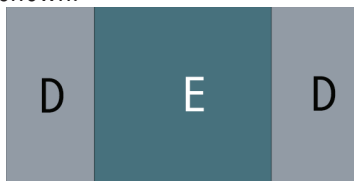

3. Sew together rows from Step 1 and Step 2 as shown.

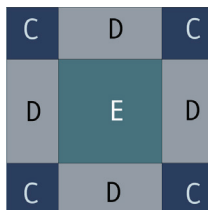

4. Join Unit B to the right side of the block, and then the left.

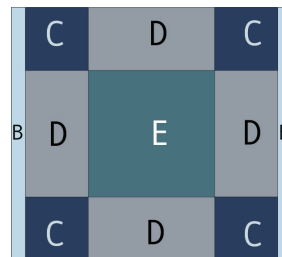

5. Join Unit A to the top of the block and then the bottom. Square up block to measure 5½" x 5½"

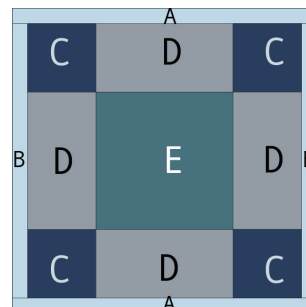

SET PRINTER TO "ACTUAL SIZE" WHEN PRINTING THIS PAGE.

Key Block (69/100 actual size)

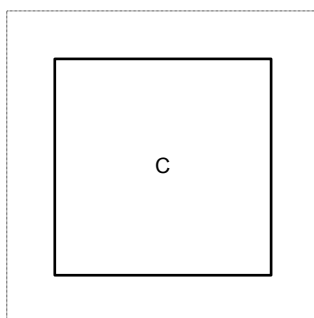
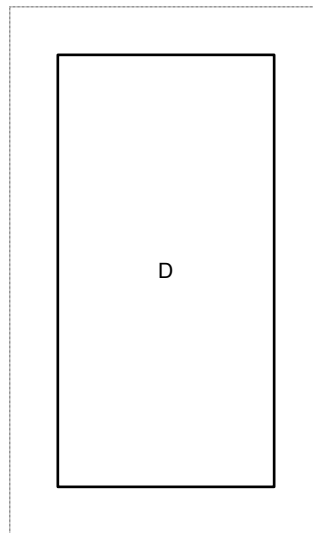
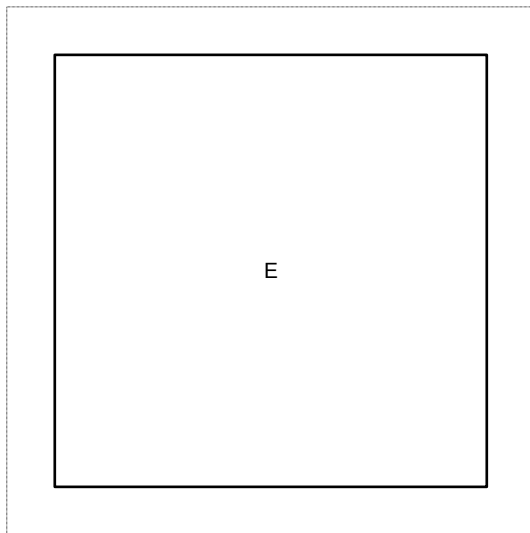
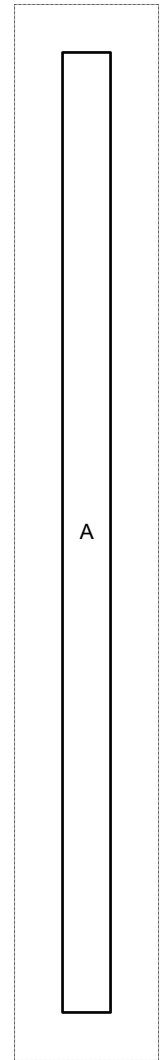
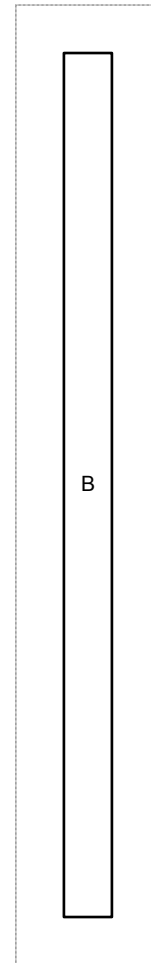
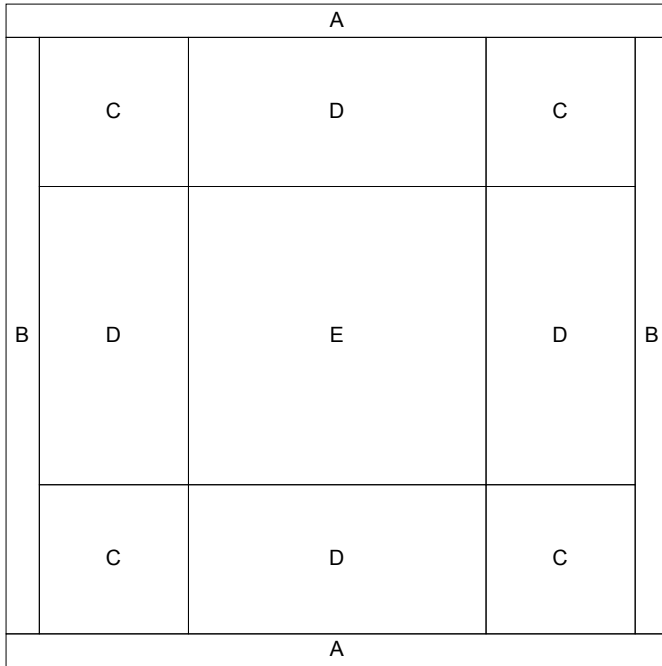

2"

The Jane Stickle Quilt - Block A7



What you need:

Patches	Quantity/size
A*	(2) 1" x 6"
B*	(2) 1" x 5"
C	2 squares 3" x 3"
D	2 square 3" x 3"
E	2 rectangles 3" x 4"
F	2 rectangles 3" x 4"

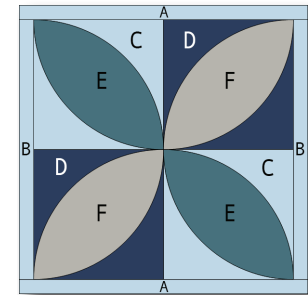

Hobby Stash Colorway

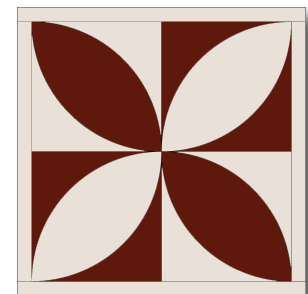

Jane Stickle Colorway

**The actual required width for Unit A and Unit B units is ¾". The increased width specified above allows for squaring the block to exactly 5½".*

Assembly:

1. Assemble four-patch block using two Unit C and two Unit D squares as shown.

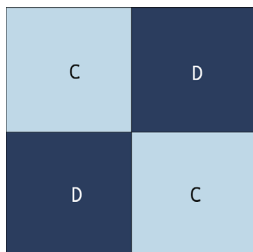

2. Using the templates provided on Page A7-2, appliqué two Unit E and two Unit F to the four-patch. Trim block to 5" x 5" square.

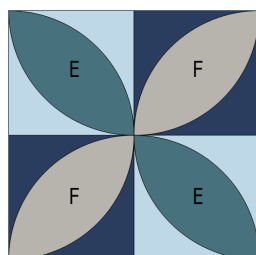

3. Join Unit B to the right side of the block, and then the left.

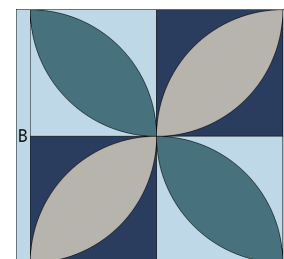

4. Join Unit A to the top of the block and then the bottom. Square up block to measure 5½" x 5½"

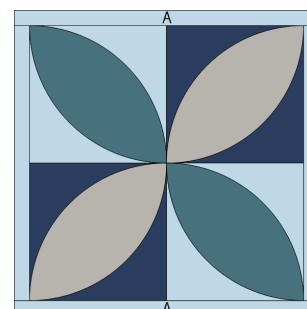

SET PRINTER TO "ACTUAL SIZE" WHEN PRINTING THIS PAGE.

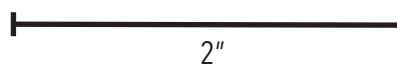
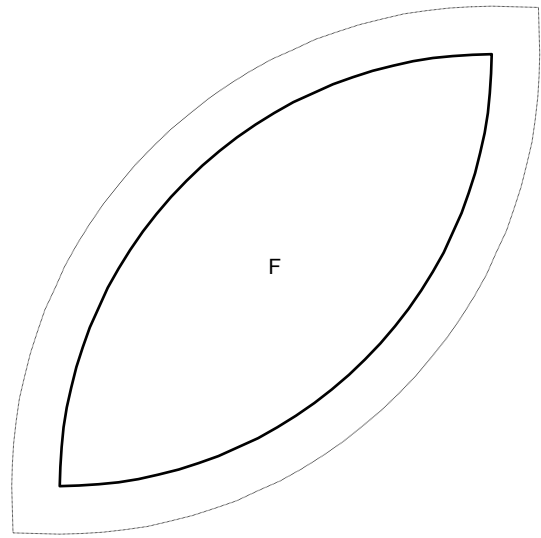
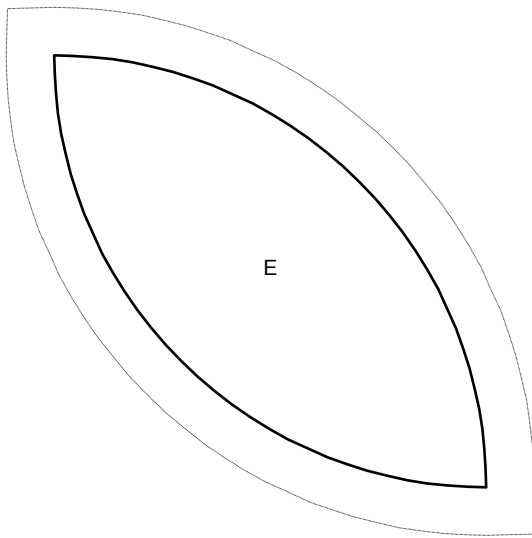
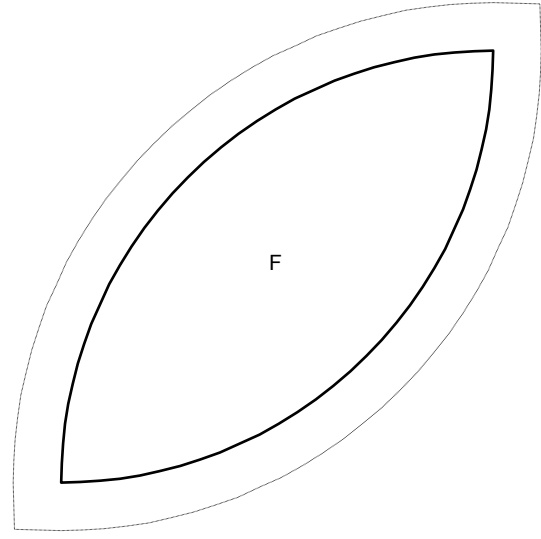
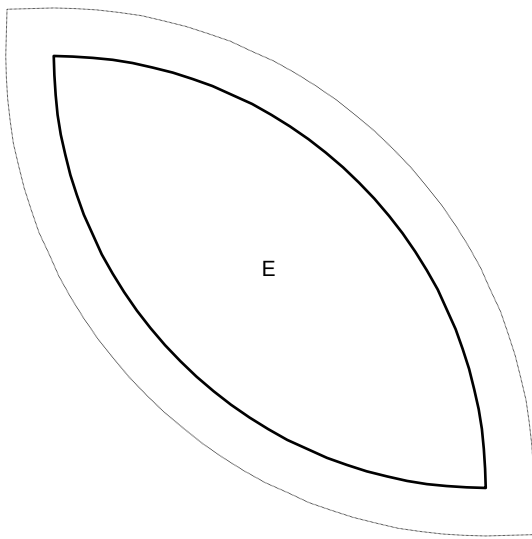

Key Block (69/100 actual size)

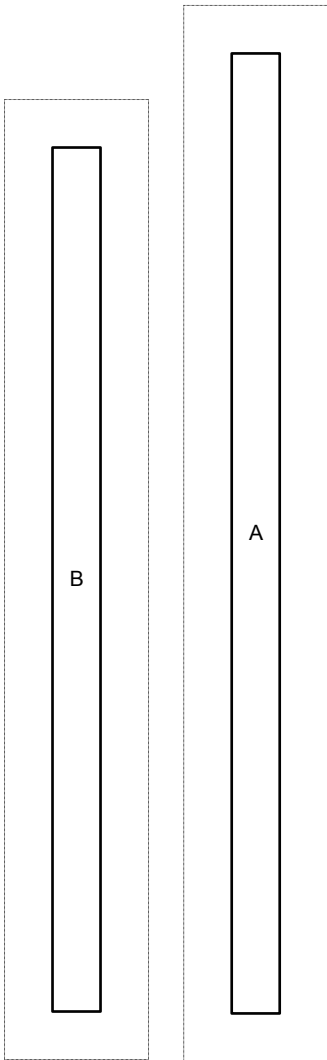
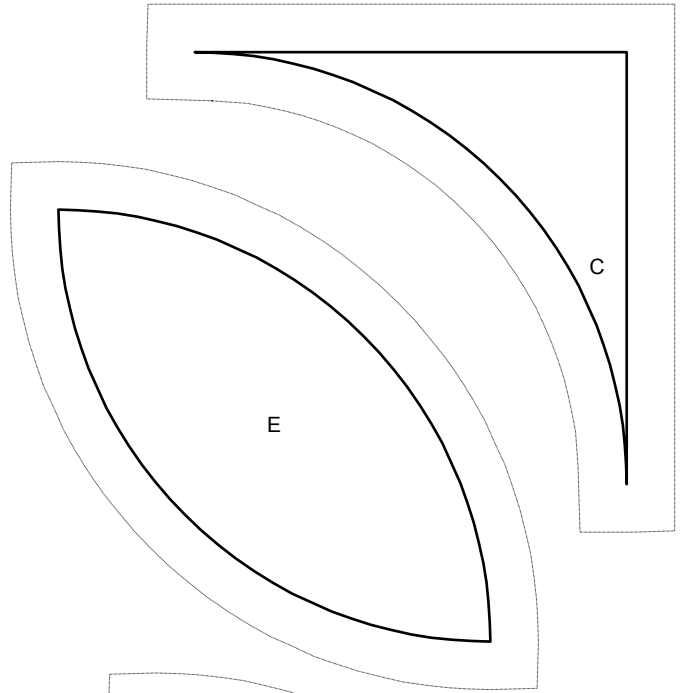
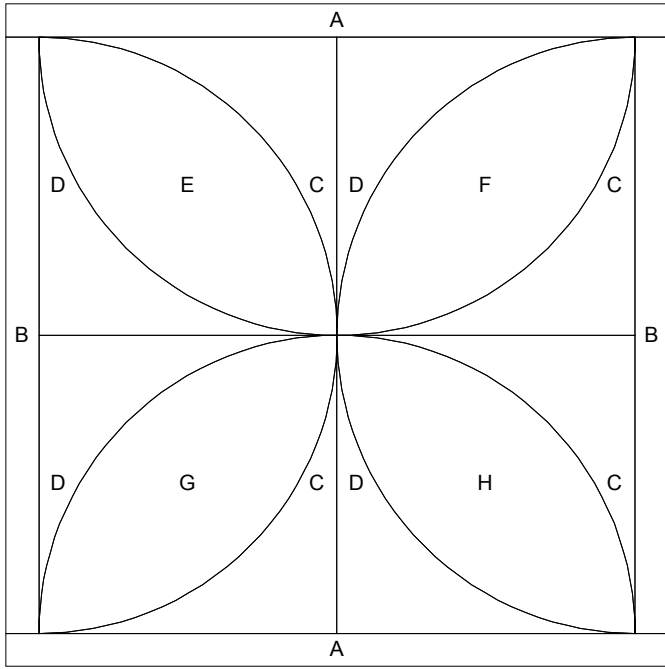

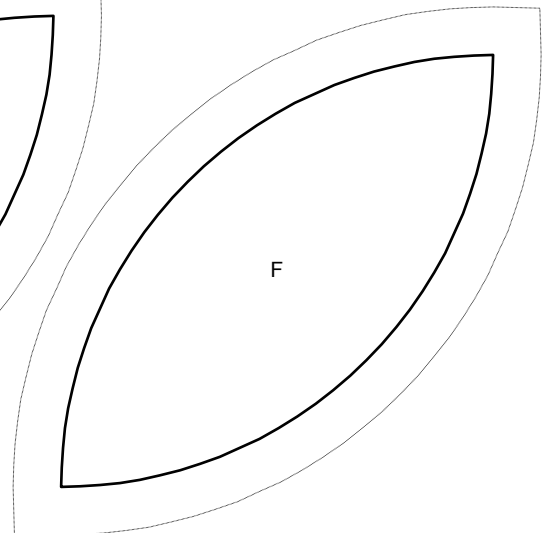
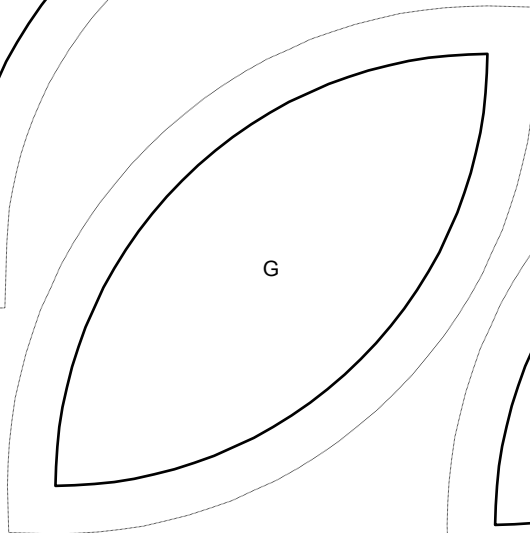
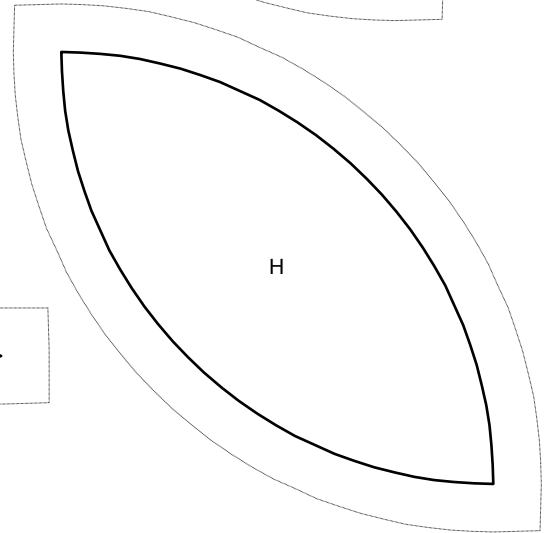
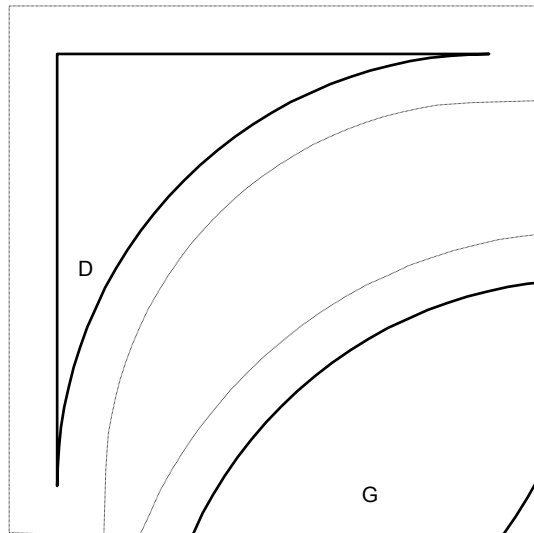

2"



The Jane Stickle Quilt - Block A8



What you need:

Patches	Quantity/size
A*	(2) 1" x 6"
B*	(2) 1" x 5"
C	2 squares 3" x 3", cut once diagonally (halved) 
D	1 square 4" x 4", cut twice diagonally (quartered) 
E	1 rectangle 3" x 6"
F	2 rectangles 2" x 3"

*The actual required width for Unit A and Unit B units is ¾". The increased width specified above allows for squaring the block to exactly 5½".

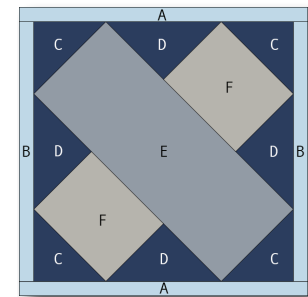

Hobbystash Colorway

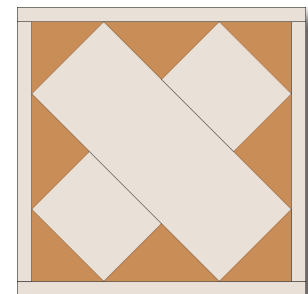

Jane Stickle Colorway

Assembly:

- Using the templates provided on Page A8-2, create the three foundation sections.
- Join the sections together.
- Join Unit B to the right side of the block, and then the left.
- Join Unit A to the top of the block and then the bottom. Square up block to measure 5½" x 5½"

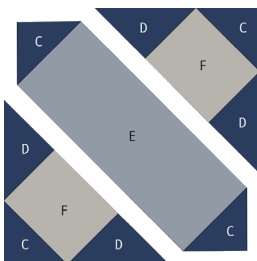

Step 1

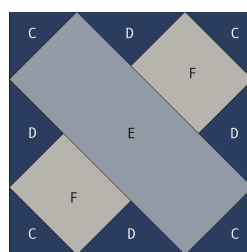

Step 2

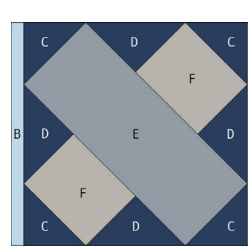

Step 3

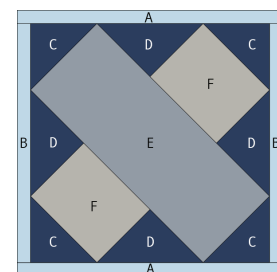

Step 4

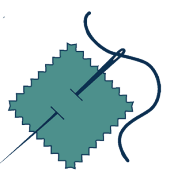

SET PRINTER TO "ACTUAL SIZE" WHEN PRINTING THIS PAGE.

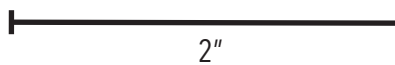
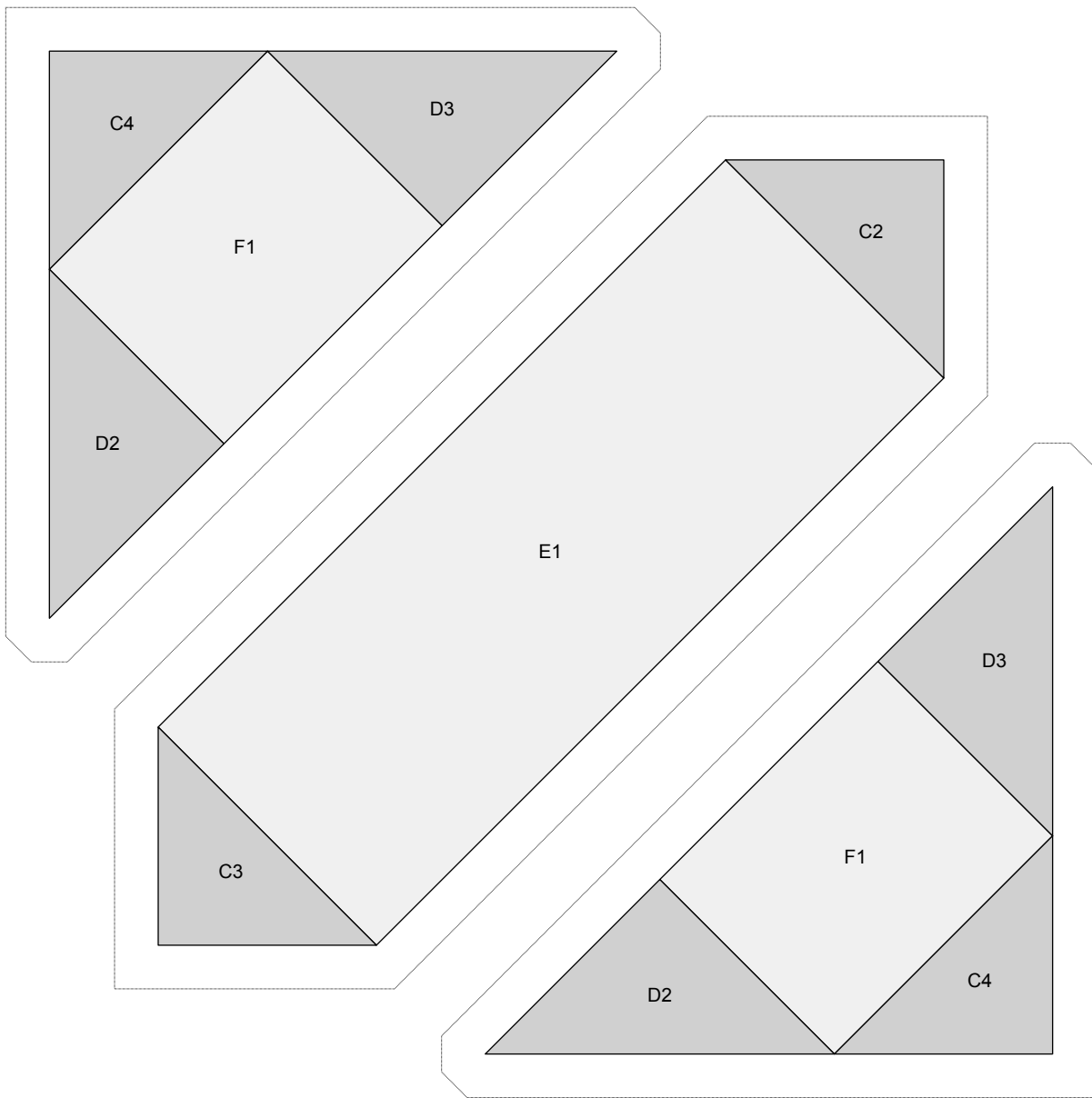

SET PRINTER TO "ACTUAL SIZE" WHEN PRINTING THIS PAGE.

Key Block (69/100 actual size)

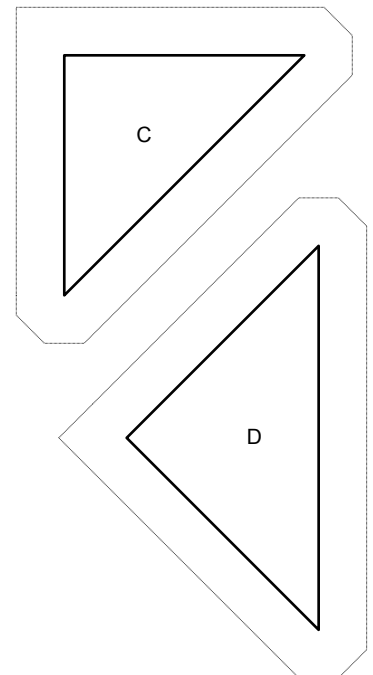
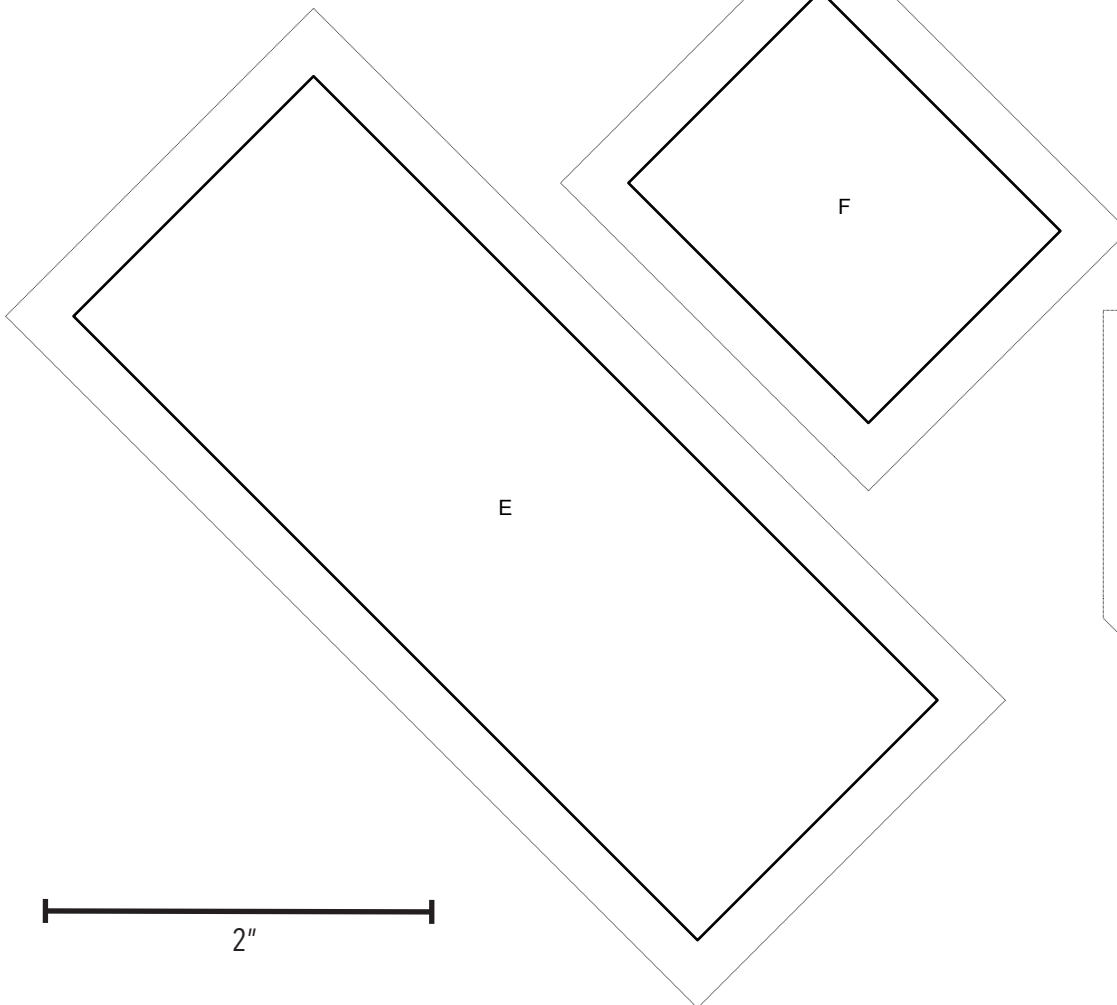
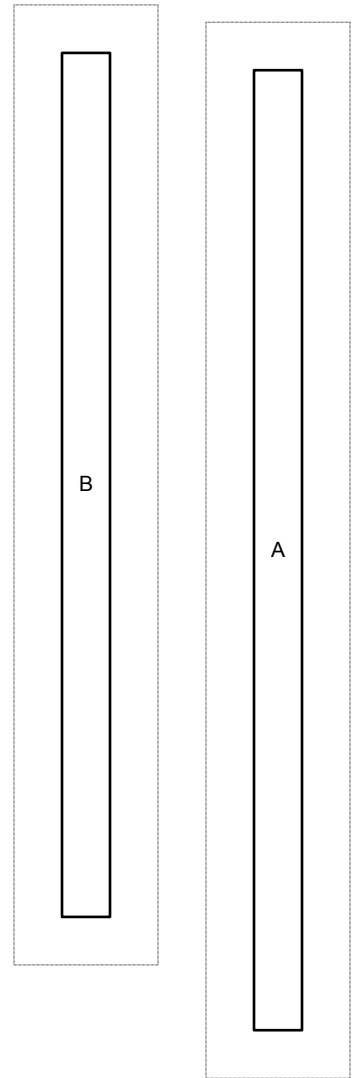
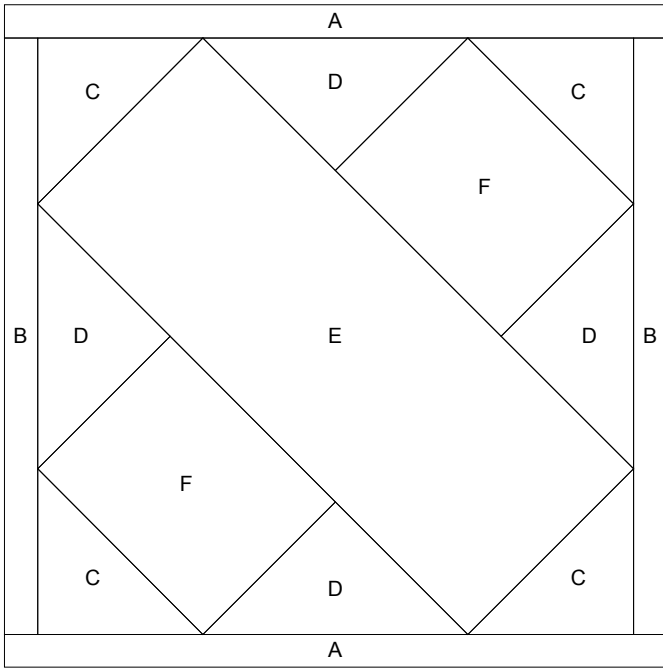

2"

The Jane Stickle Quilt - Block A9

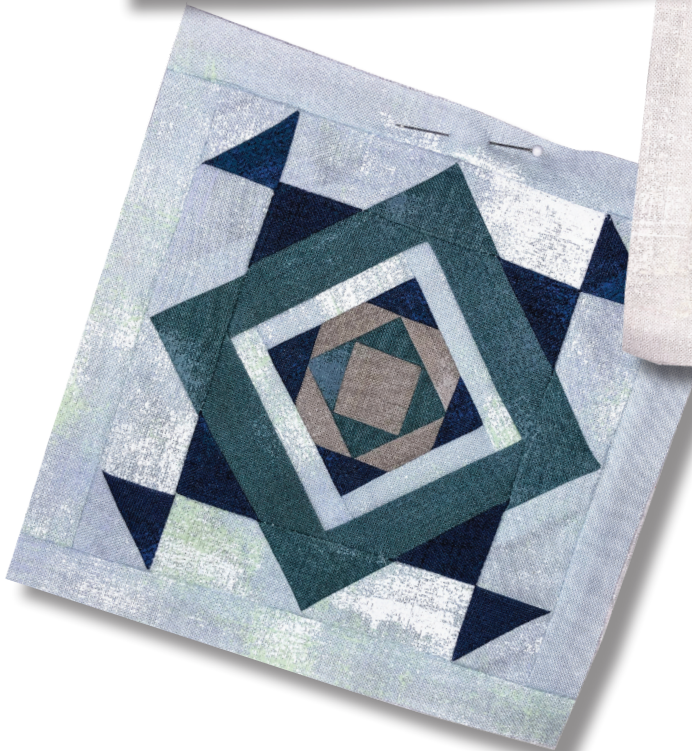

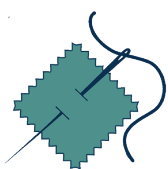

What you need:

Patches	Quantity/size
A*	(2) 1" x 6"
B*	(2) 1" x 5"
C	2 squares 2" x 2", cut once diagonally-light blue 4 squares 2" x 2", cut once diagonally-navy
D	4 rectangles 2" x 3"
E	4 rectangles 2" x 3"
F	4 rectangles 1½" x 4"
G	1 square 3" x 3", cut twice diagonally
H	4 rectangles 1" x 3"
I	1 square 1½" x 1½"
J	2 rectangles 1" x 3"
K	2 rectangles 1" x 3"
L	1 square 3" x 3", cut twice diagonally-navy 1 square 3" x 3", cut twice diagonally-green

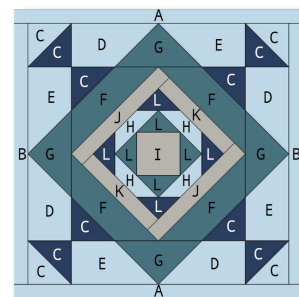

Hobbystash Colorway

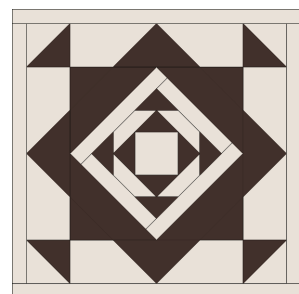

Jane Stickle Colorway

Assembly:

1. Using the templates provided on Page A9-2, create the five foundation sections.
2. Join the sections together.
3. Join Unit B to the right side of the block, and then the left.
4. Join Unit A to the top of the block and then the bottom. Square up block to measure 5½" x 5½"

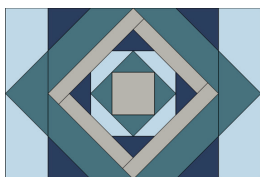

Step 2a

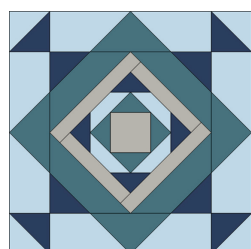

Step 2b

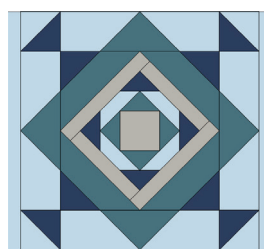

Step 3

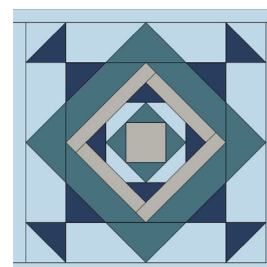

Step 4

**The actual required width for Unit A and Unit B units is ¾". The increased width specified above allows for squaring the block to exactly 5½".*

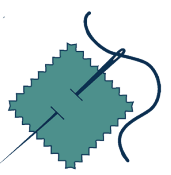

SET PRINTER TO "ACTUAL SIZE" WHEN PRINTING THIS PAGE.

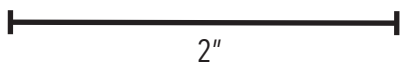
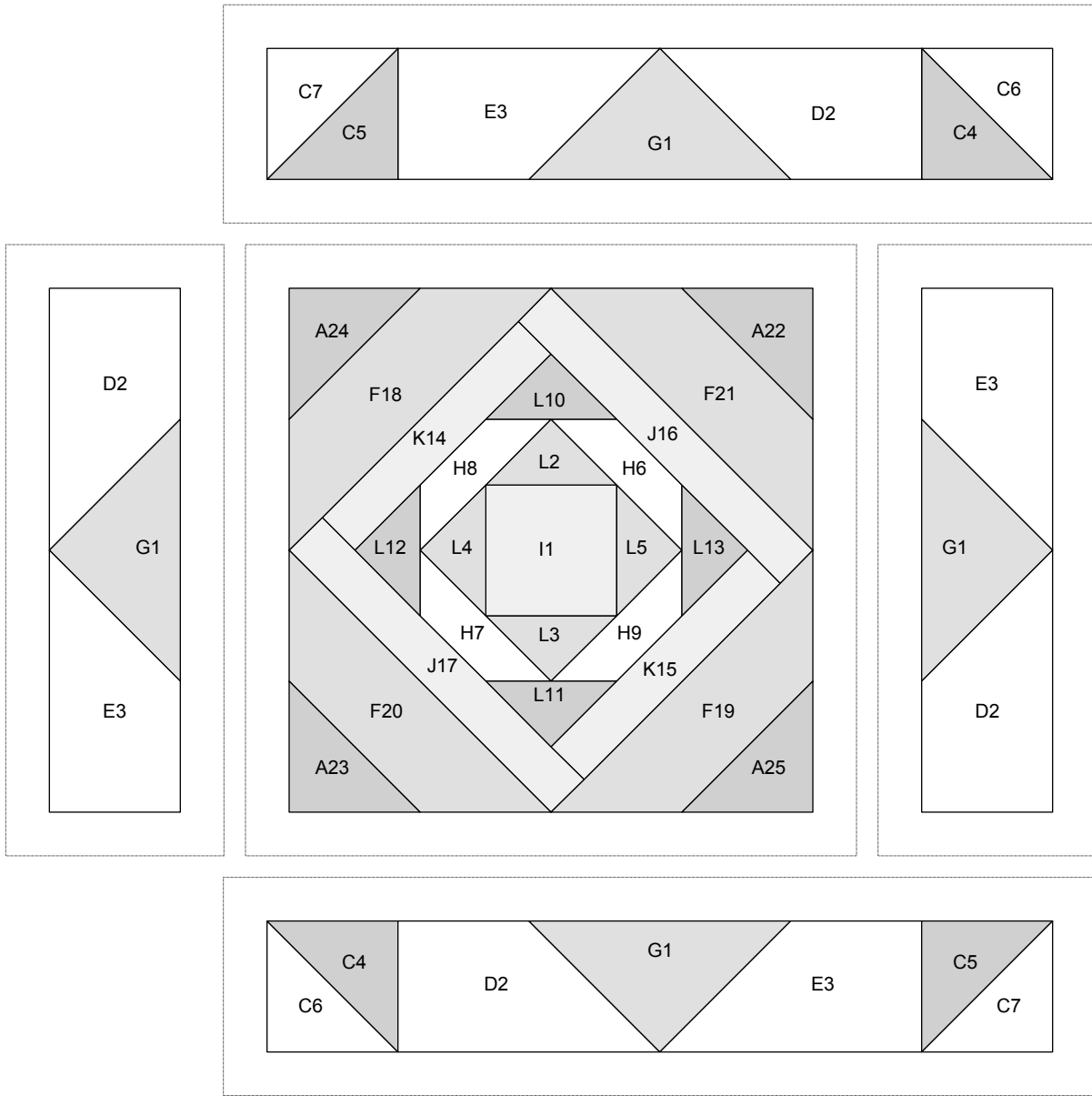

SET PRINTER TO "ACTUAL SIZE" WHEN PRINTING THIS PAGE.

Key Block (69/100 actual size)

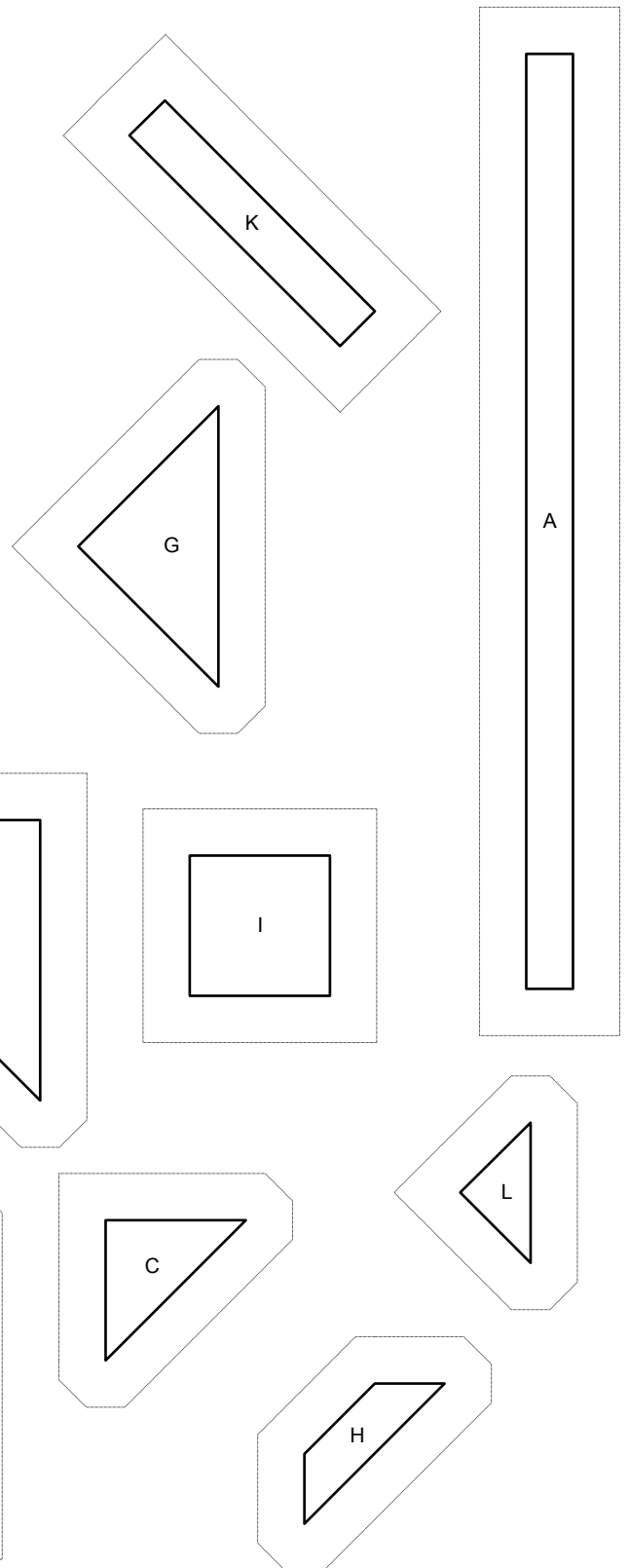
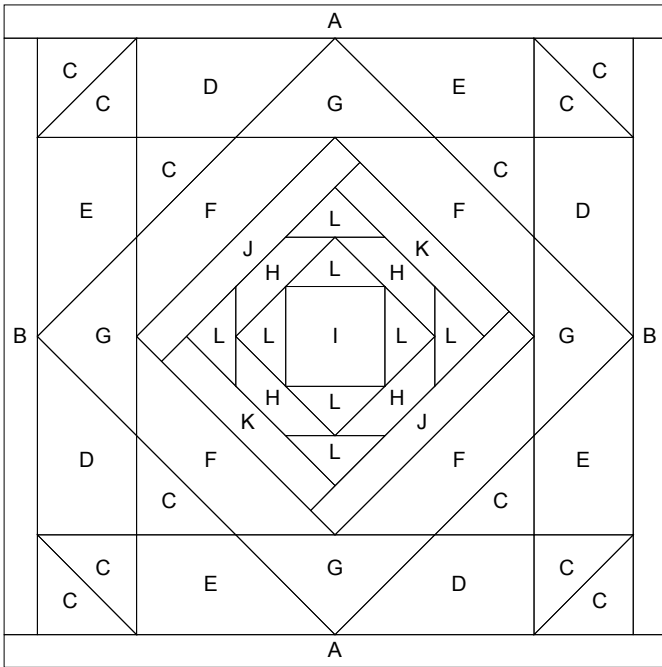

2"

The Jane Stickle Quilt - Block A10

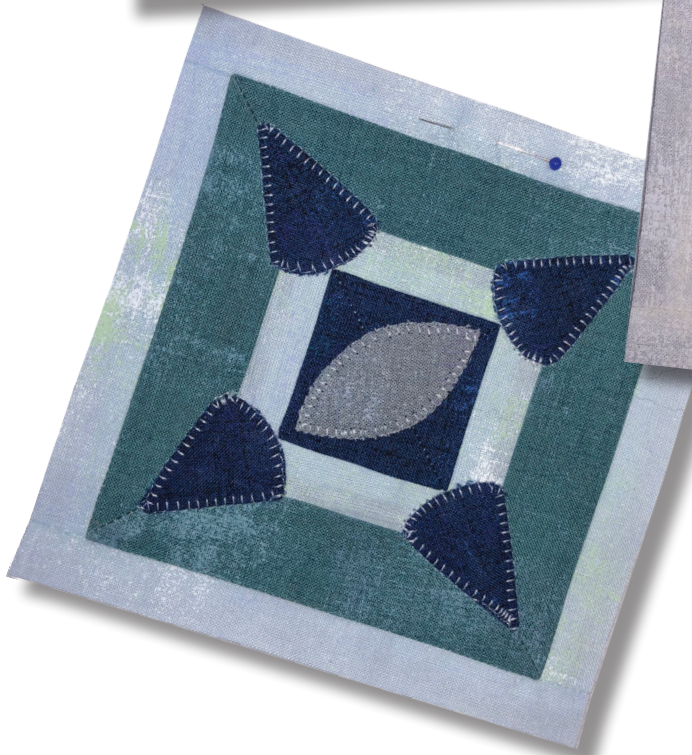

What you need:

Patches	Quantity/size
A*	(2) 1" x 6"
B*	(2) 1" x 5"
C	(4) 2" X 6"
D	(4) 1" X 4"
E	(1) 3" X 3" , cut twice diagonally
F	2" x 2"
G	(4) 2" x 2"

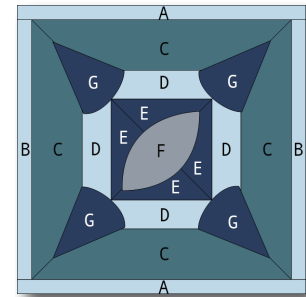

Hobbystash Colorway

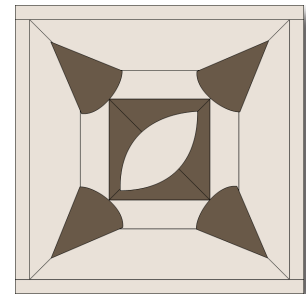

Jane Stickle Colorway

**The actual required width for Unit A and Unit B units is ¾". The increased width specified above allows for squaring the block to exactly 5½".*

Assembly:

1. Using the templates provided on Page A10-2, create the four foundation sections. Join the sections together.
2. Using the templates provided on Page A10-3, applique the cone and melon pieces to the block.
3. Join Unit B to the right side of the block, and then the left.
4. Join Unit A to the top of the block and then the bottom. Square up block to measure 5½" x 5½"



Step 1

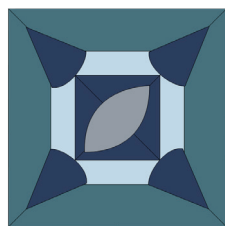

Step 2

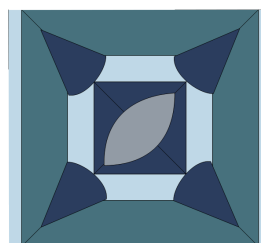

Step 3

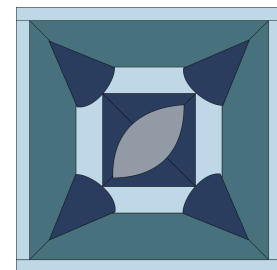

Step 4

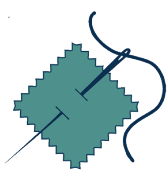

SET PRINTER TO "ACTUAL SIZE" WHEN PRINTING THIS PAGE.

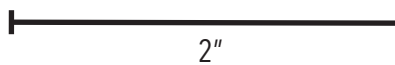
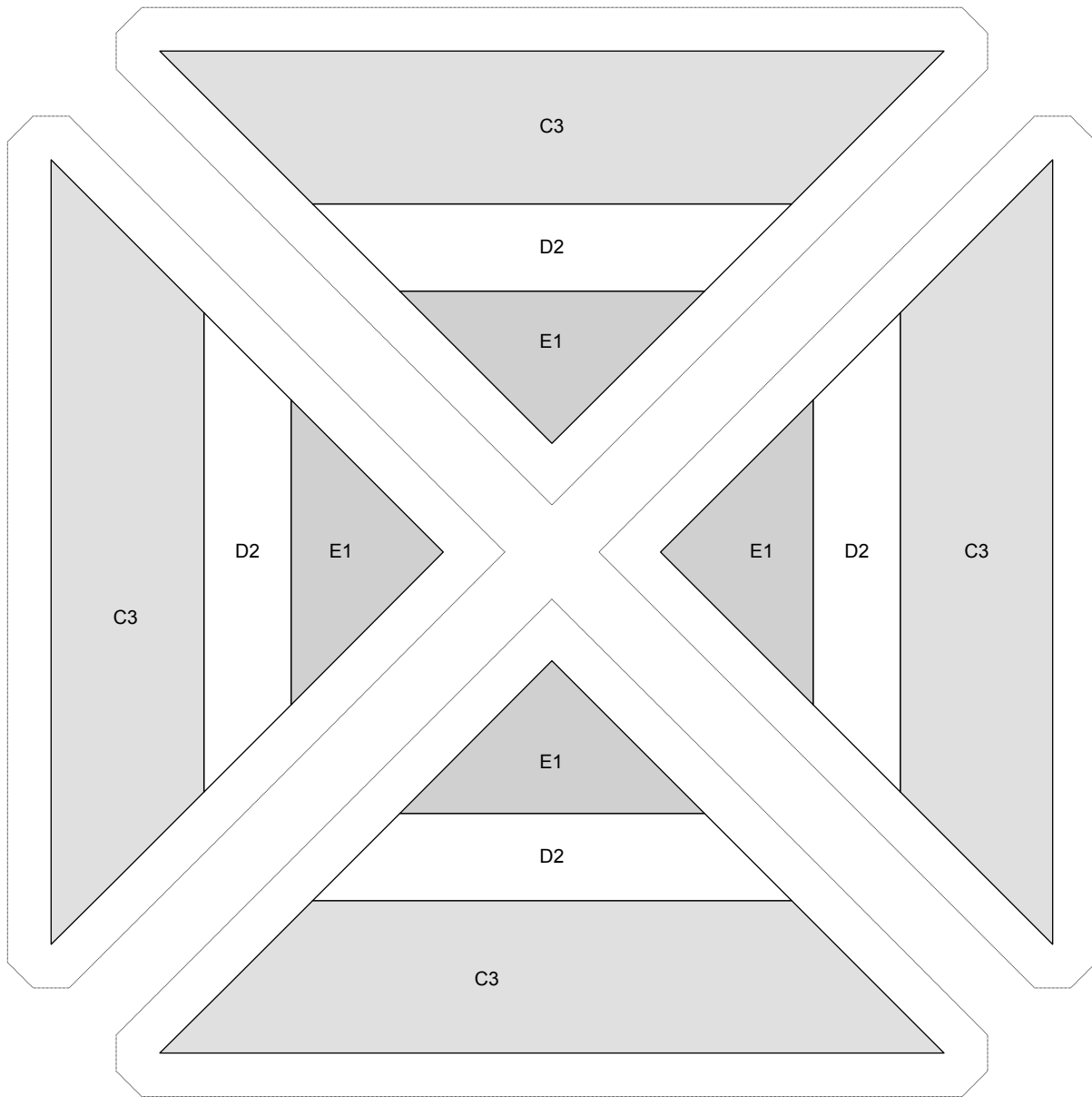

SET PRINTER TO "ACTUAL SIZE" WHEN PRINTING THIS PAGE.

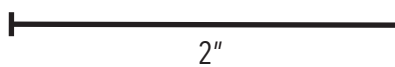
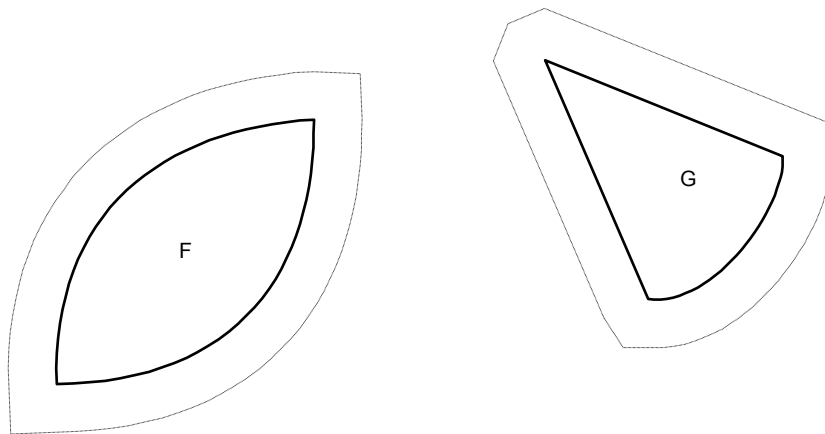

SET PRINTER TO "ACTUAL SIZE" WHEN PRINTING THIS PAGE.

Key Block (69/100 actual size)

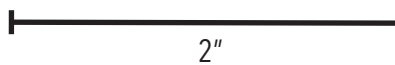
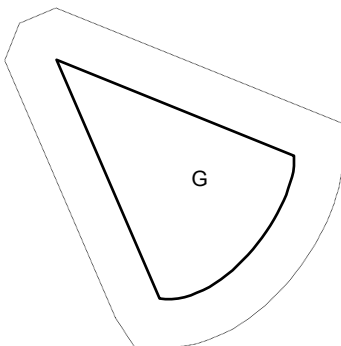
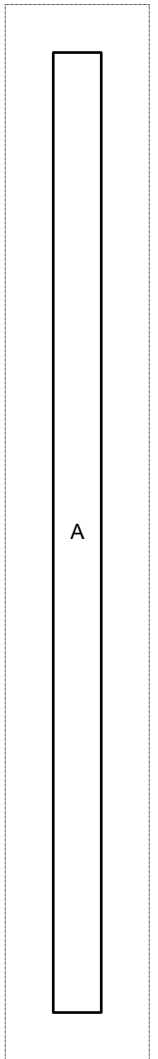
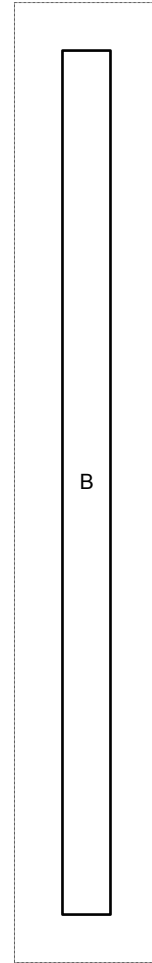
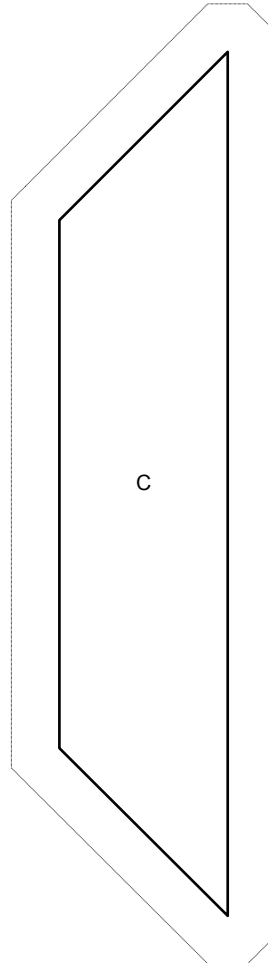
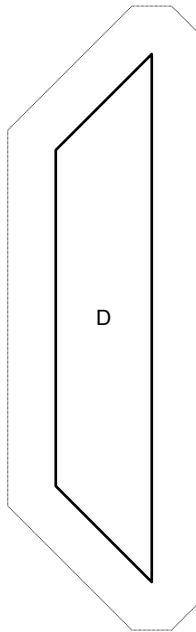
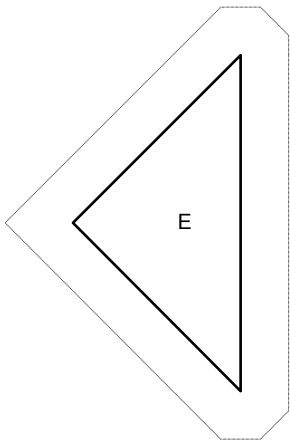
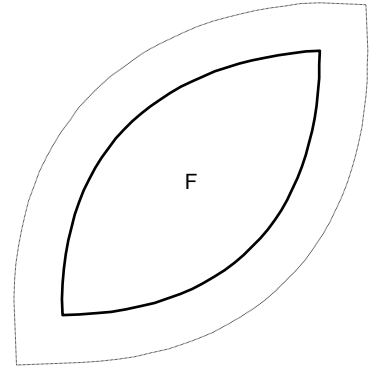
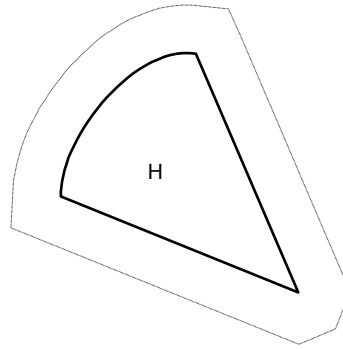
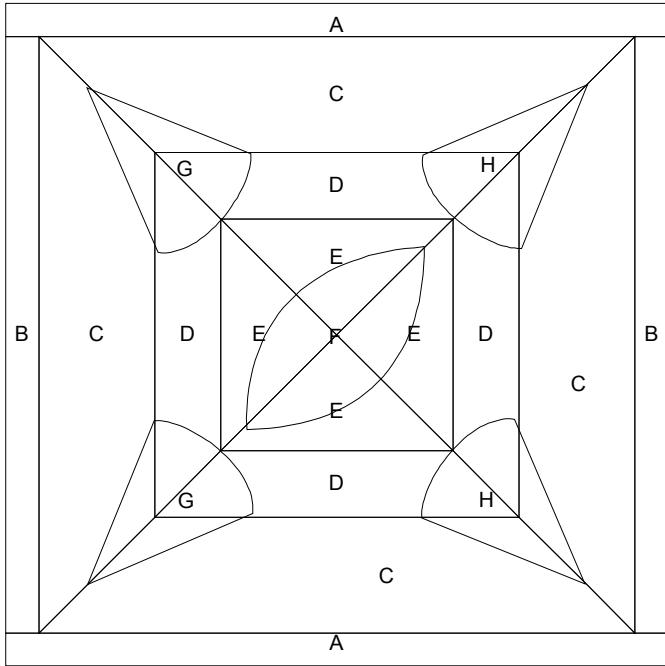

The Jane Stickle Quilt - Block A11



What you need:

Patches	Quantity/size
A*	(2) 1" x 6"
B*	(2) 1" x 5"
C	1 square 2" x 2" - green 4 squares 2" x 2" - navy
D	8 rectangles 1½" x 2" - light blue 4 rectangles 1½" x 2" - beige
E	4 rectangles 1½" x 2"
F	4 rectangles 1½" x 2"
G	4 squares 1½" x 1½"
H	4 squares 2" x 2"

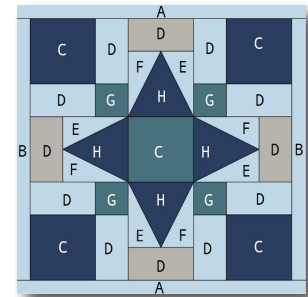

Hobbystash Colorway

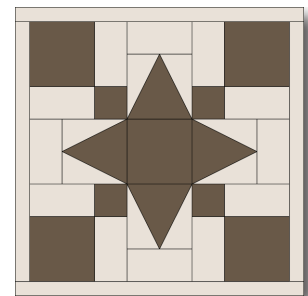

Jane Stickle Colorway

Assembly:

- Using the templates provided on Page A11-2, create the eleven foundation sections.
- Join the sections together.
- Join Unit B to the right side of the block, and then the left.
- Join Unit A to the top of the block and then the bottom. Square up block to measure 5½" x 5½"

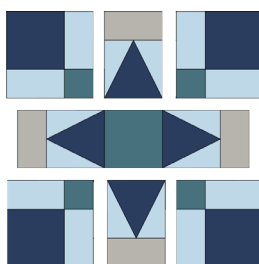

Step 2a

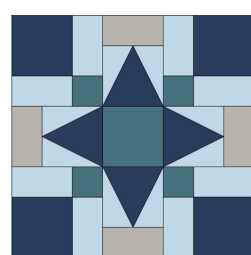

Step 2b

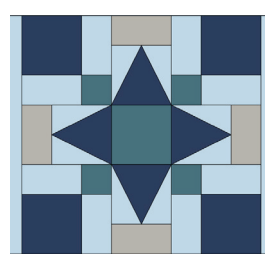

Step 3

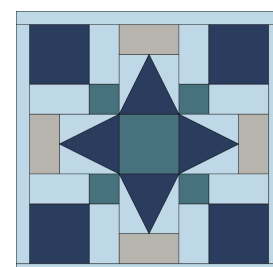

Step 4

**The actual required width for Unit A and Unit B units is ¾". The increased width specified above allows for squaring the block to exactly 5½".*

SET PRINTER TO "ACTUAL SIZE" WHEN PRINTING THIS PAGE.

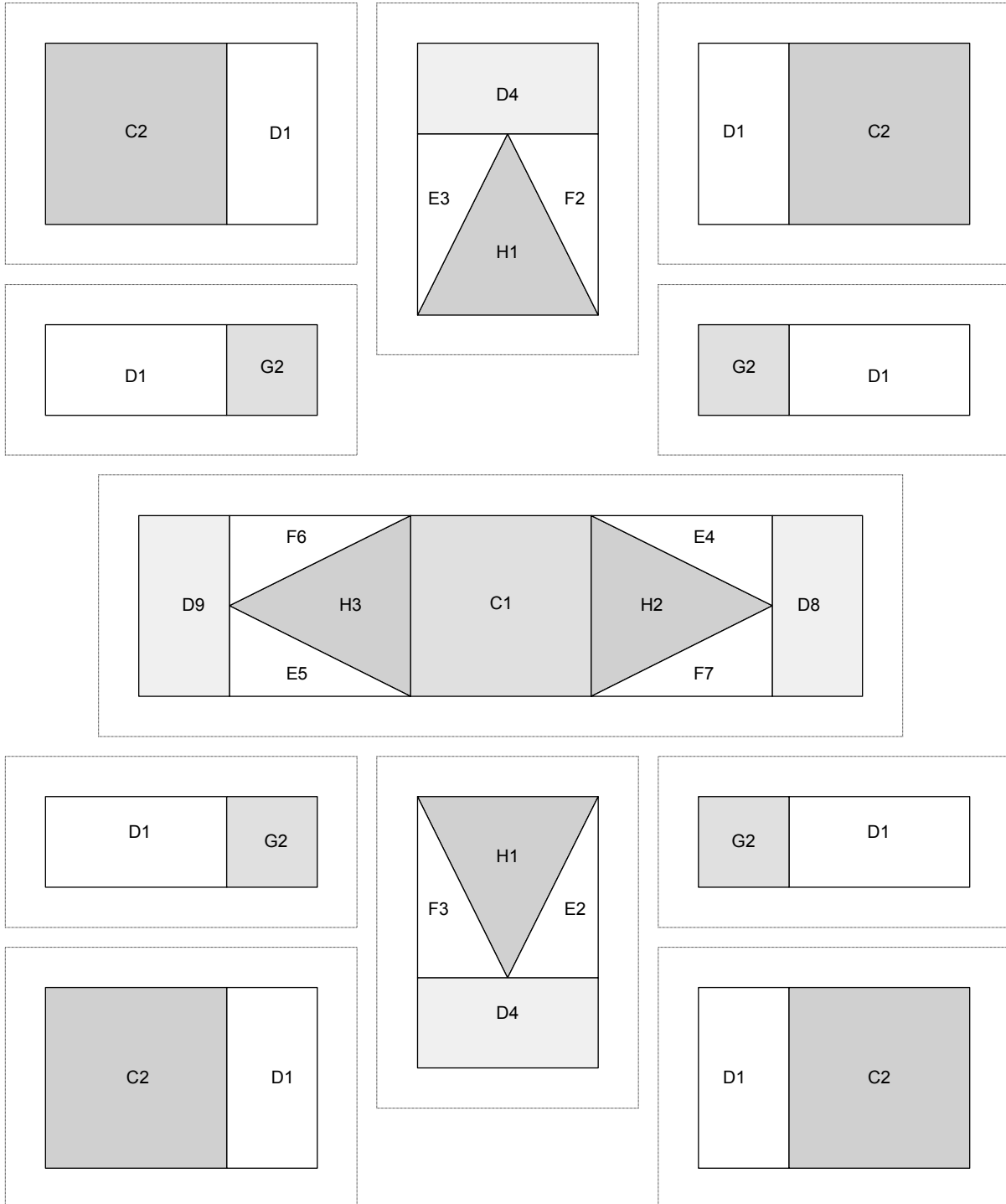

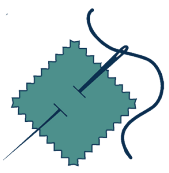

SET PRINTER TO "ACTUAL SIZE" WHEN PRINTING THIS PAGE.

Key Block (69/100 actual size)

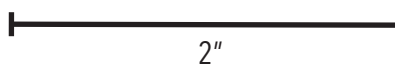
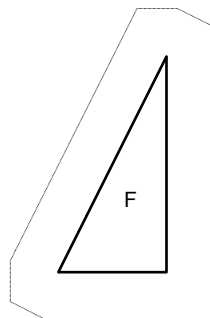
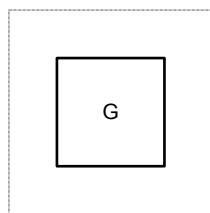
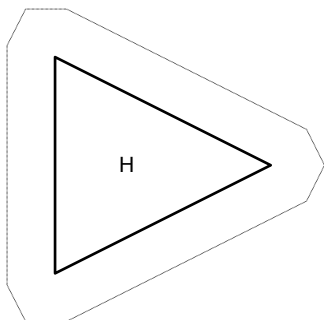
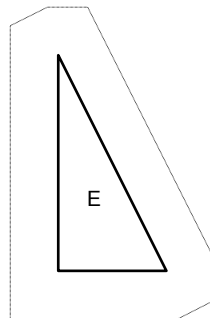
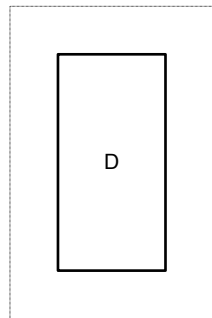
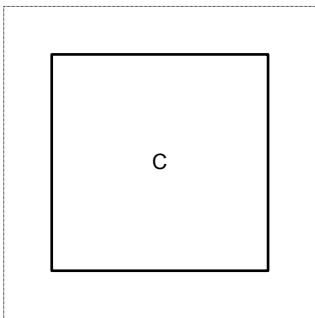
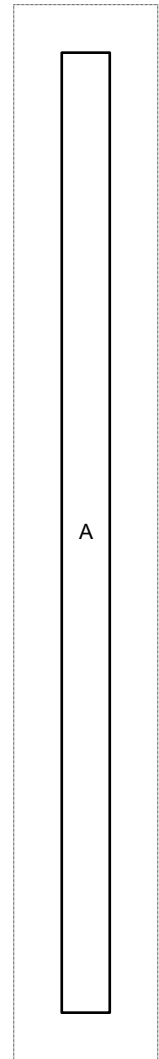
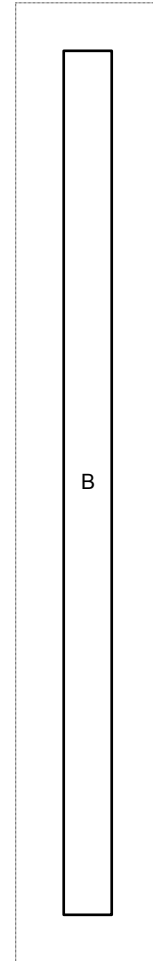
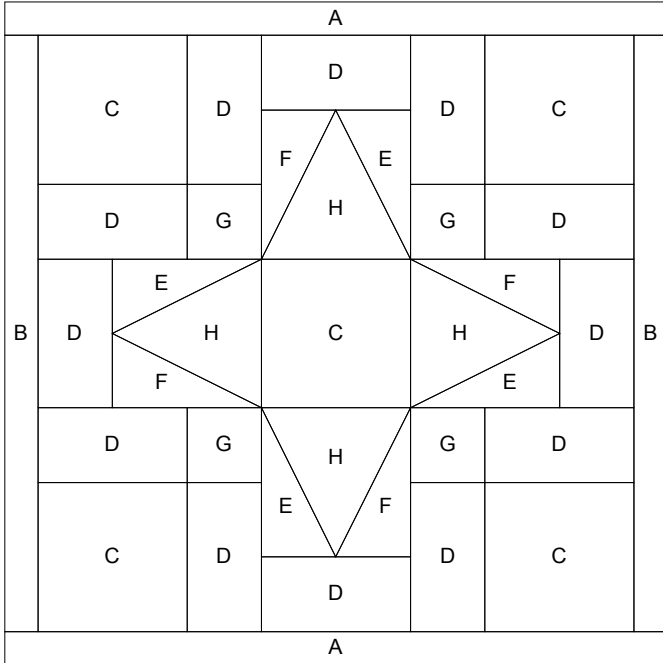

The Jane Stickle Quilt - Block A12

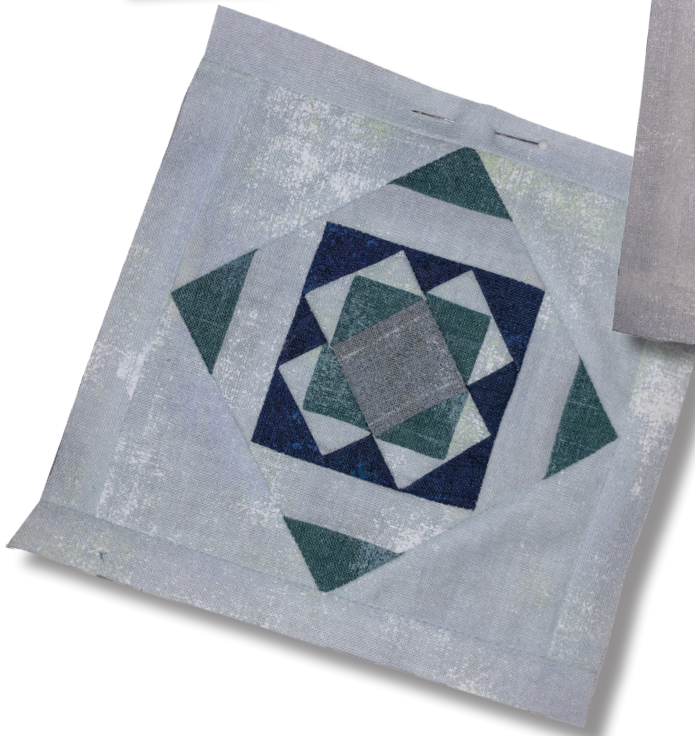

What you need:

Patches	Quantity/size
A*	(2) 1" x 6"
B*	(2) 1" x 5"
C	2 square 3½" x 3½", cut once diagonally
D	2 squares 2" x 2", cut once diagonally - navy 2 squares 2" x 2", cut once diagonally - green
E	1 square 2½" x 2½", cut twice diagonally - navy 2 squares 2½" x 2½", cut twice diagonally - light blue
F	1 square 2" x 2"
G	4 rectangles 1½" x 4"
H	1 square 3" x 3" cut twice diagonally

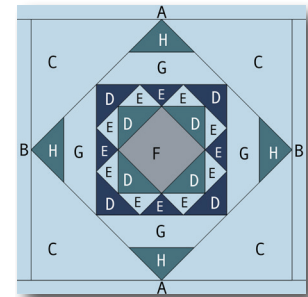

Hobbystash Colorway

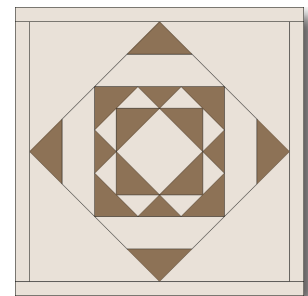

Jane Stickle Colorway

Assembly:

- Using the templates provided on Page A12-2, create the eleven foundation sections.
- Join the sections together.
- Join Unit B to the right side of the block, and then the left.
- Join Unit A to the top of the block and then the bottom. Square up block to measure 5½" x 5½"

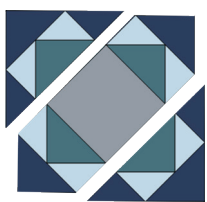

Step 2a



Step 2b

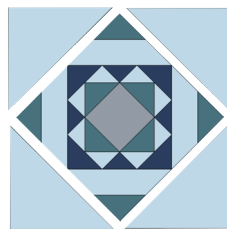

Step 2c

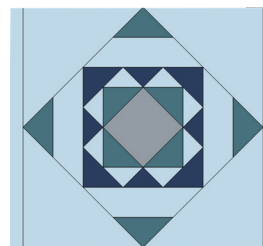

Step 3

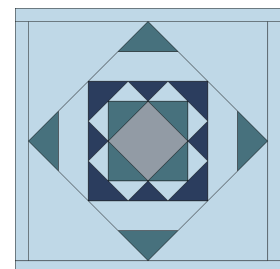

Step 4

**The actual required width for Unit A and Unit B units is ¾". The increased width specified above allows for squaring the block to exactly 5½".*

SET PRINTER TO "ACTUAL SIZE" WHEN PRINTING THIS PAGE.

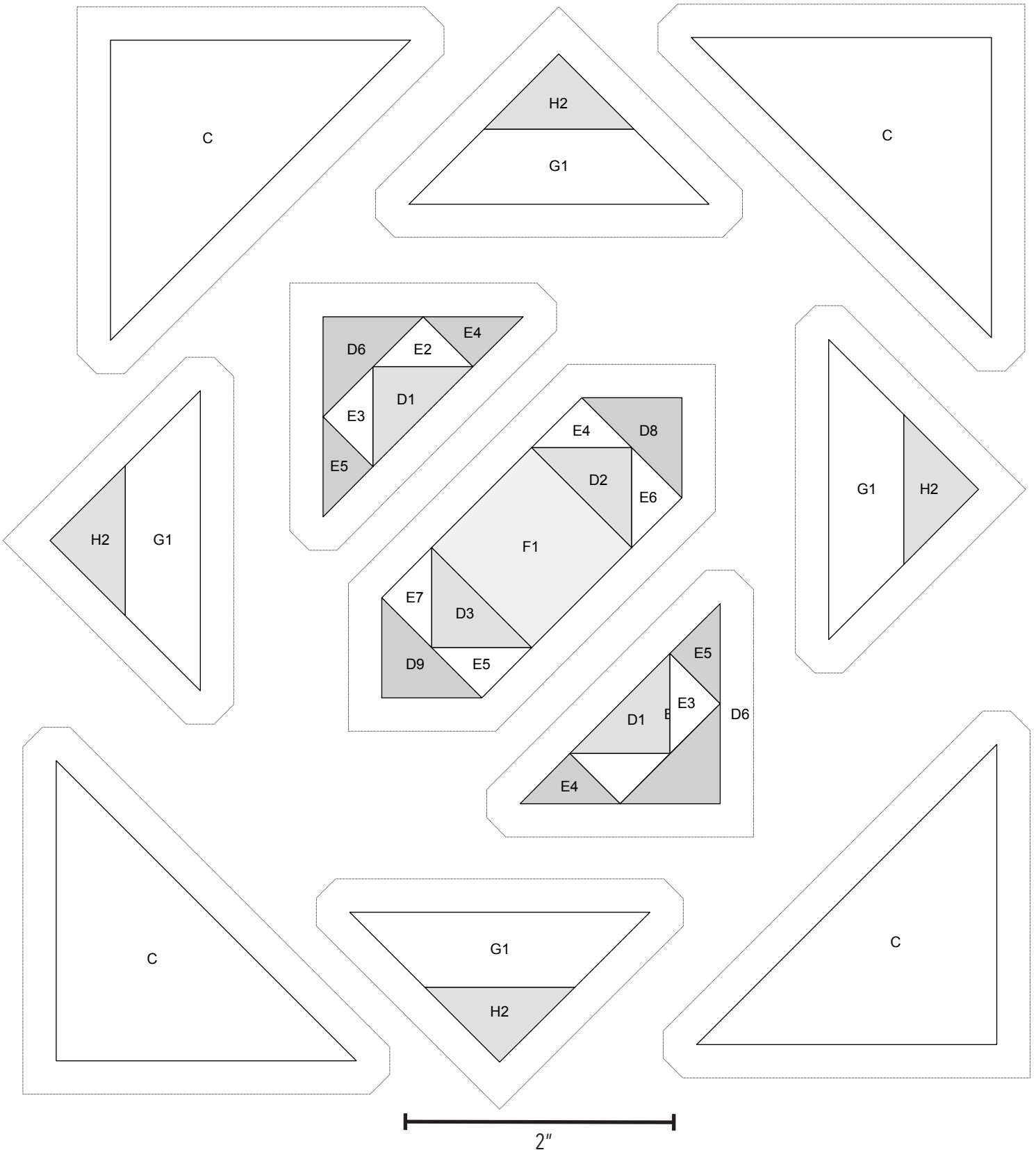

SET PRINTER TO "ACTUAL SIZE" WHEN PRINTING THIS PAGE.

Key Block (69/100 actual size)

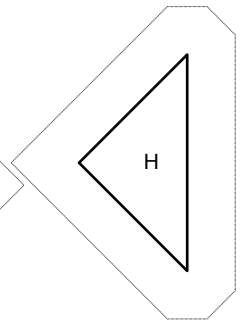
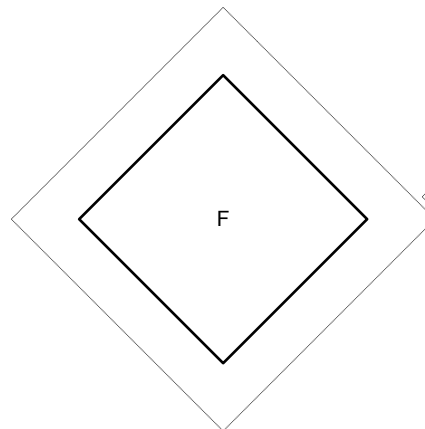
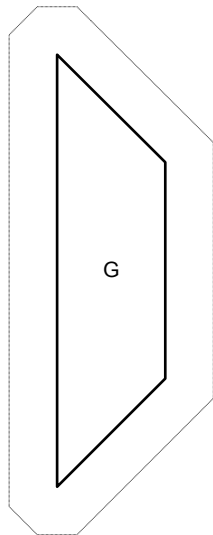
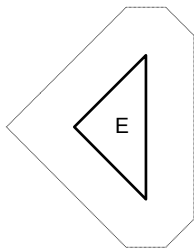
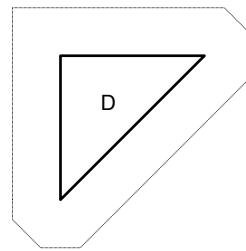
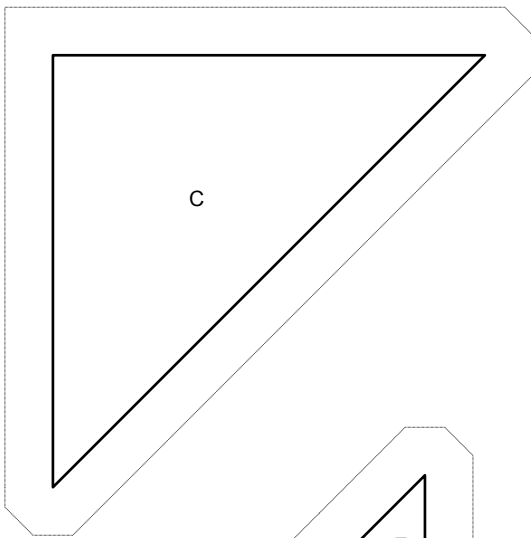
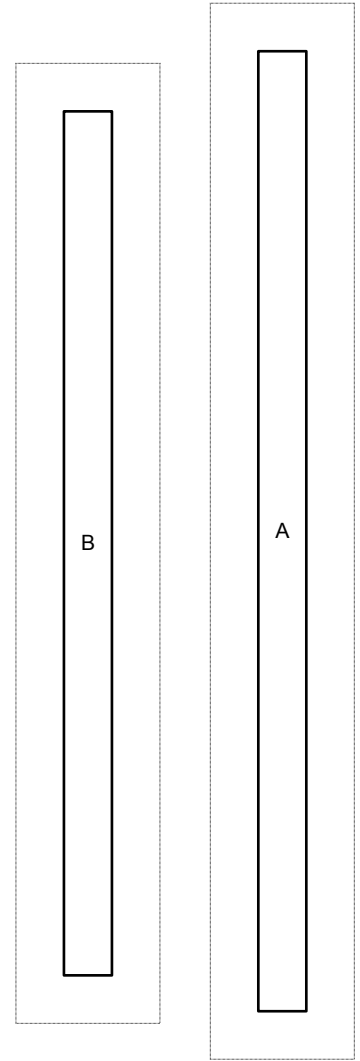
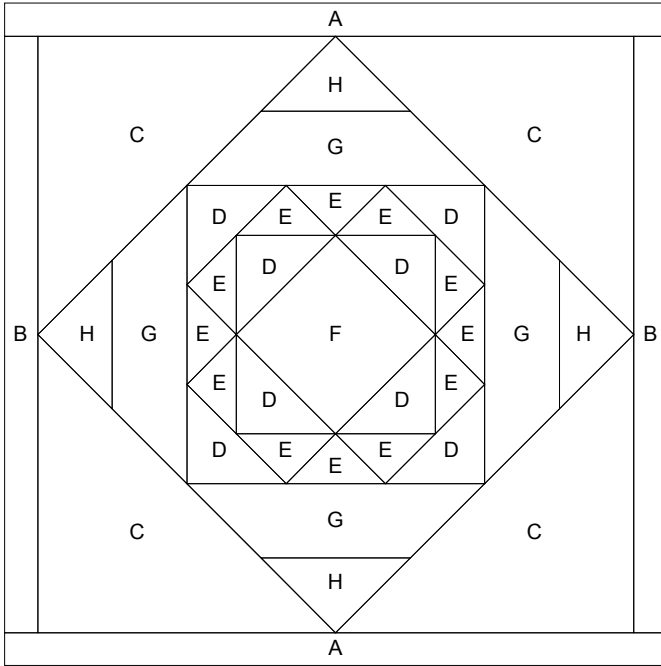

2"

The Jane Stickle Quilt - Block A13

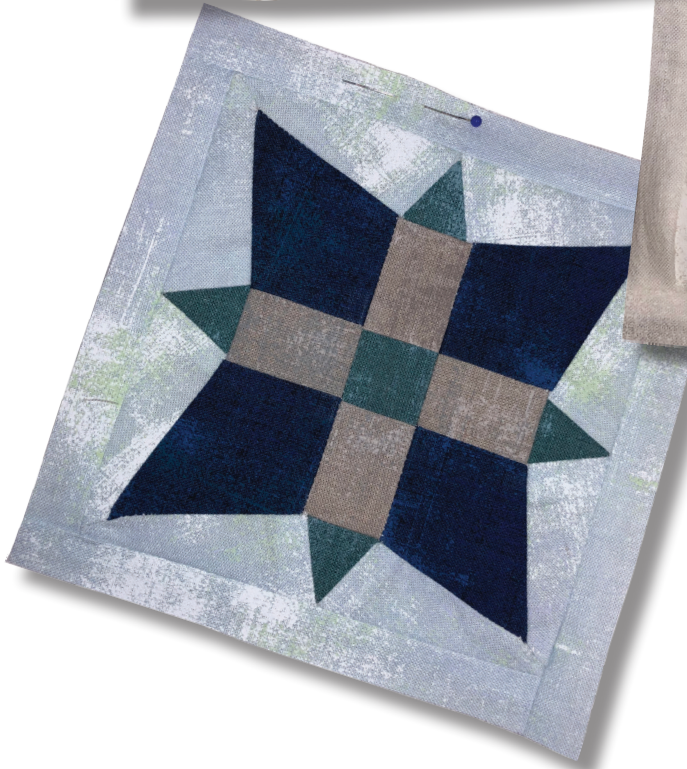

What you need:

Patches	Quantity/size
A*	(2) 1" x 6"
B*	(2) 1" x 5"
C	4 rectangles 2" x 3"
D	4 rectangles 2" x 3"
E	4 squares 2½" x 2½"
F	4 squares 1½" x 1½"
G	4 rectangles 1½" x 2"
H	1 square 1½" x 1½"

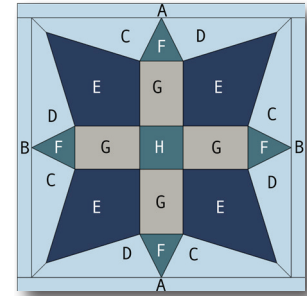

Hobbystash Colorway

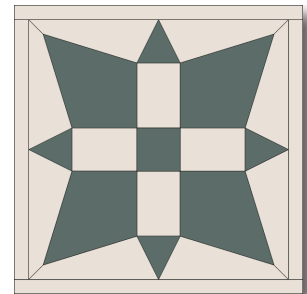

Jane Stickle Colorway

Assembly:

- Using the templates provided on Page A12-2, create the seven foundation sections.
- Join the sections together.
- Join Unit B to the right side of the block, and then the left.
- Join Unit A to the top of the block and then the bottom. Square up block to measure 5½" x 5½"



Step 2a

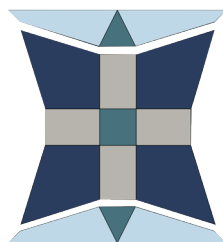

Step 2b

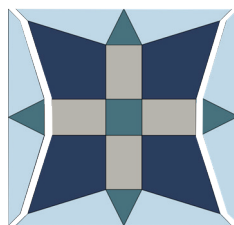

Step 2c

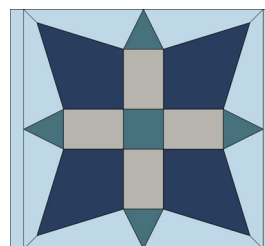

Step 3

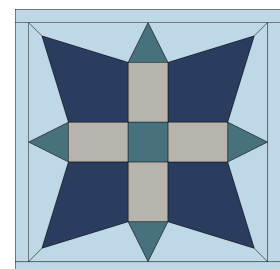

Step 4

**The actual required width for Unit A and Unit B units is ¾". The increased width specified above allows for squaring the block to exactly 5½".*

SET PRINTER TO "ACTUAL SIZE" WHEN PRINTING THIS PAGE.

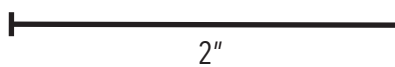
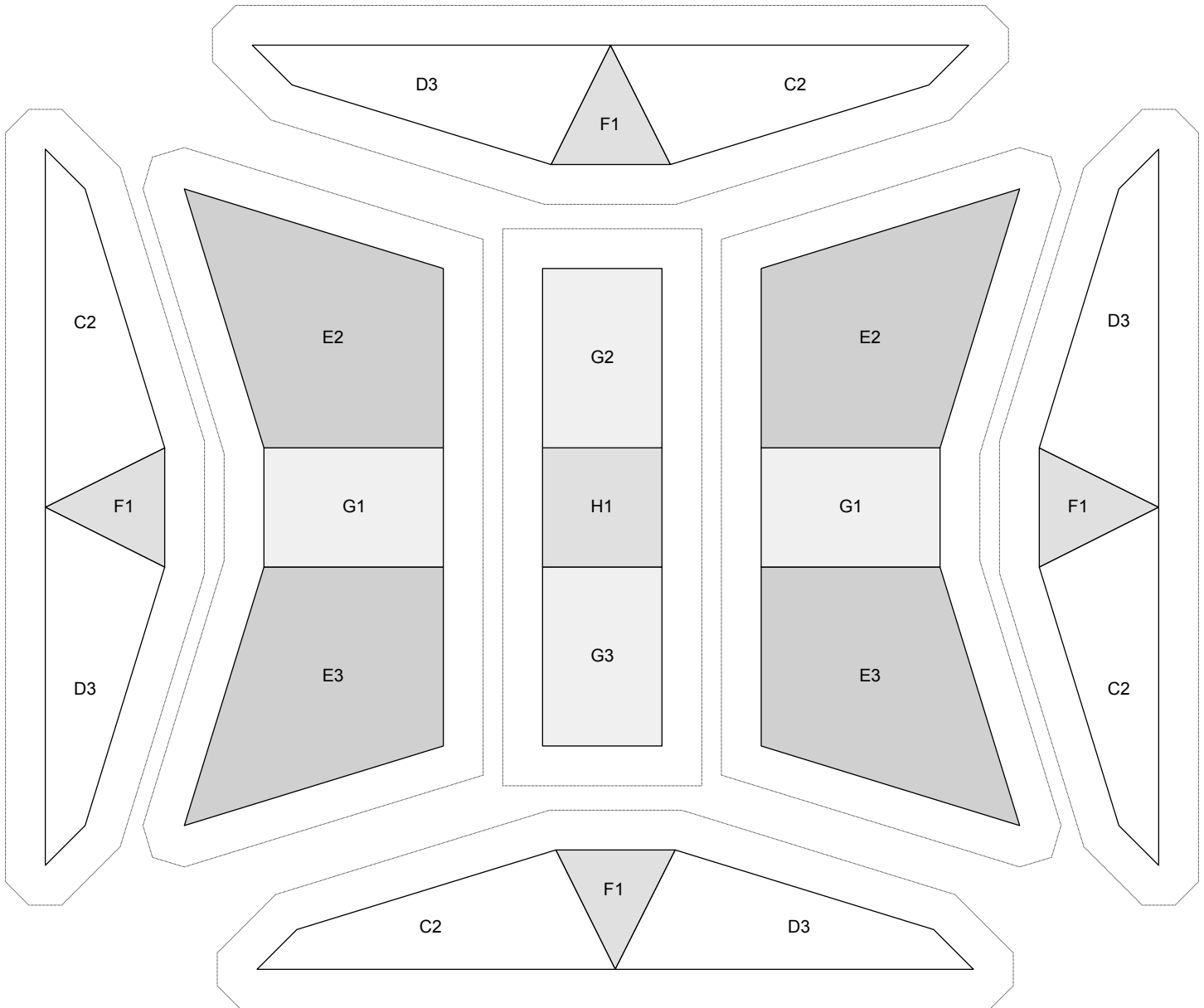

SET PRINTER TO "ACTUAL SIZE" WHEN PRINTING THIS PAGE.

Key Block (69/100 actual size)

