

# The Jane Stickle Quilt - Top Border

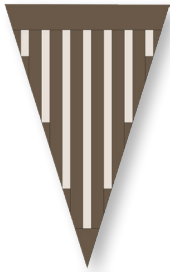

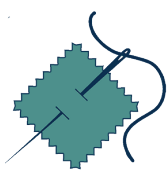

BT1



BT2

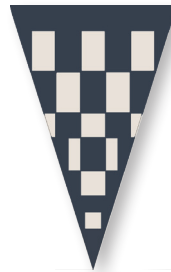

BT3



BT4



BT5



BT6



BT7

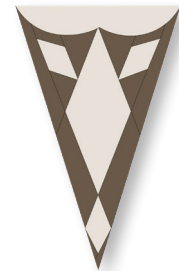

BT8

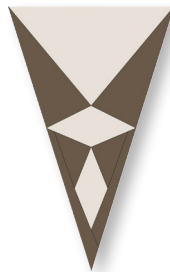

BT9



BT10



BT11



BT12



BT13

## The Jane Stickle Quilt - Block BT1



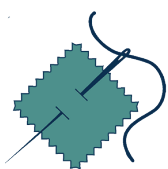

### What you need:

Patches	Quantity/size
A	(1) 1½" x 6"
B	assigned by EQ but not used
C	assigned by EQ but not used
D/I	(4 each) 1" x 1½"
E/K	(1 each) 1¼" x 3½"
F/M	(1 each) 1¼" x 6½"
G/O	(1 each) 1¼" x 7"
H	(1) 2" x 2½"
J	(2) 1" x 1½"
L	(2) 1" x 3½"
N	(2) 1" x 5½"
P	(1) 1" x 7"

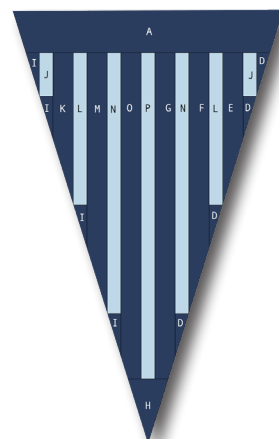

Hobbystash Colorway

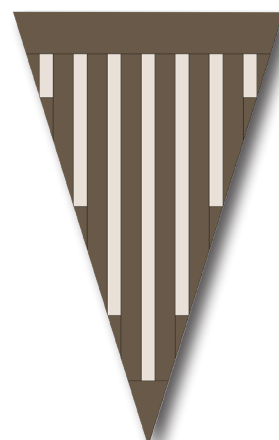

Jane Stickle Colorway

### Assembly:

1. Using the templates provided on Page BT1-2 and BT1-3, foundation piece each section.
2. Join the sections together.

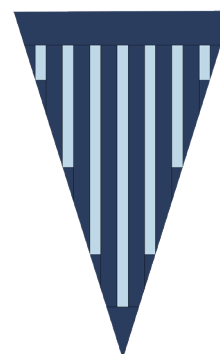
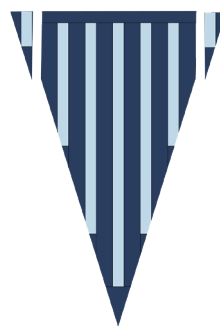
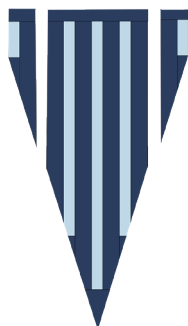



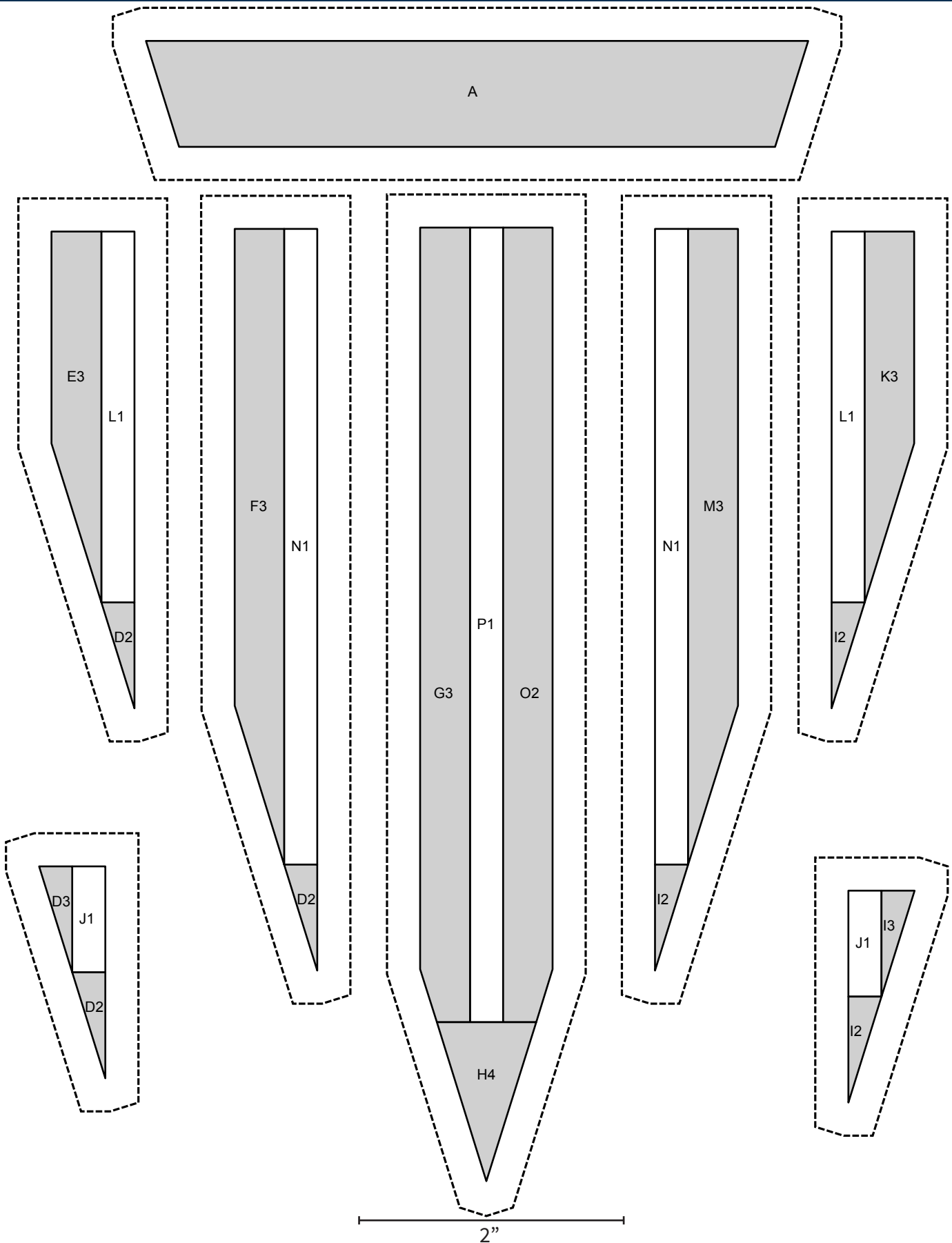

SET PRINTER TO "ACTUAL SIZE" WHEN PRINTING THIS PAGE.

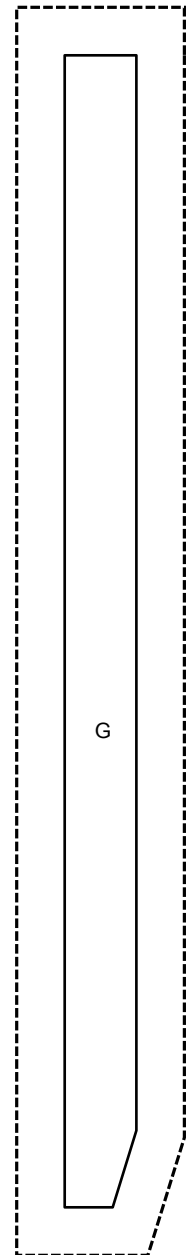
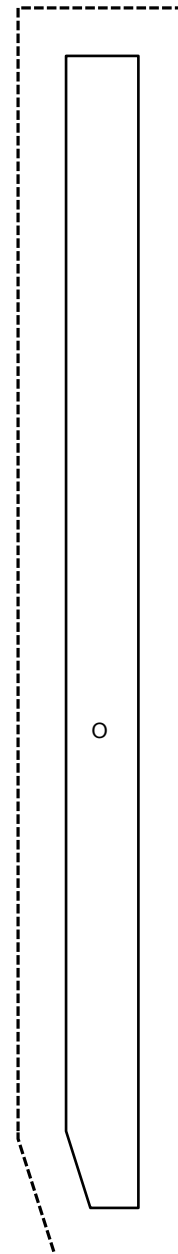
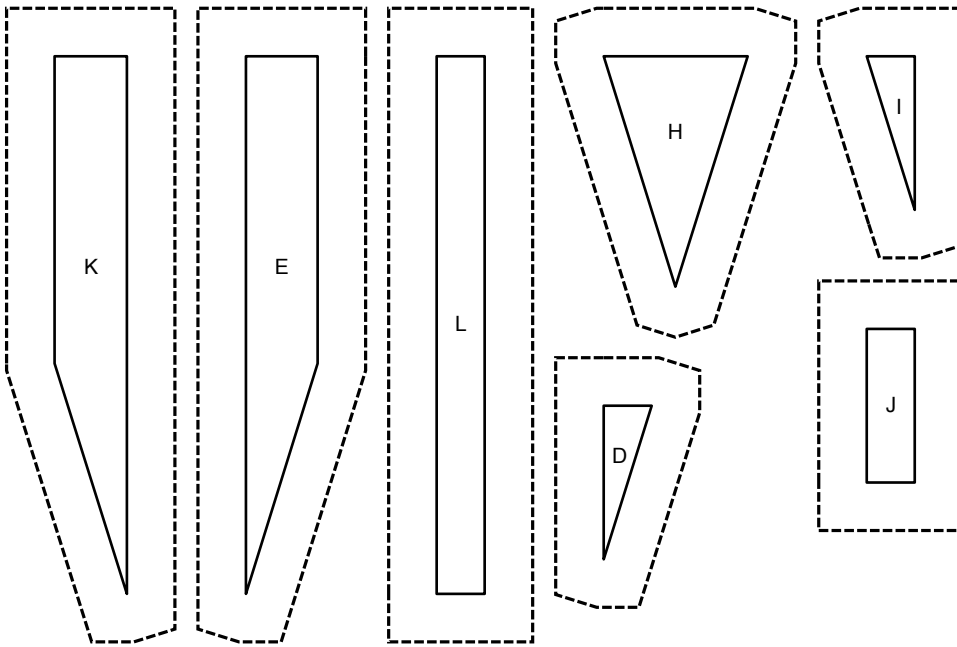
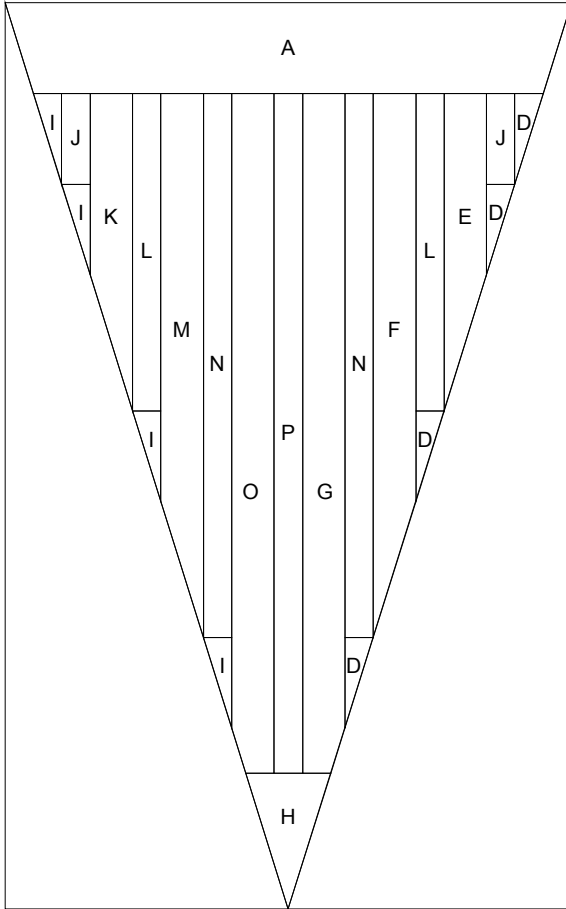

2"

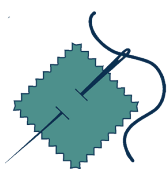

SET PRINTER TO "ACTUAL SIZE" WHEN PRINTING THIS PAGE.

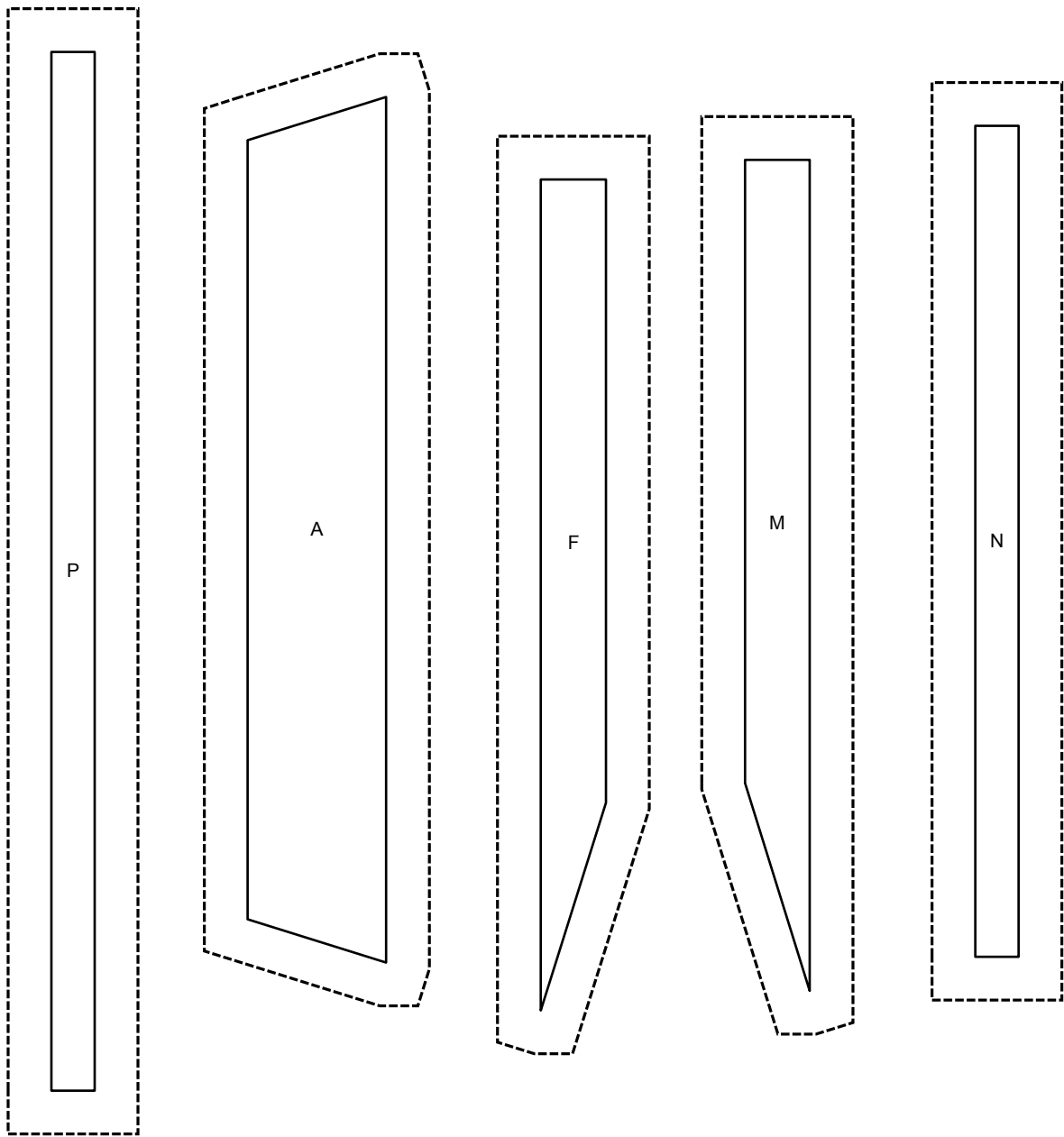

2"

## The Jane Stickle Quilt - Block BT2



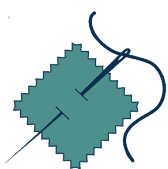

### What you need:

Patches	Quantity/size
F/G	assigned by EQ but not used
A/E	(1 each) 1" x 9½"
B/D	(1 each) 1½" x 3"
C	(1) 3" x 8"
H/Q	(1 each) 1½" x 3"
I/R	(1 each) 1½" x 3"
J/S	(1 each) 1½" x 3"
K/T	(1 each) 1½" x 3"
L/U	(1 each) 1½" x 3"
M/V	(1 each) 1½" x 3"
N/W	(1 each) 1½" x 3"
O/X	(1 each) 1" x 2½"
P	(1) 2" x 3"

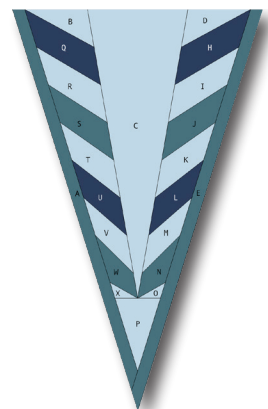

Hobbystash Colorway

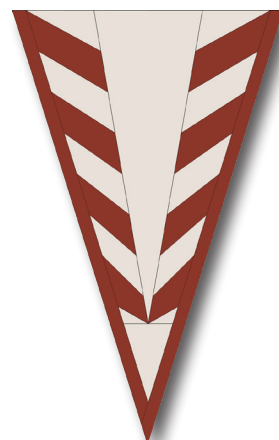

Jane Stickle Colorway

### Assembly:

1. Using the templates provided on Page BT2-2, foundation piece each section.
2. Join the sections together.

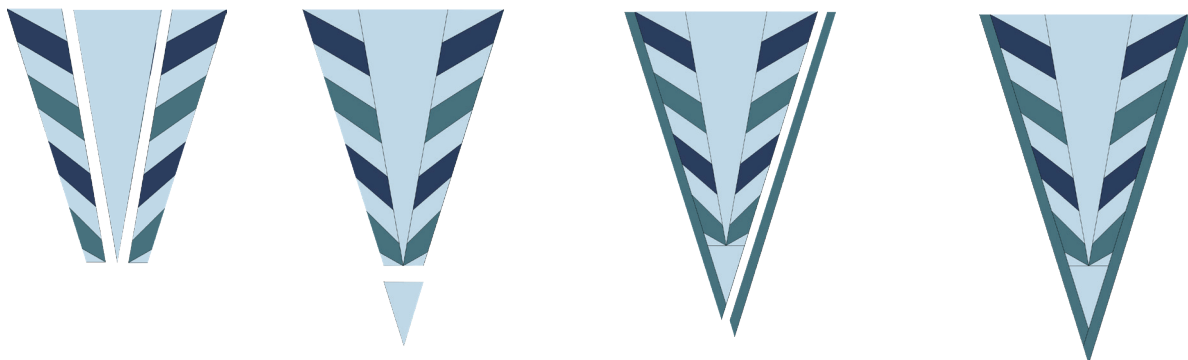



SET PRINTER TO "ACTUAL SIZE" WHEN PRINTING THIS PAGE.

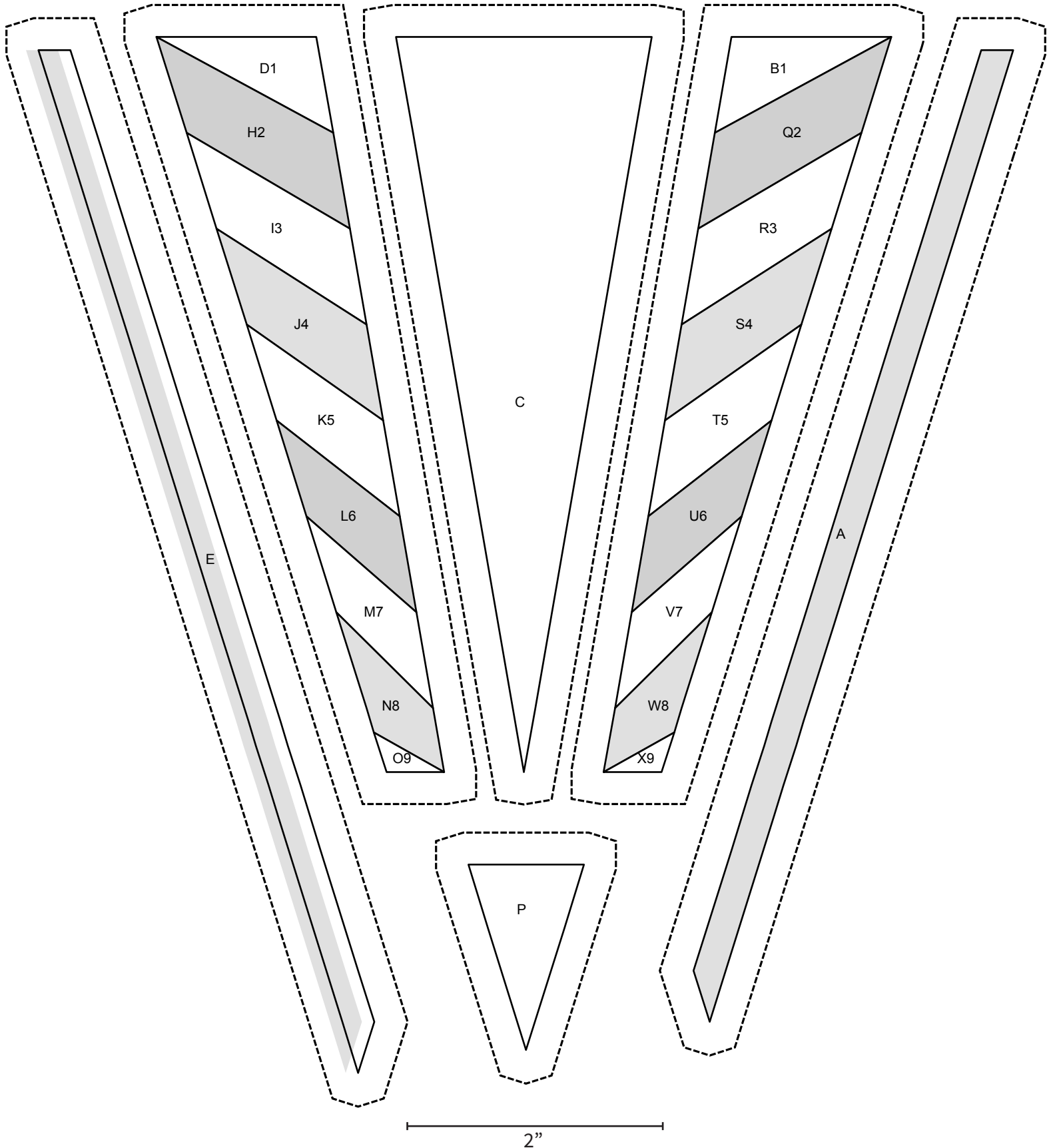

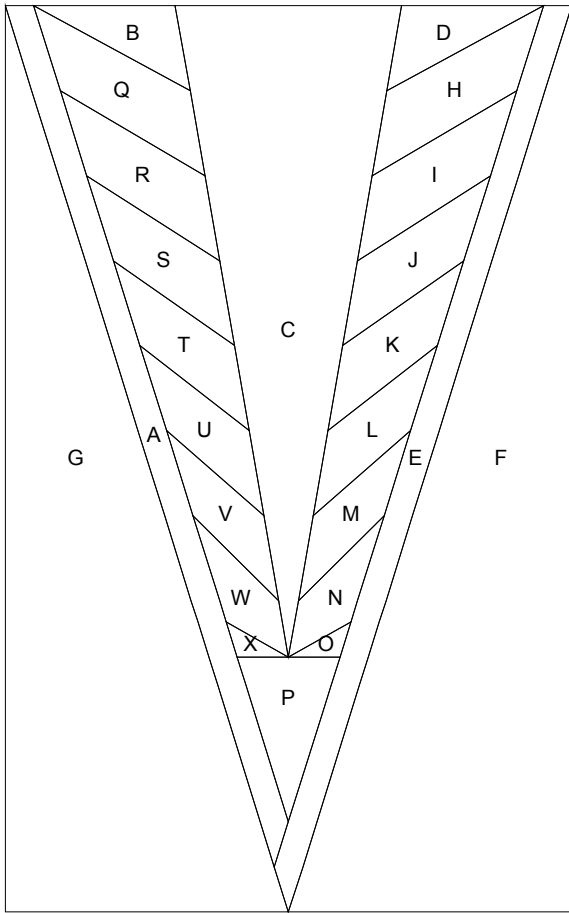

SET PRINTER TO "ACTUAL SIZE" WHEN PRINTING THIS PAGE.

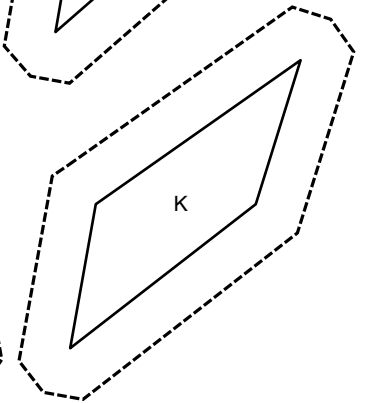
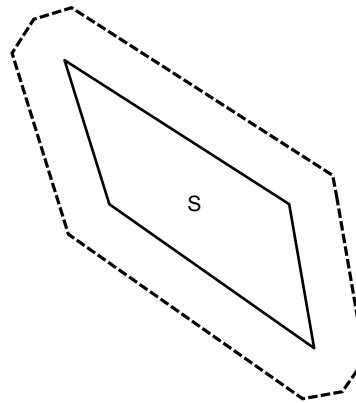
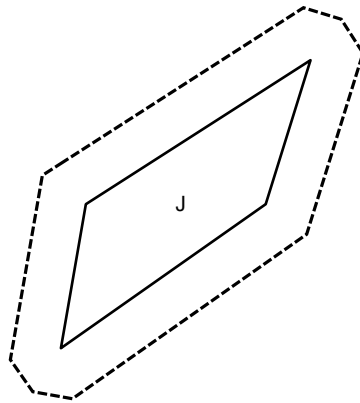
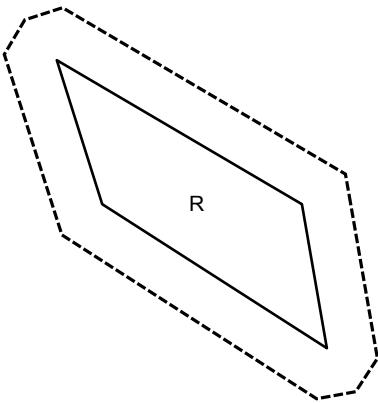
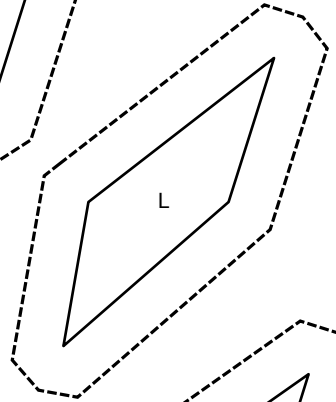
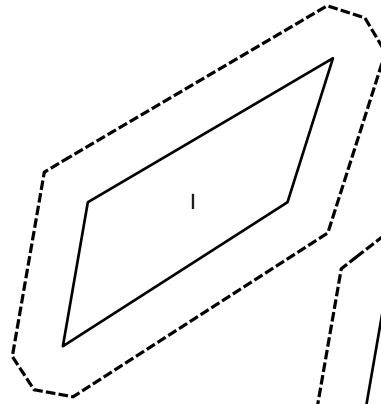
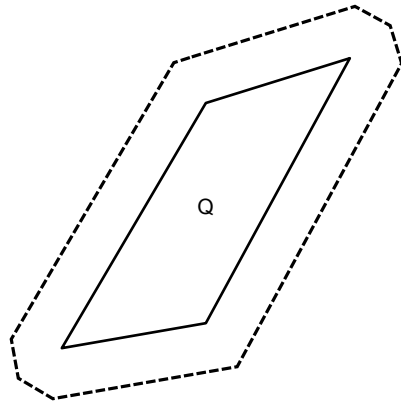
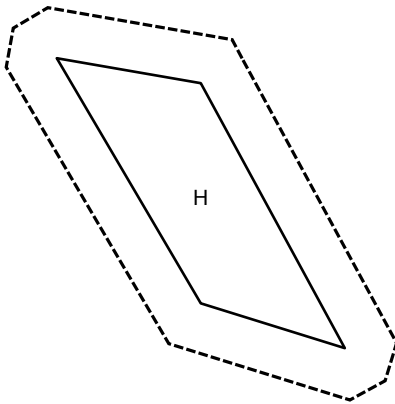
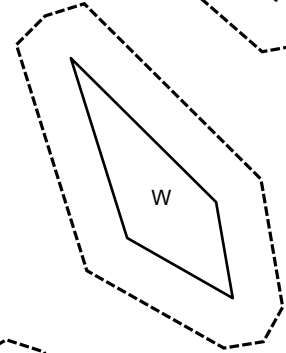
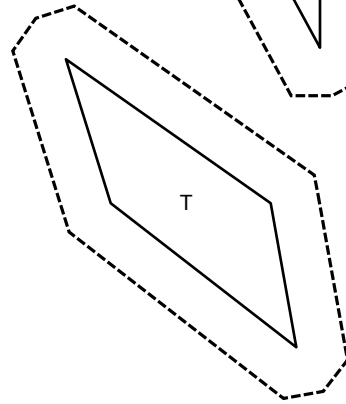
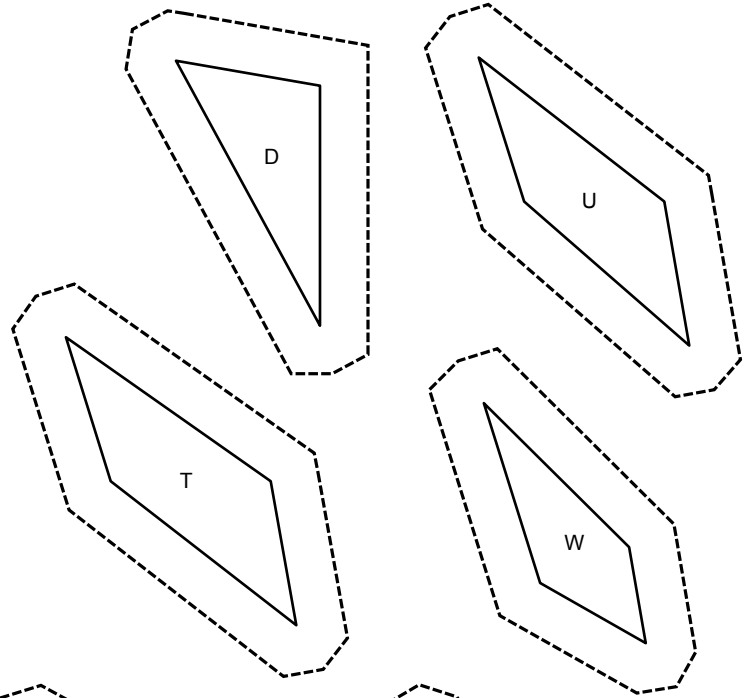

2"

SET PRINTER TO "ACTUAL SIZE" WHEN PRINTING THIS PAGE.

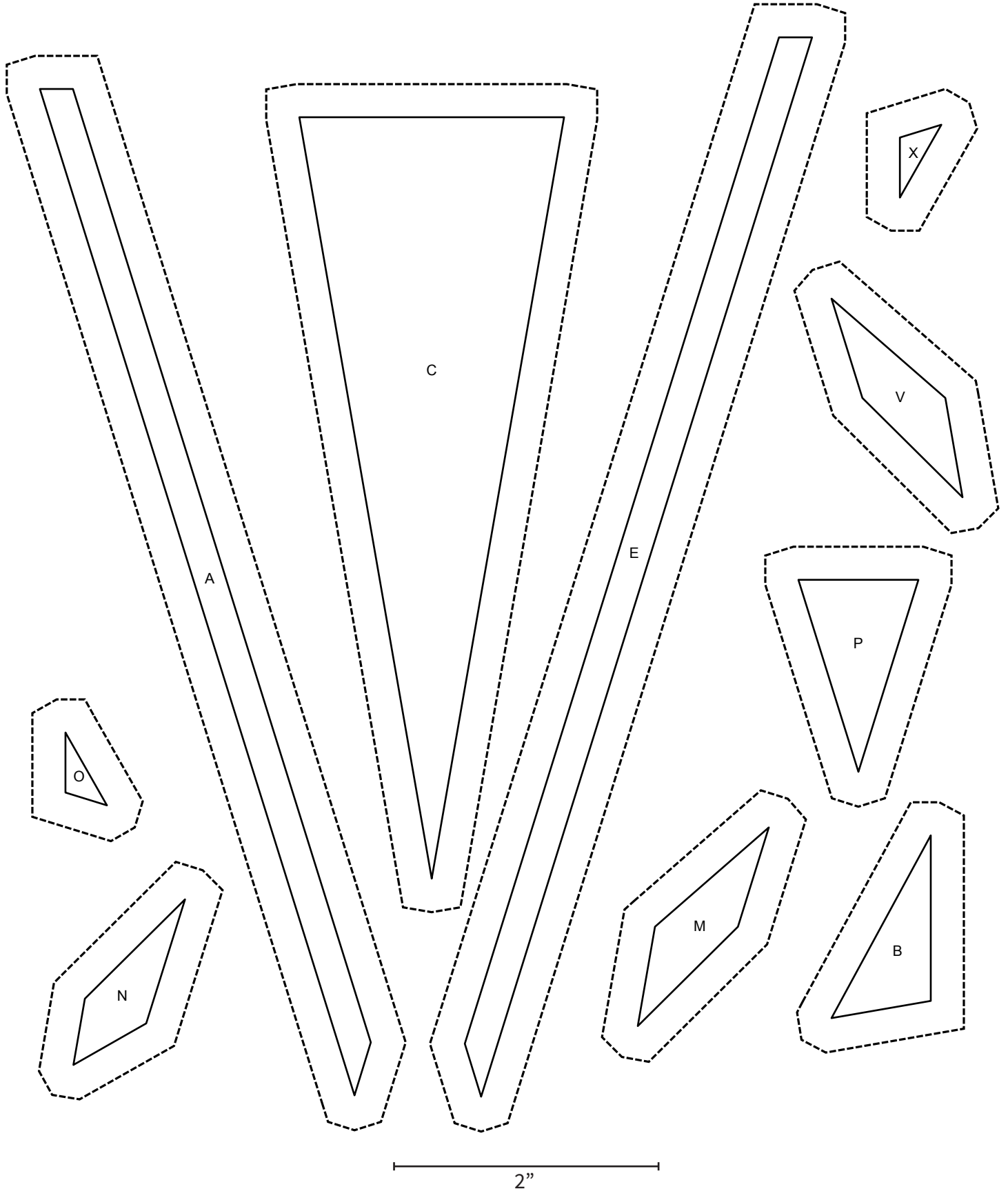

## The Jane Stickle Quilt - Block BT3



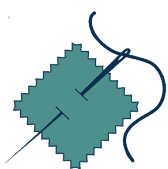

### What you need:

Patches	Quantity/size
B/C	assigned by EQ but not used
A	(1 each) 1½" x 6" - navy
D/E/F	(5) 1½" x 2" - light blue (5) 1½" x 2" - navy
G/H	(2) 1½" x 2" - navy
I/J/K	(4) 1½" x 1½" - light blue (2) 1½" x 1½" - navy
L/M/N/O	(3) 1½" x 2" - navy (2) 1½" x 2" - light blue
P/Q	(2) 1½" x 1½" - navy
R	(1 each) 1½" x 3"
S/T/U	(2) 1½" x 1½" - navy (1) 1½" x 1½" - light blue
V	(1) 2½" x 1½" - navy

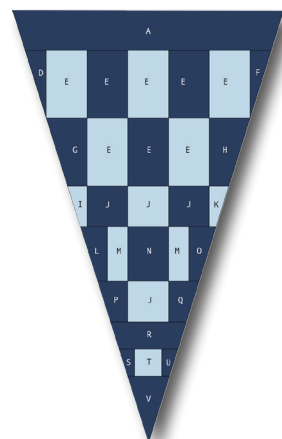

Hobbystash Colorway

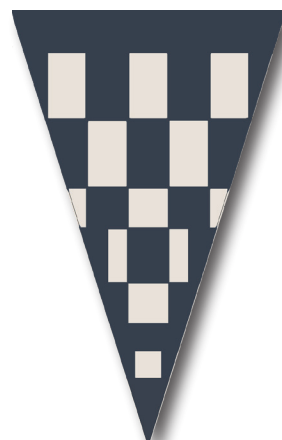

Jane Stickle Colorway

### Assembly:

- Using the templates provided on Page BT3-2, foundation piece each section.
- Join the sections together.

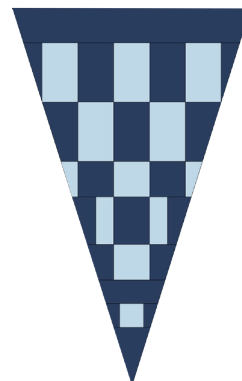
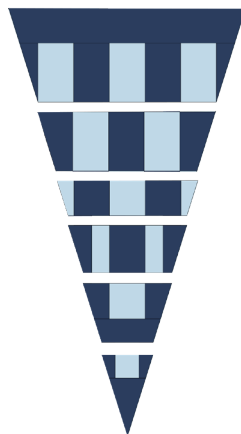



SET PRINTER TO "ACTUAL SIZE" WHEN PRINTING THIS PAGE.

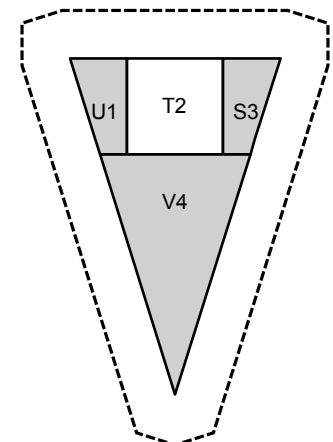
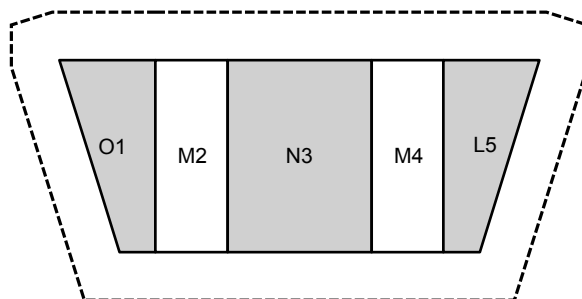
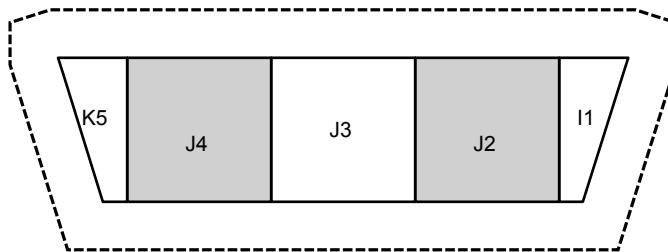
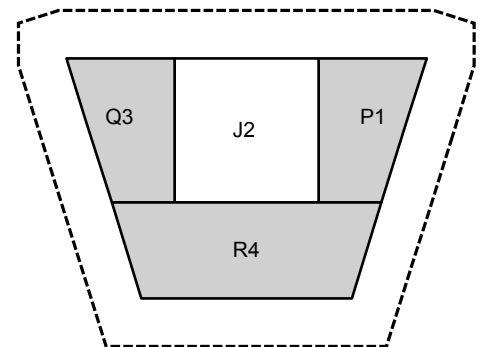
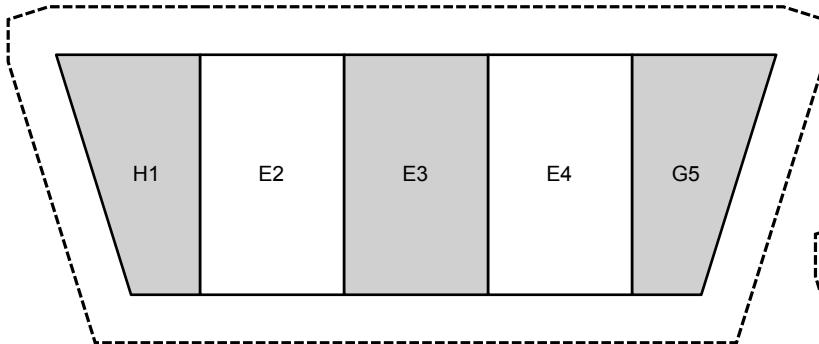
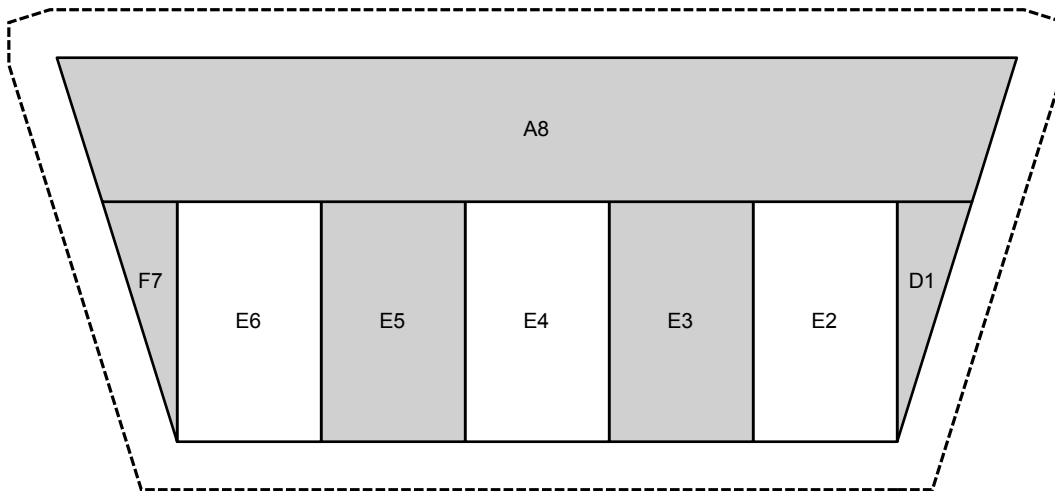

2"

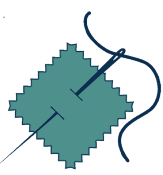

SET PRINTER TO "ACTUAL SIZE" WHEN PRINTING THIS PAGE.

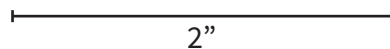
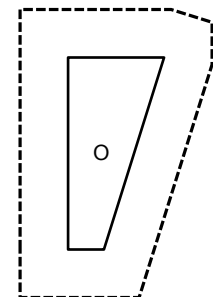
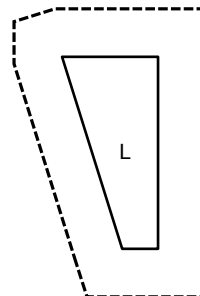
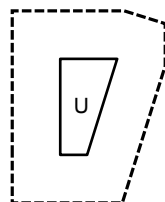
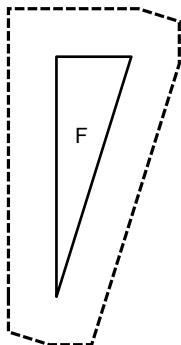
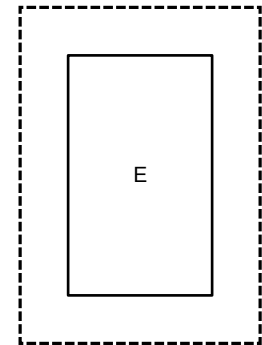
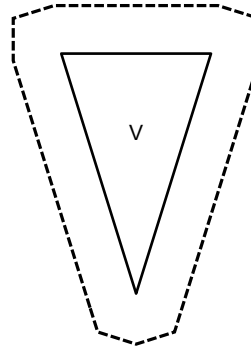
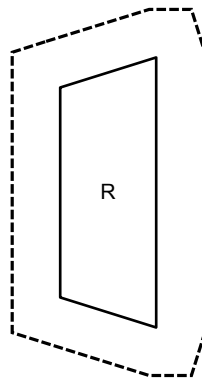
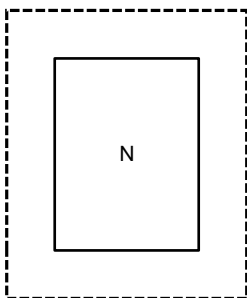
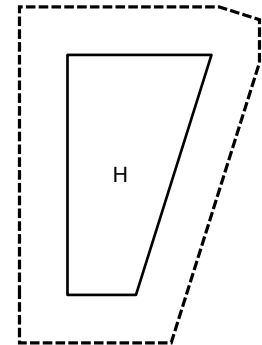
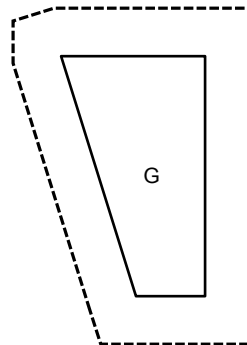
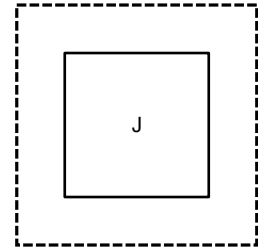
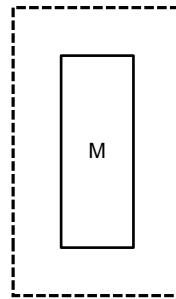
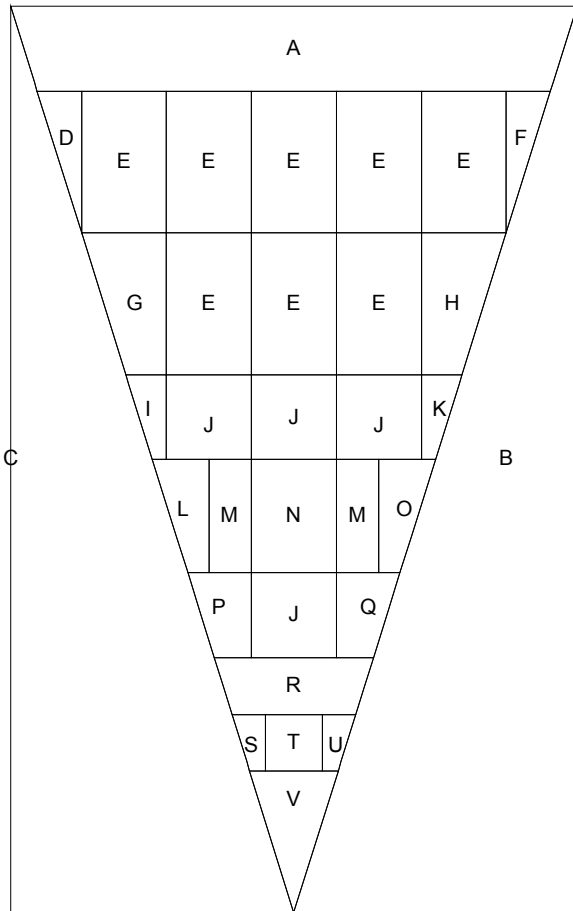

SET PRINTER TO "ACTUAL SIZE" WHEN PRINTING THIS PAGE.

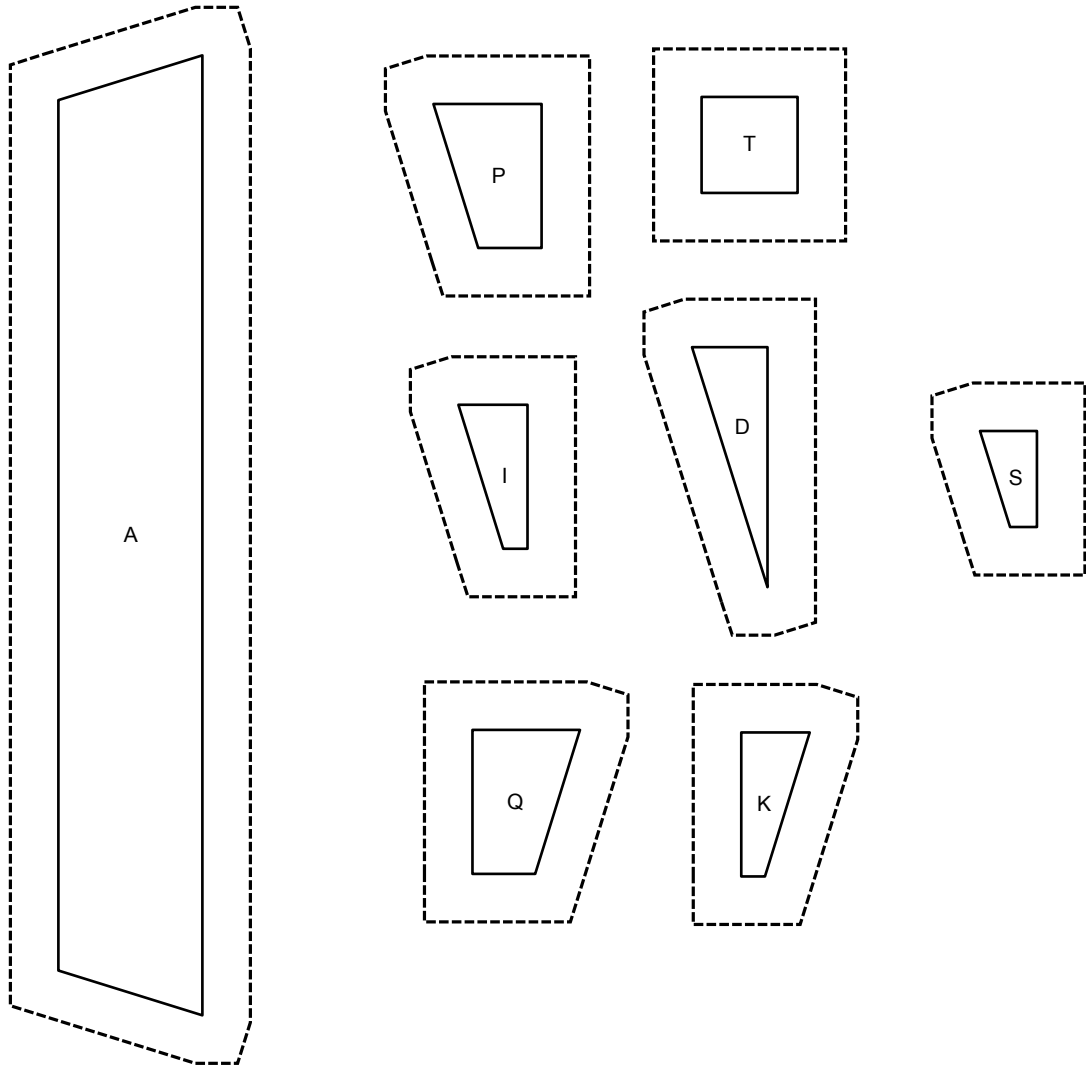



2"

## The Jane Stickle Quilt - Block BT4

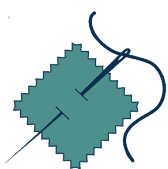



### What you need:

Patches	Quantity/size
A - R - X 	(3) 3¼" x 3¼" - light blue, cut twice diagonally (1) 3¼" x 3¼" - green, cut twice diagonally
B	(1) 2" x 3"
C - D	(2) 1¼" x 3" - green
E - Q	(2) 2" x 3½" - green
F - T	(2) 2" x 1" - green
G - N	(2) 2" x 2½" - green
H - I - Y - Z	(4) 1½" x 2" - green
J - K	(2) 1" x 3" - green
L - V	(2) 1½" x 2"
M - W	(2) 1¼" x 1½" - green
O 	(1) 2" x 2" - green, cut once diagonally
P - S	(2) 1½" x 2"
U	(1) 1¼" x 4"

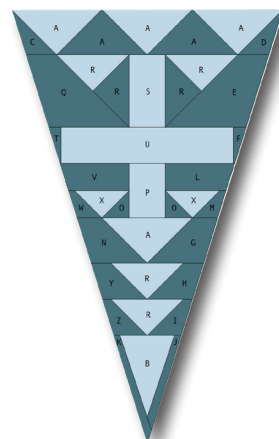

*Hobbystash Colorway*

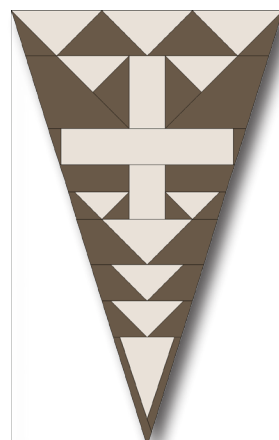

*Jane Stickle Colorway*

### Assembly:

- Using the templates provided on Pages BT4-2 and BT4-3, foundation piece each section.
- Join the sections together.

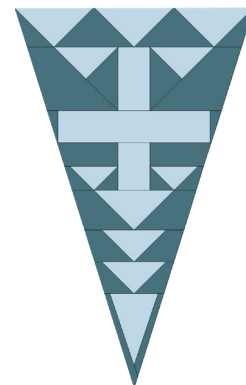
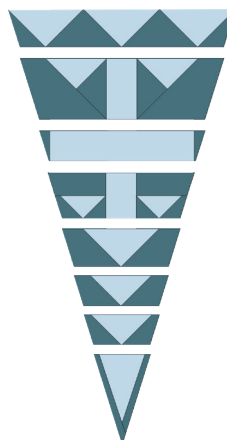



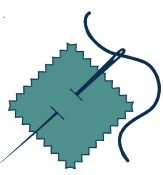

SET PRINTER TO "ACTUAL SIZE" WHEN PRINTING THIS PAGE.

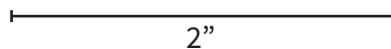
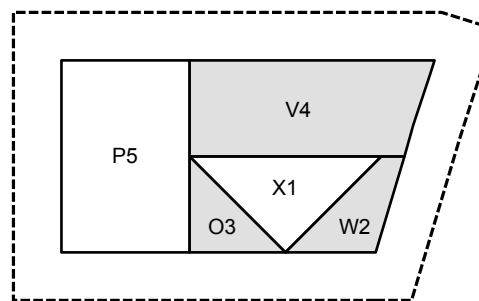
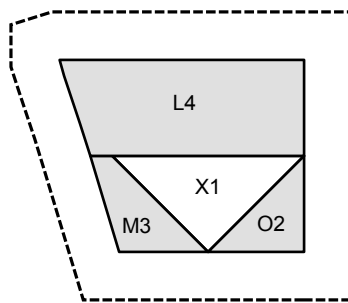
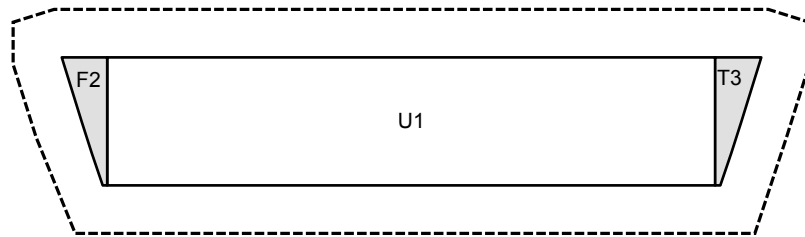
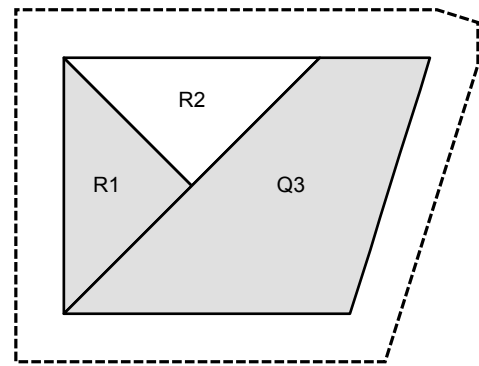
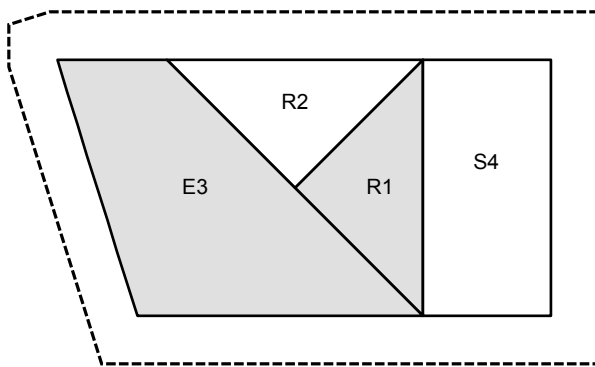
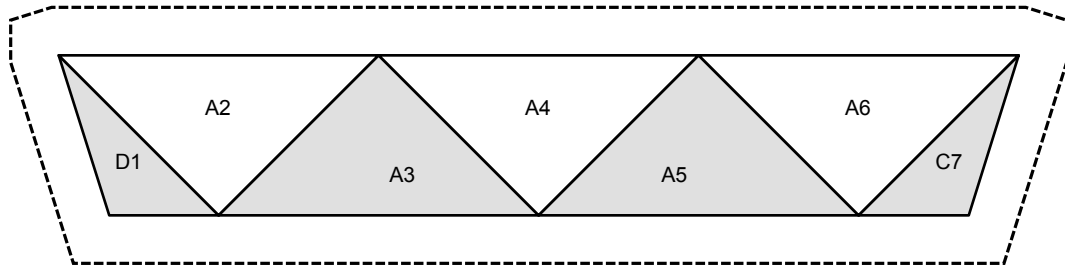

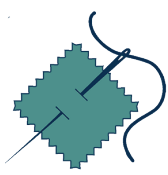

SET PRINTER TO "ACTUAL SIZE" WHEN PRINTING THIS PAGE.

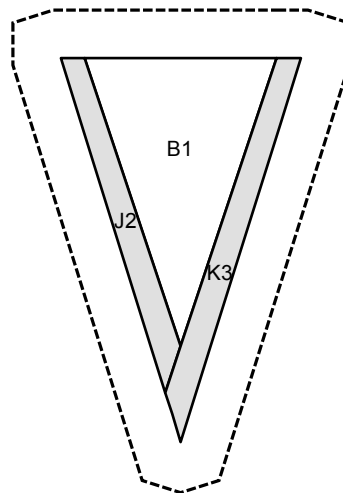
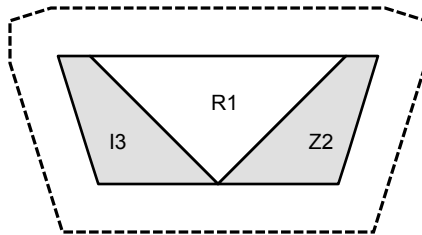
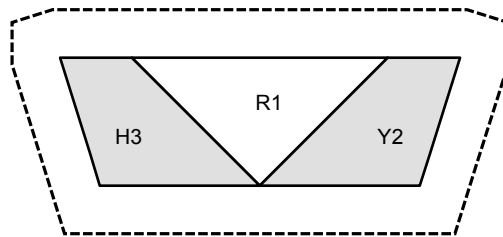
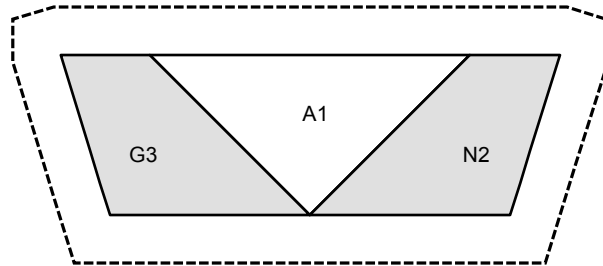

2"

SET PRINTER TO "ACTUAL SIZE" WHEN PRINTING THIS PAGE.

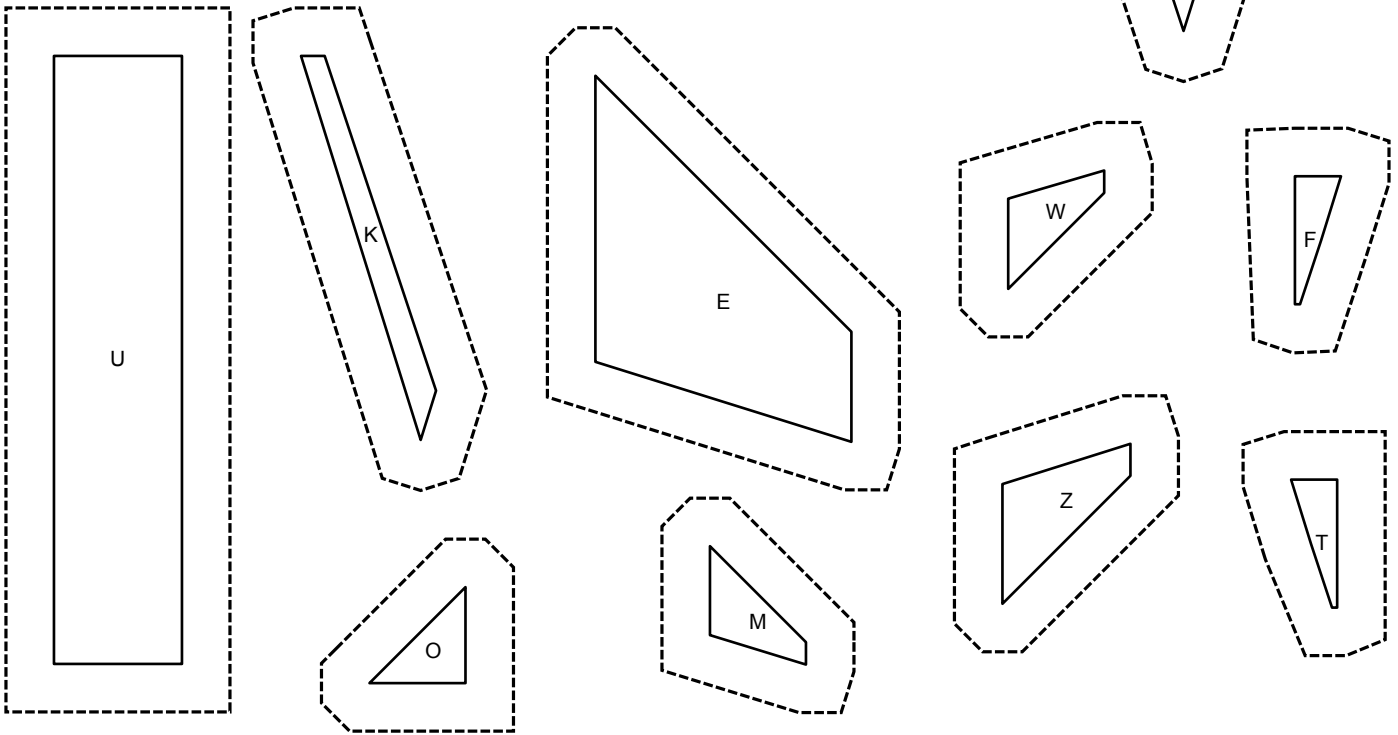
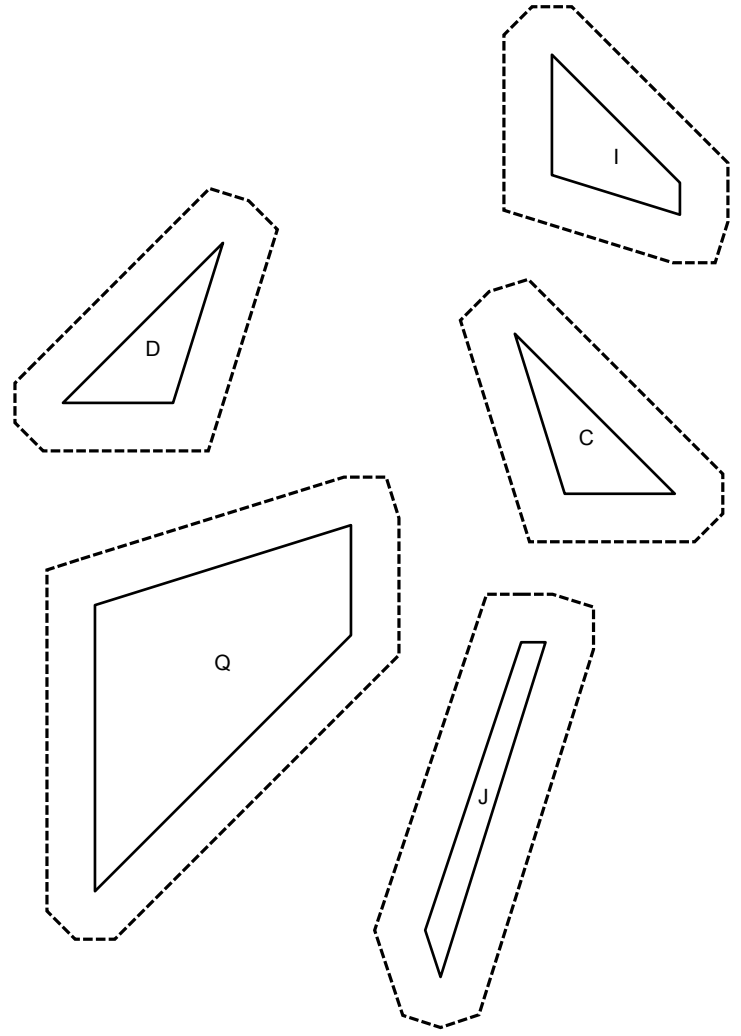
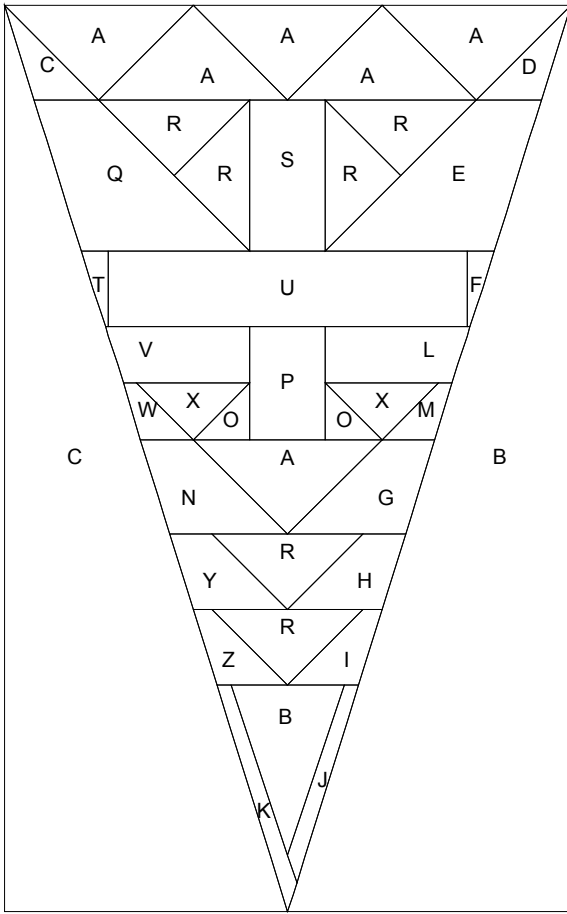

2"

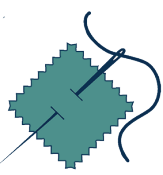

SET PRINTER TO "ACTUAL SIZE" WHEN PRINTING THIS PAGE.

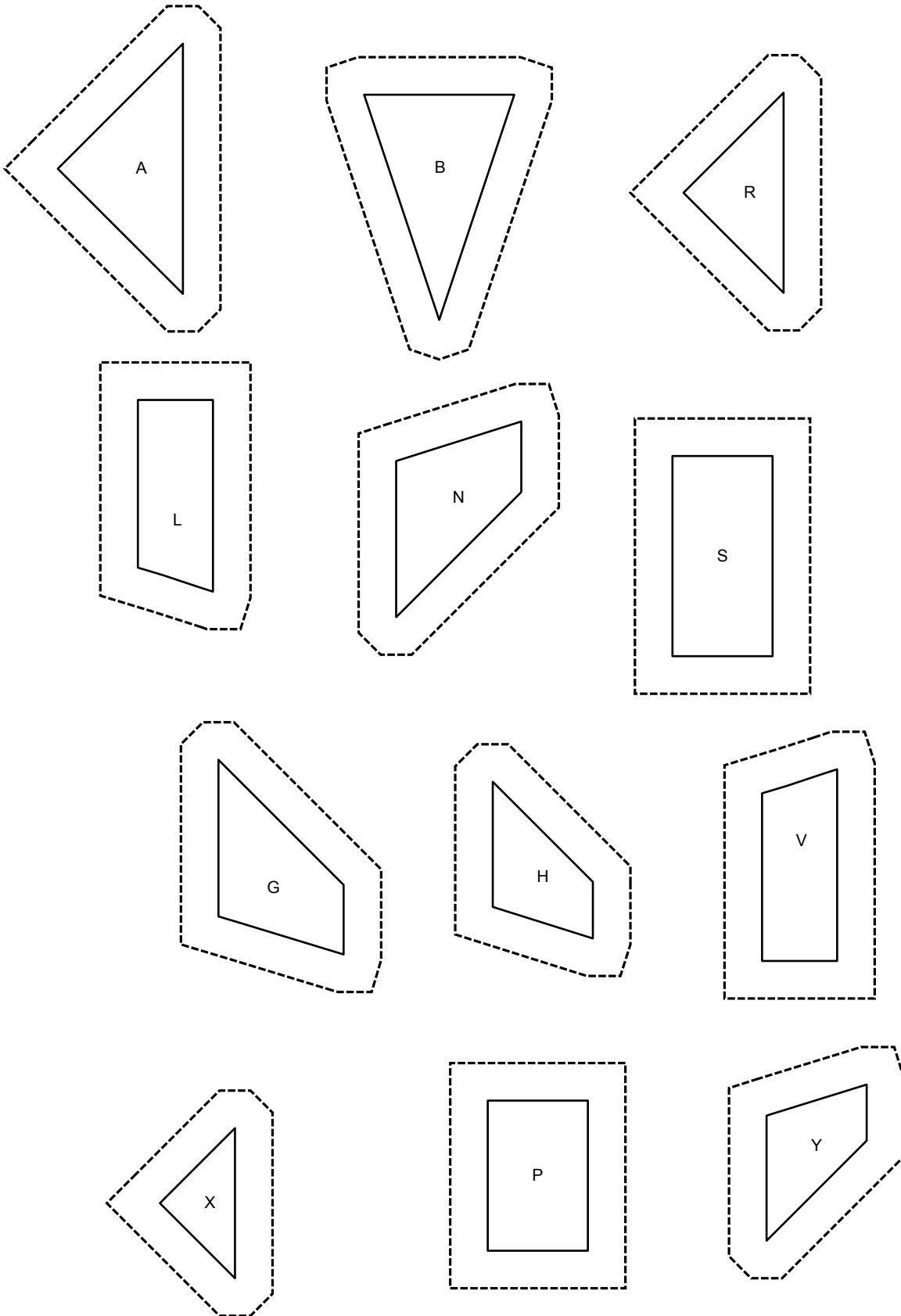

2"

## The Jane Stickle Quilt - Block BT5





### What you need:

Patches	Quantity/size
D-E	assigned by EQ but not used
A-C	(2) 1½" x 8" - navy
B	(10) 2¾" x 2" - light blue (6) 2¾" x 2" - navy
F-G	(2) 1" x 2½" - navy
H	(1) 1½" x 2" - light blue

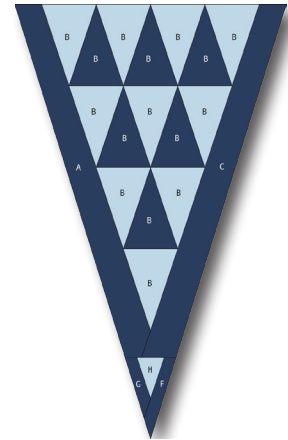

Hobbystash Colorway

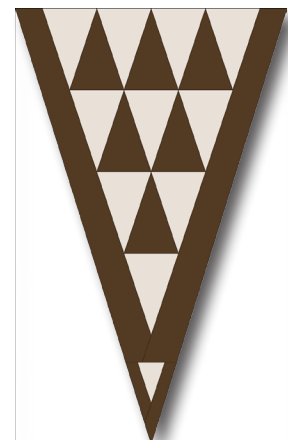

Jane Stickle Colorway

### Assembly:

- Using the templates provided on Page BT5-2, foundation piece each section.
- Join the sections together.



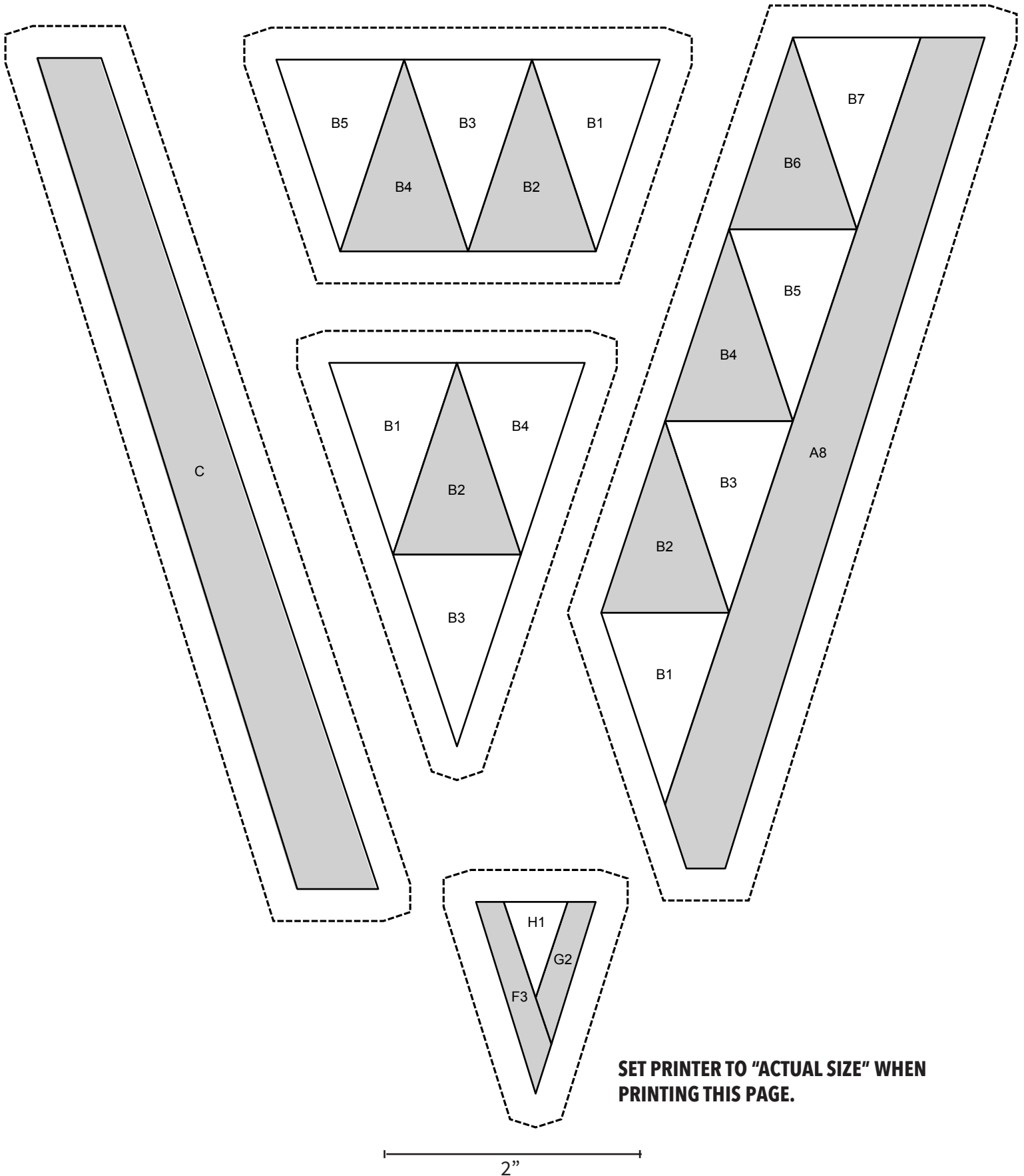

**SET PRINTER TO "ACTUAL SIZE" WHEN  
PRINTING THIS PAGE.**

SET PRINTER TO "ACTUAL SIZE" WHEN PRINTING THIS PAGE.

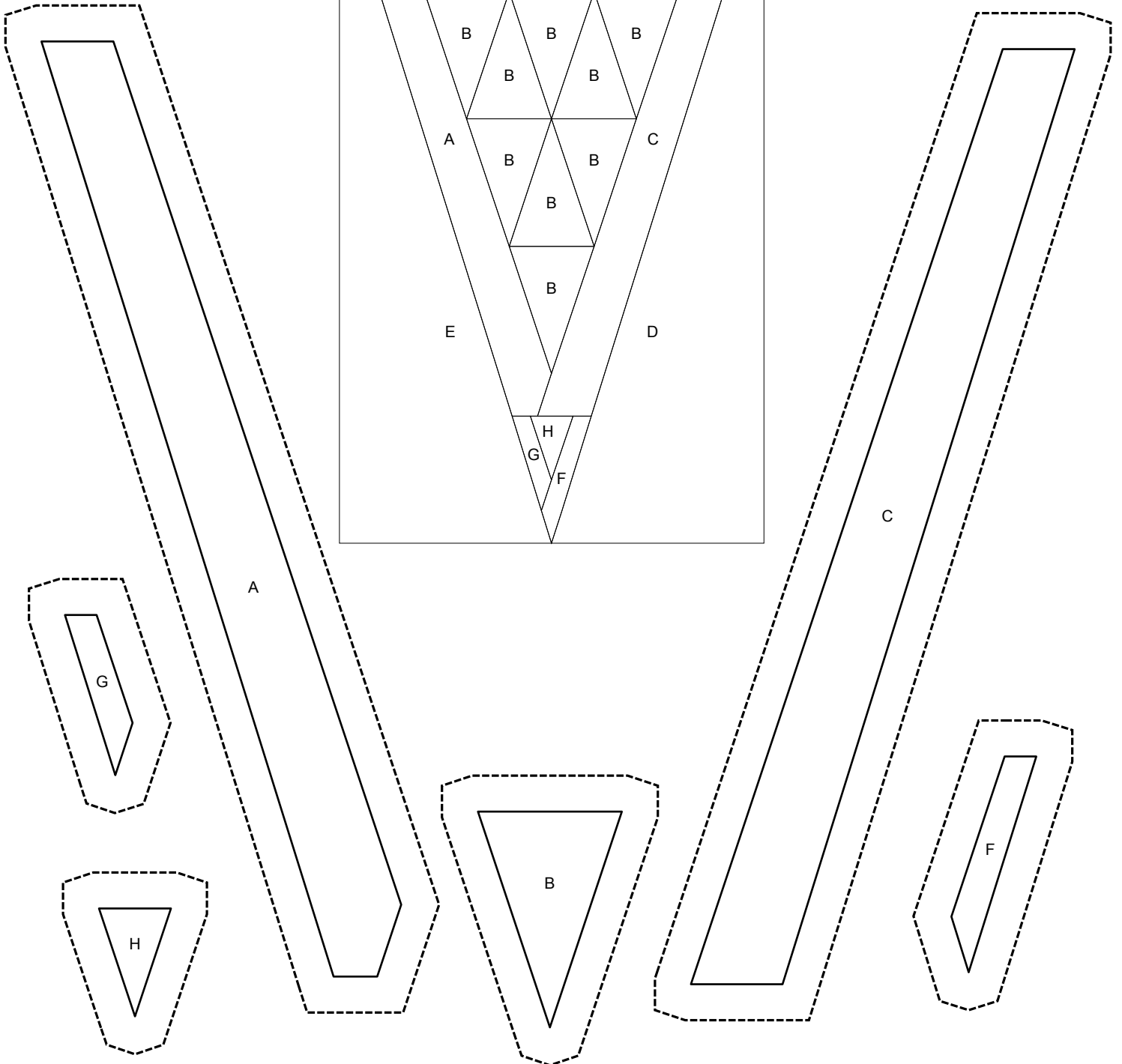
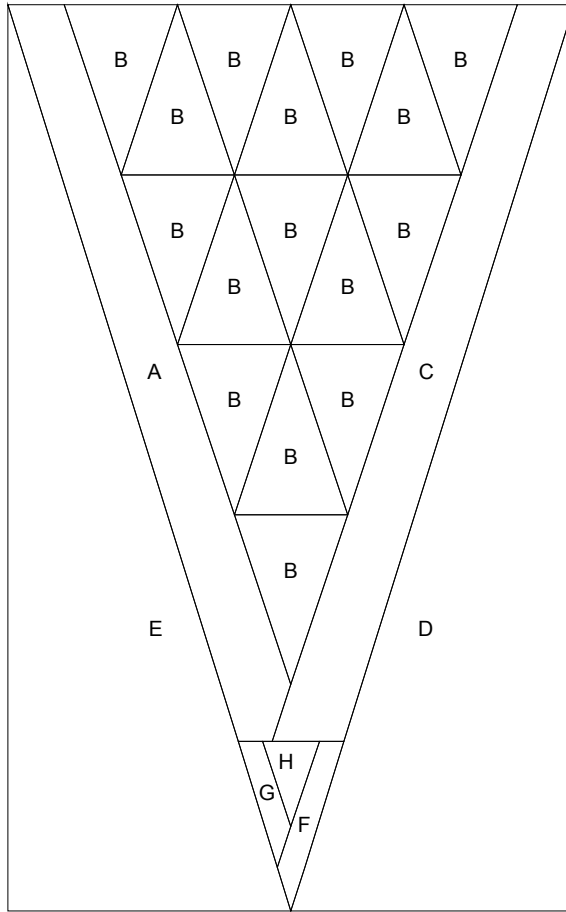

2"

# The Jane Stickle Quilt - Block BT6



### What you need:

Patches	Quantity/size
B - C	assigned by EQ but not used
A	(1) 2½" x 6" - light blue
D - F	(2) 2" x 3" - green
E - O - P	(10) 2" x 2" - green
G - H	(2) 2" x 4" - green
I	(2) 2" x 2½" - green
J	(1) 2 x 2½" - green
K - L	(2) 1½" x 2½" - green
M - N	(5) 1½" x 2" - light blue
Q	(1) 1½" x 1½" - light blue

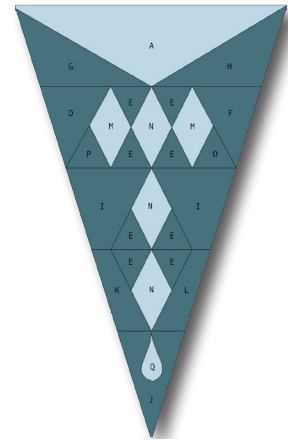

*Hobbystash Colorway*

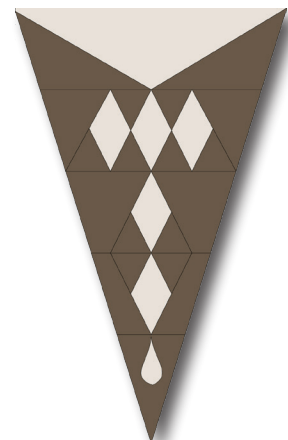

*Jane Stickle Colorway*

### Assembly:

1. Using the templates provided on Page BT6-2, foundation piece each section.
2. Join the sections together.
3. Applique teardrop to bottom triangle.

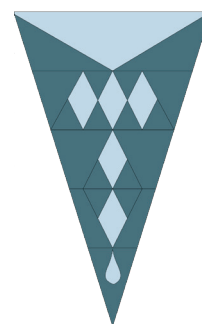
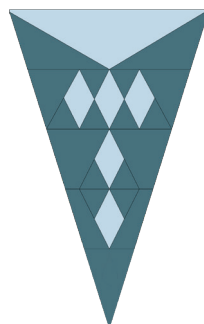
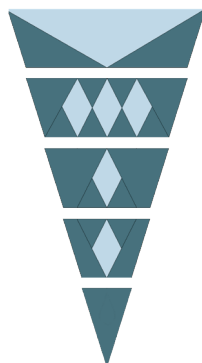

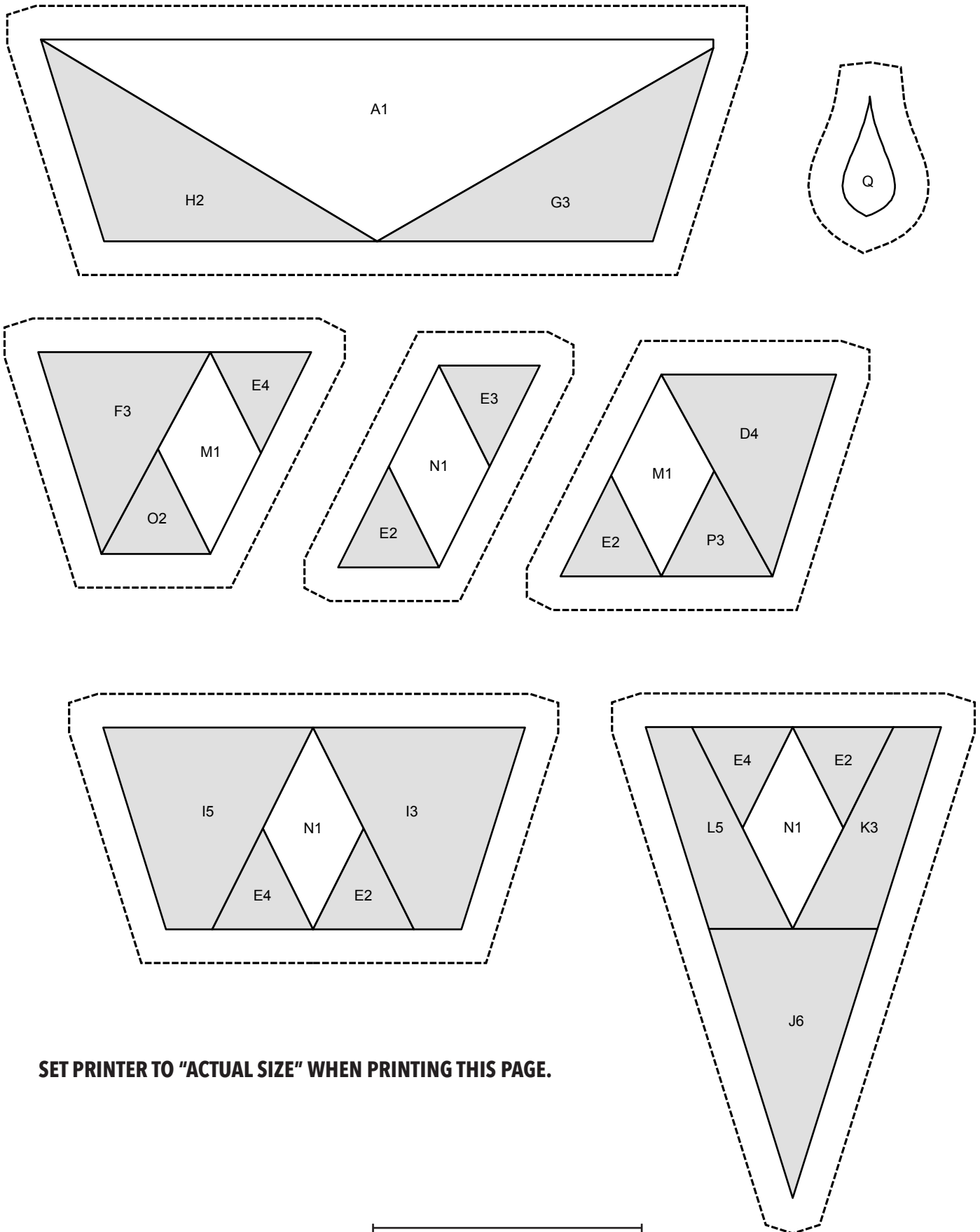

SET PRINTER TO "ACTUAL SIZE" WHEN PRINTING THIS PAGE.

SET PRINTER TO "ACTUAL SIZE" WHEN PRINTING THIS PAGE.

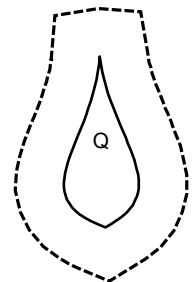
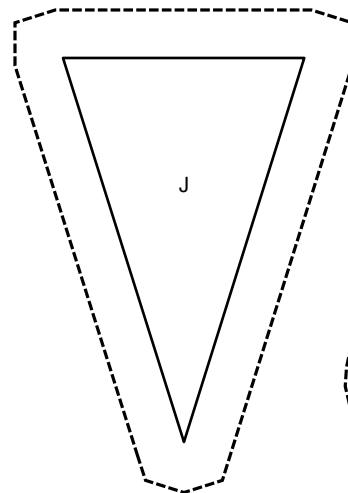
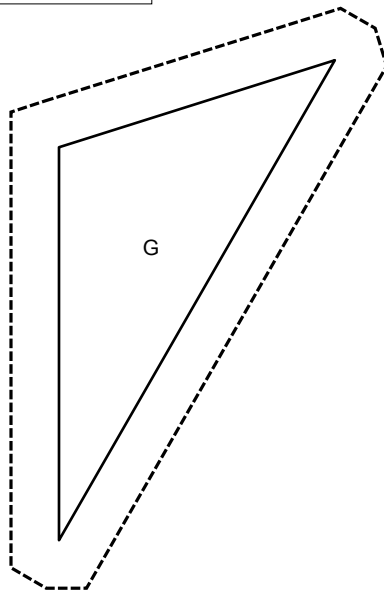
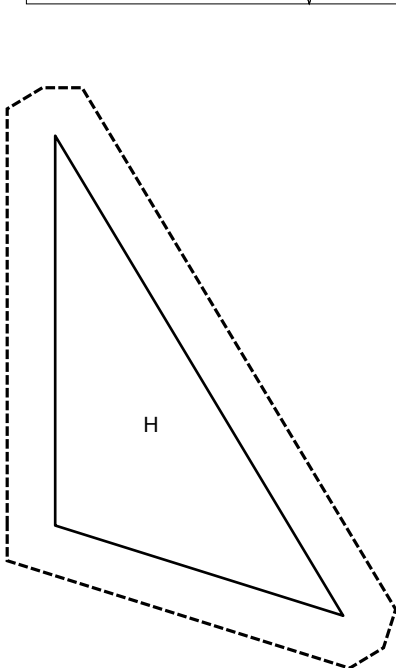
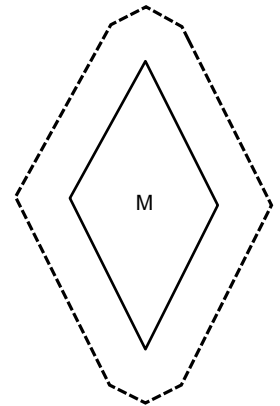
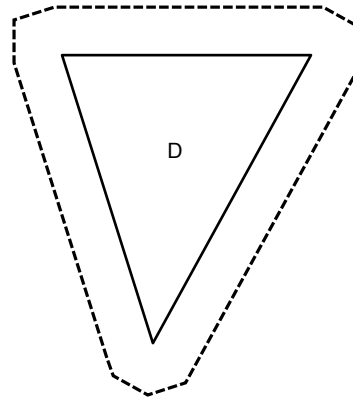
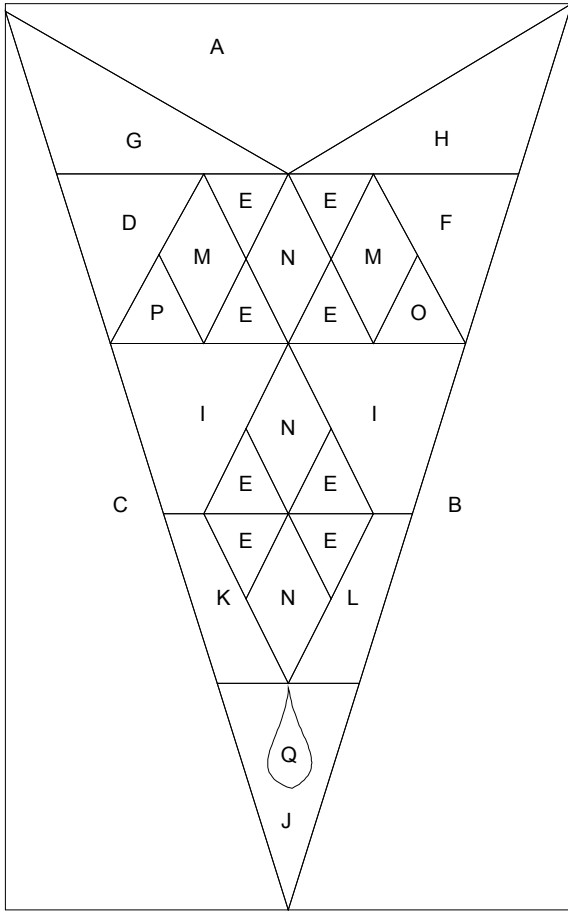

2"

SET PRINTER TO "ACTUAL SIZE" WHEN PRINTING THIS PAGE.

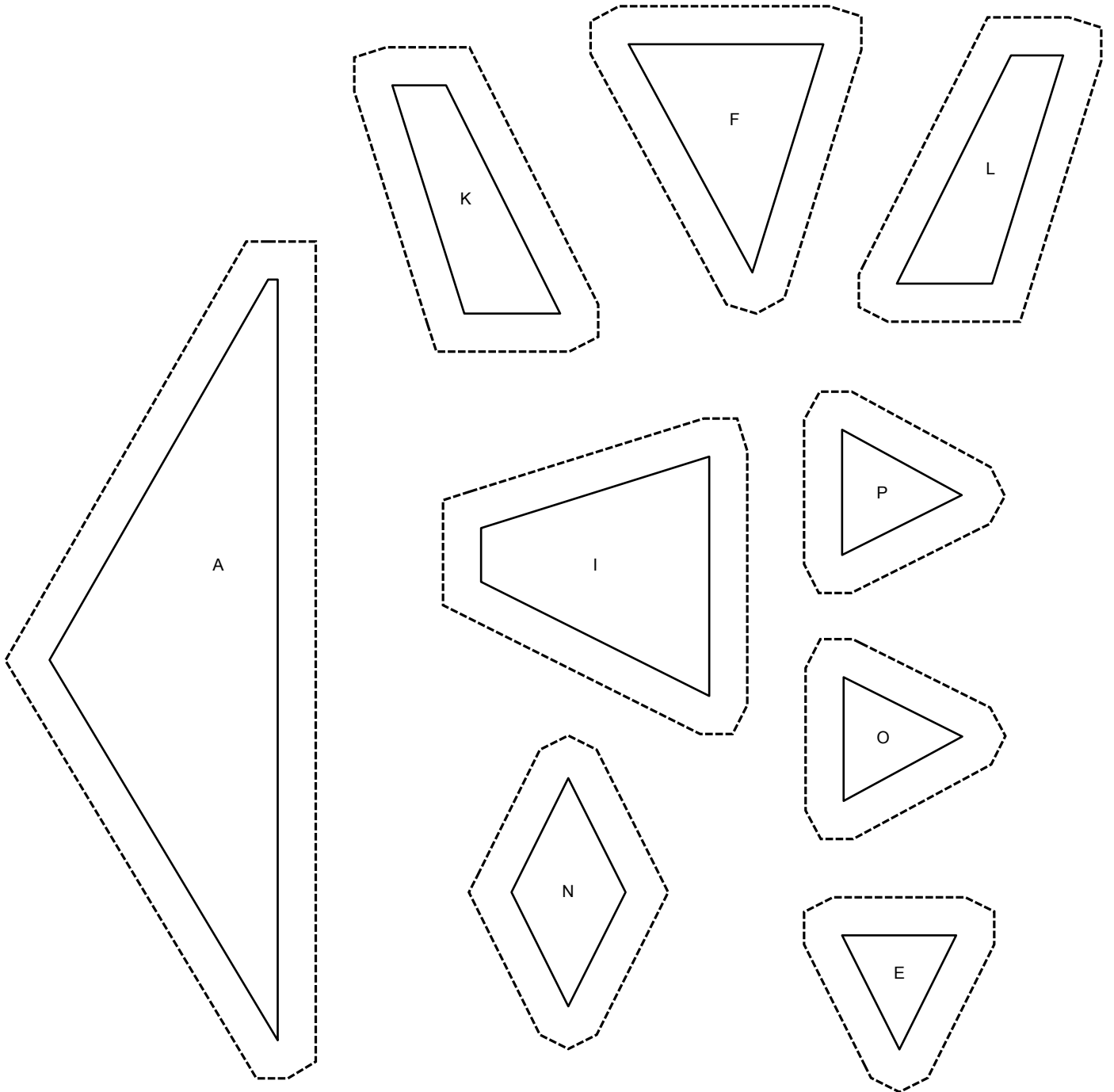



## The Jane Stickle Quilt - Block BT7



### What you need:

Patches	Quantity/size
<b>F - G</b>	<b>assigned by EQ but not used</b>
A - E	(2) 1½" x 7½" - navy
B - D	(2) 1½" x 2½" - navy
C	(1) 3" x 5½" - light blue
H - J	(2) 1½" x 2" - navy
I	(1) 2" x 2½" - navy
K - T	(2) 1½" x 2" - light blue
L - P - R	(2) 1½" x 2½" - light blue (1) 1½" x 2½" - navy
M - N - O - Q - S	(4) 2" x 2½" - navy (2) 2" x 2½" - light blue
U	(1) 1½" x 1½" - light blue
V	(2) 1½" x 2" - light blue

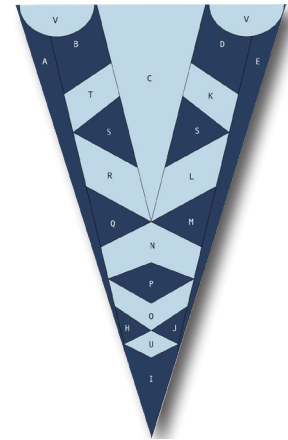

*Hobbystash Colorway*



*Jane Stickle Colorway*

### Assembly:

- Using the templates provided on Page BT7-2 and BT7-3, foundation piece each section.
- Join the sections together.
- Applique half circles to top of triangle.

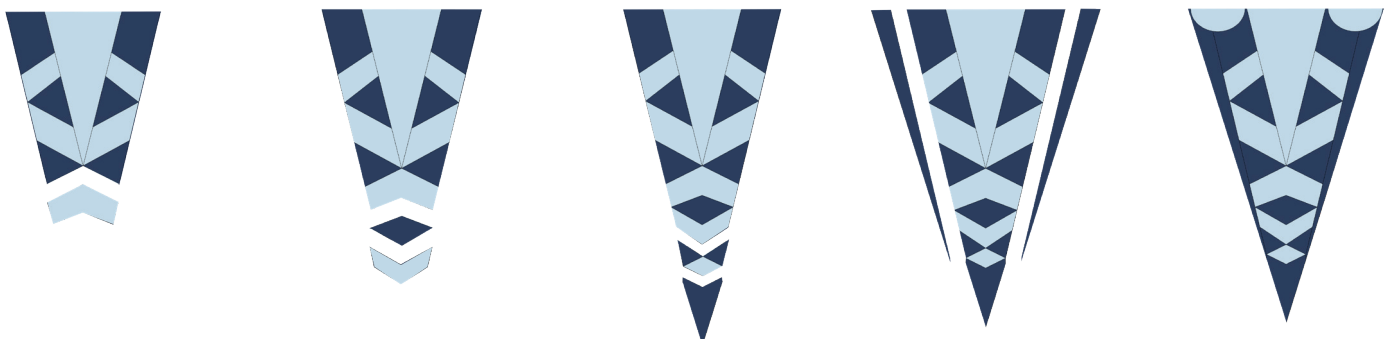

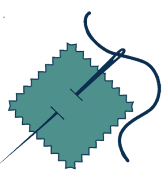

SET PRINTER TO "ACTUAL SIZE" WHEN PRINTING THIS PAGE.

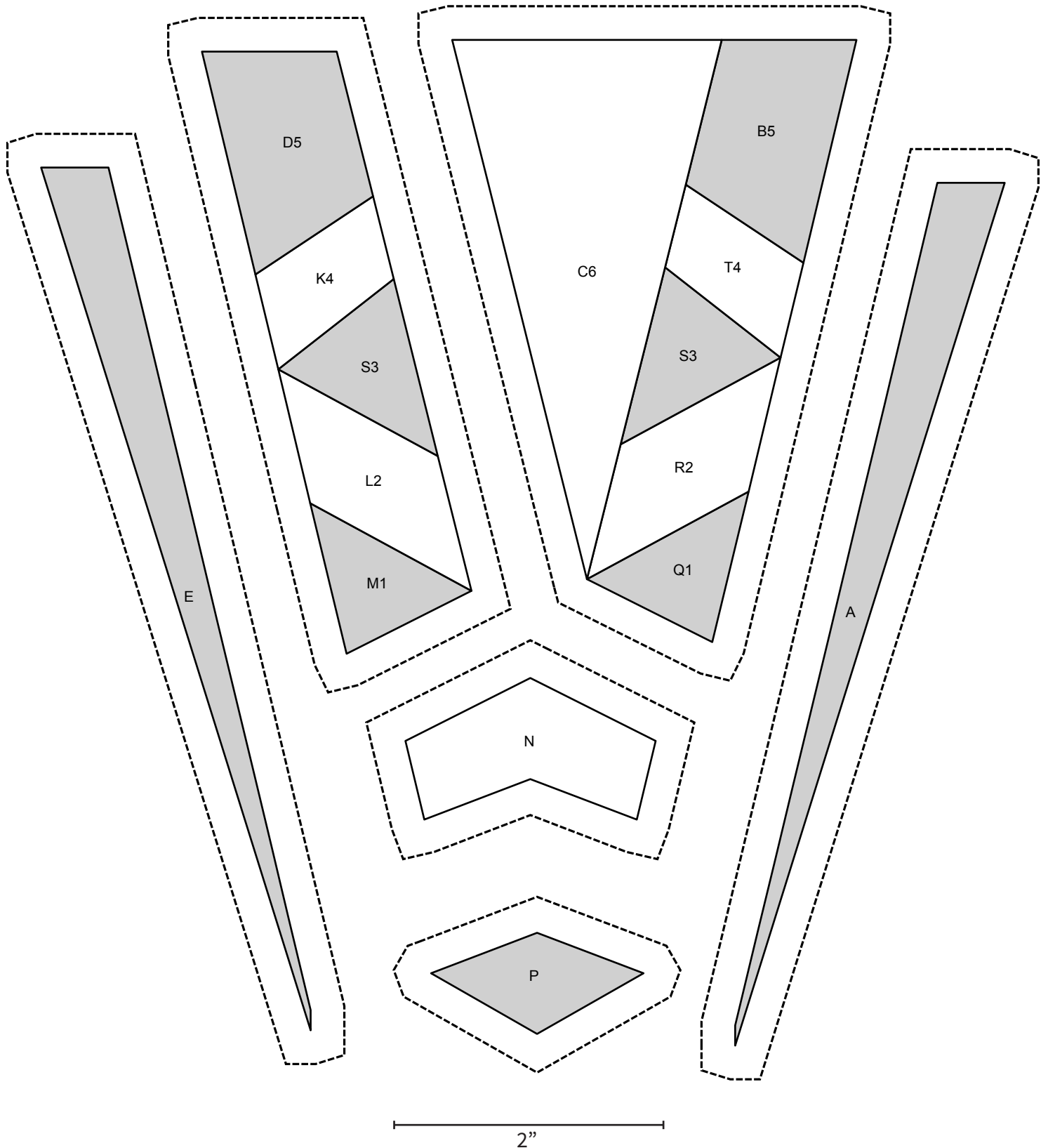

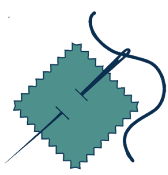

SET PRINTER TO "ACTUAL SIZE" WHEN PRINTING THIS PAGE.

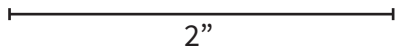
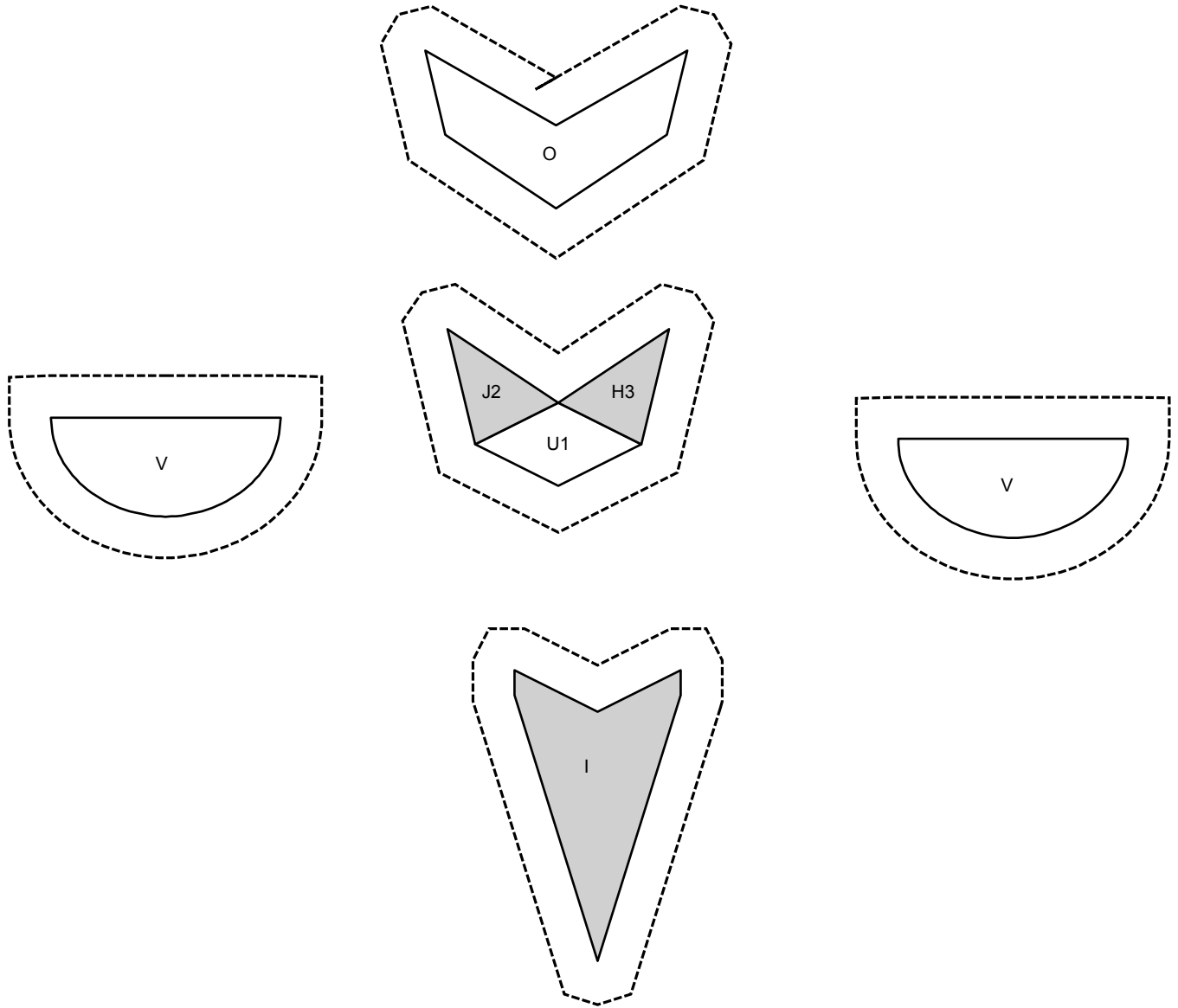

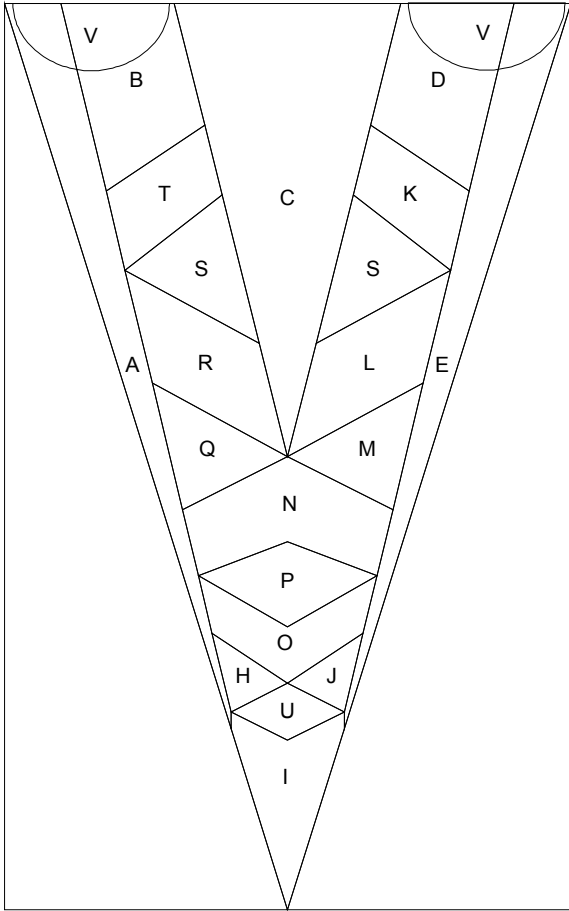

SET PRINTER TO "ACTUAL SIZE" WHEN PRINTING THIS PAGE.

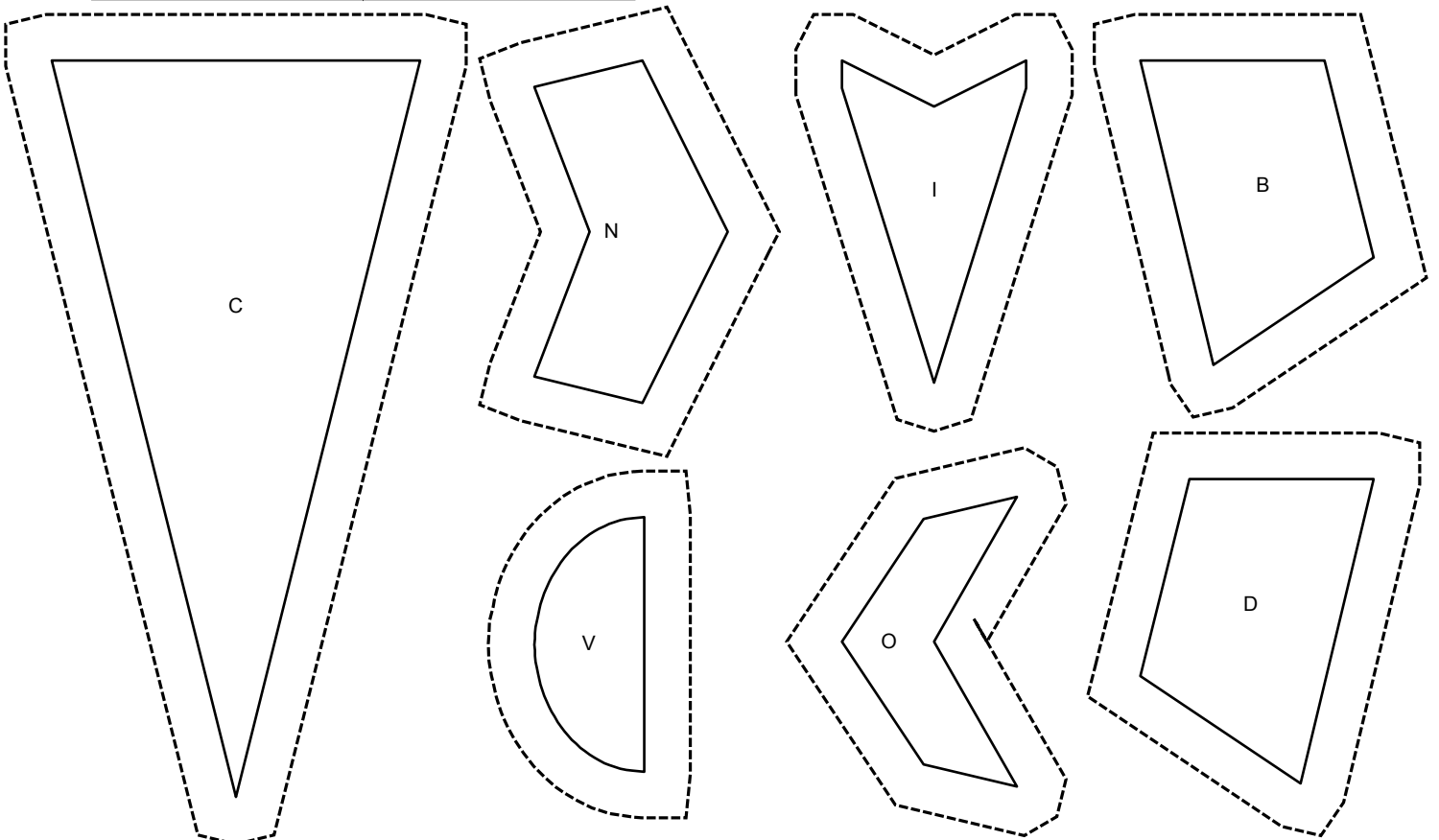
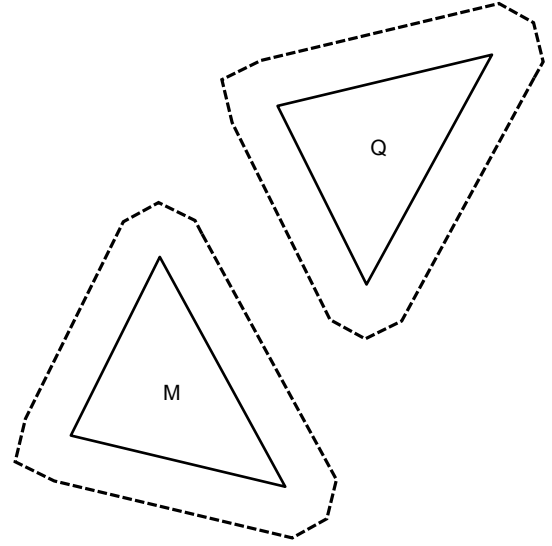
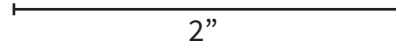

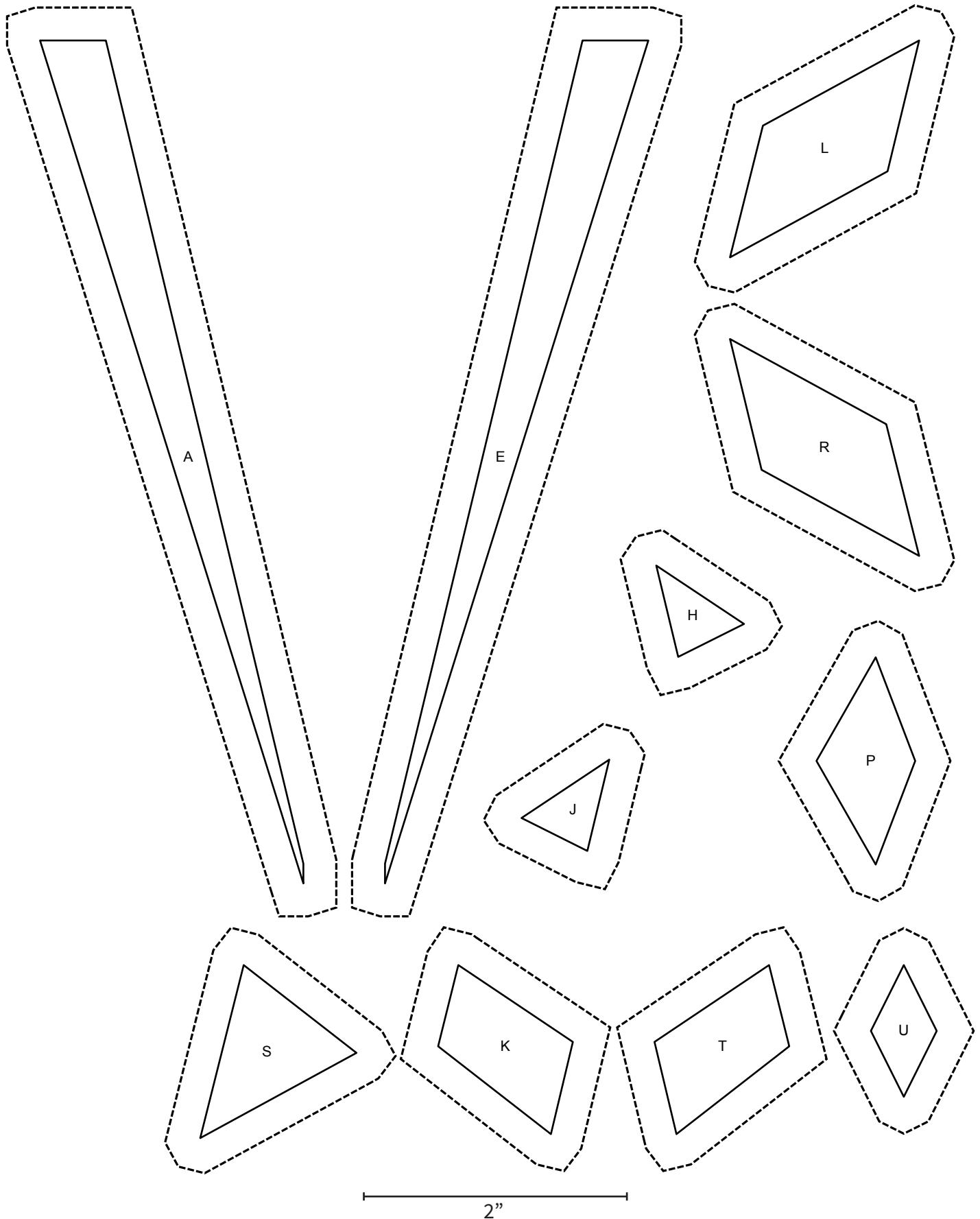

## The Jane Stickle Quilt - Block BT8



### What you need:

Patches	Quantity/size
G - H	assigned by EQ but not used
A - F	(2) 1½" x 5"
B - E	(2) 1½" x 2½"
C - D	(2) 2" x 3"
I - K	(2) 1½" x 4½"
J - M	(2) 1" x 2"
L	(1) 1½" x 2½"
N - P	(2) 1½" x 2½"
Q	(1) 2½" x 6"
O - R	(2) 1½" x 2"
S	(1) 1½" x 6"

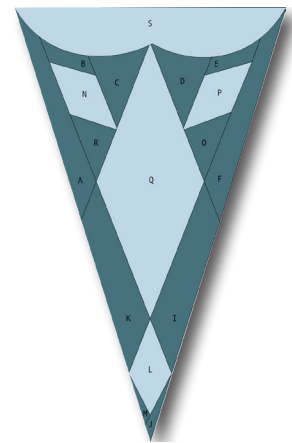

Hobbystash Colorway

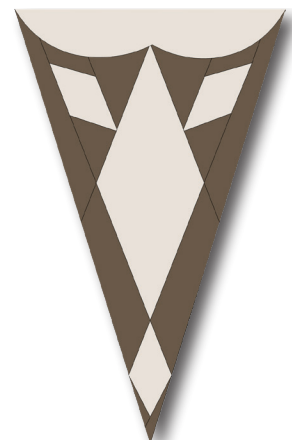

Jane Stickle Colorway

### Assembly:

1. Using the templates provided on Page BT8-2, foundation piece each section.
2. Join the sections together.
3. Applique half clover to top of triangle.

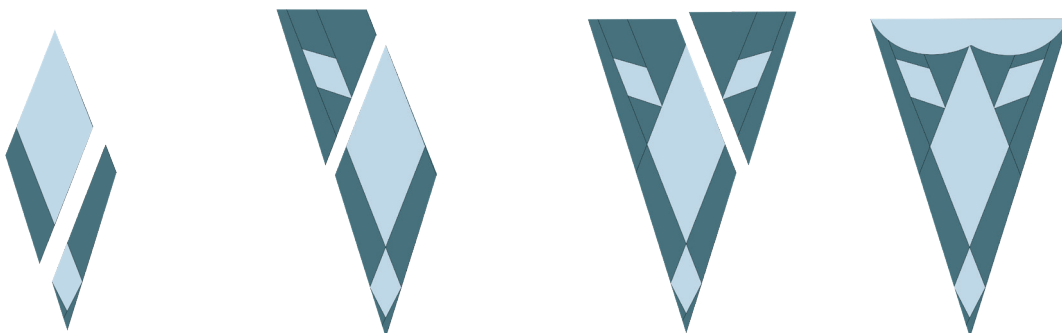



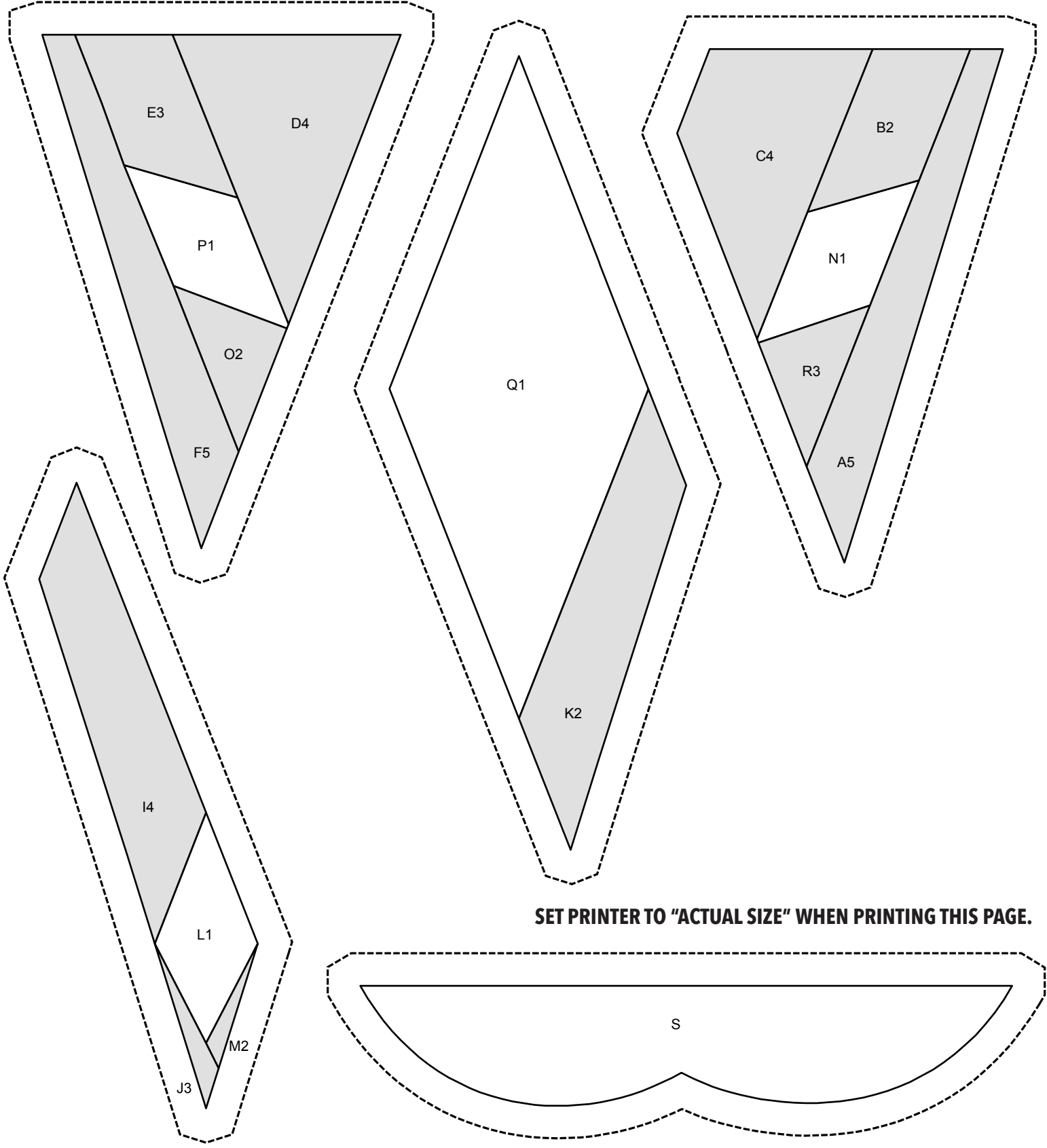

**SET PRINTER TO "ACTUAL SIZE" WHEN PRINTING THIS PAGE.**

2"

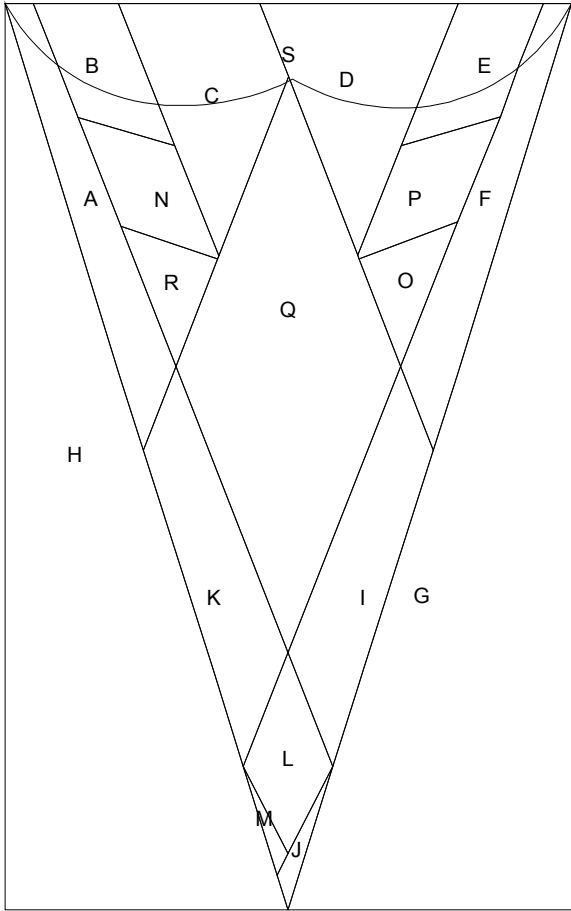

SET PRINTER TO "ACTUAL SIZE" WHEN PRINTING THIS PAGE.

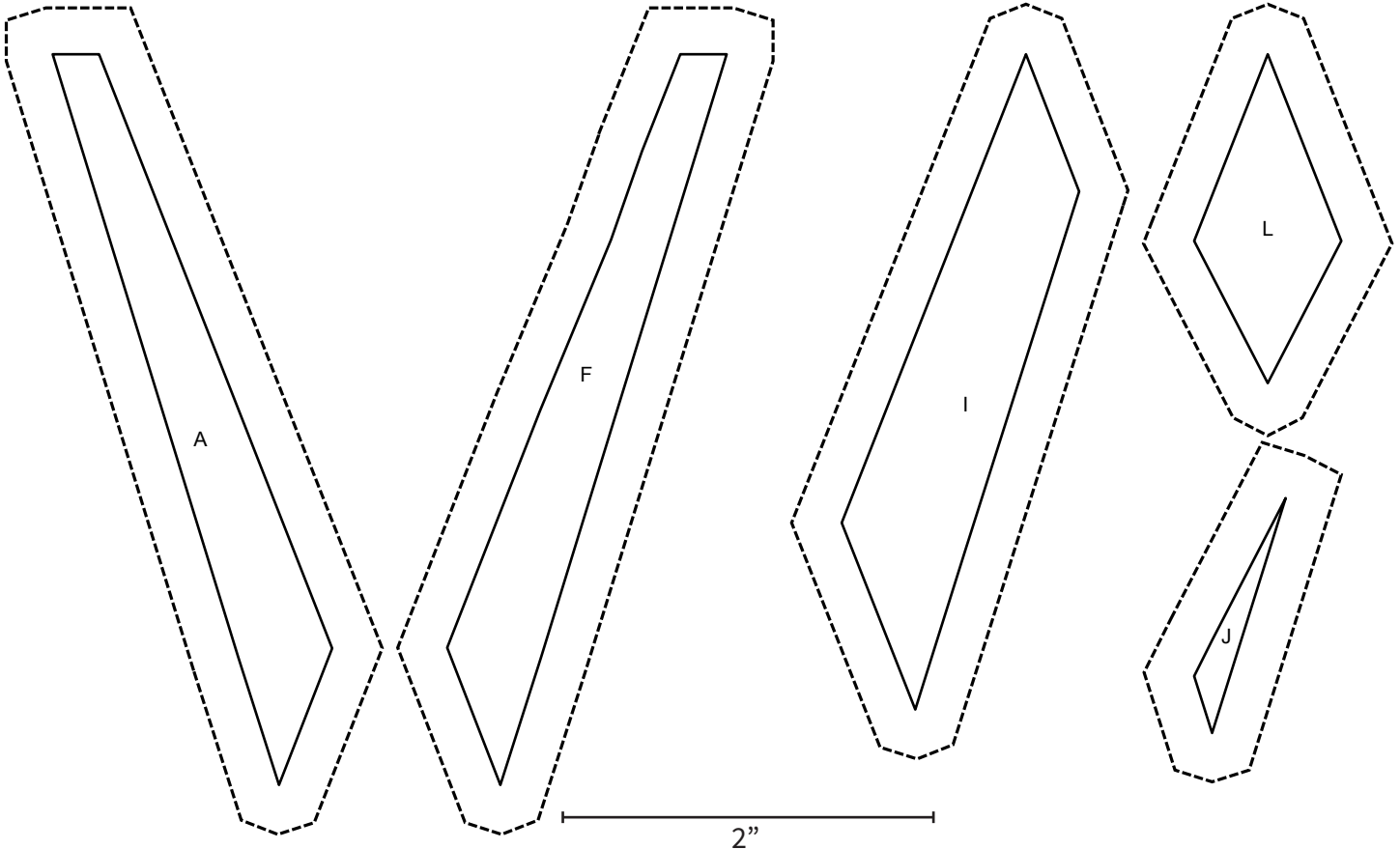
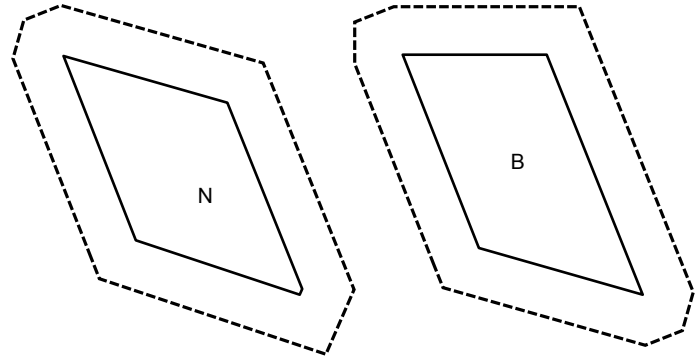

SET PRINTER TO "ACTUAL SIZE" WHEN PRINTING THIS PAGE.

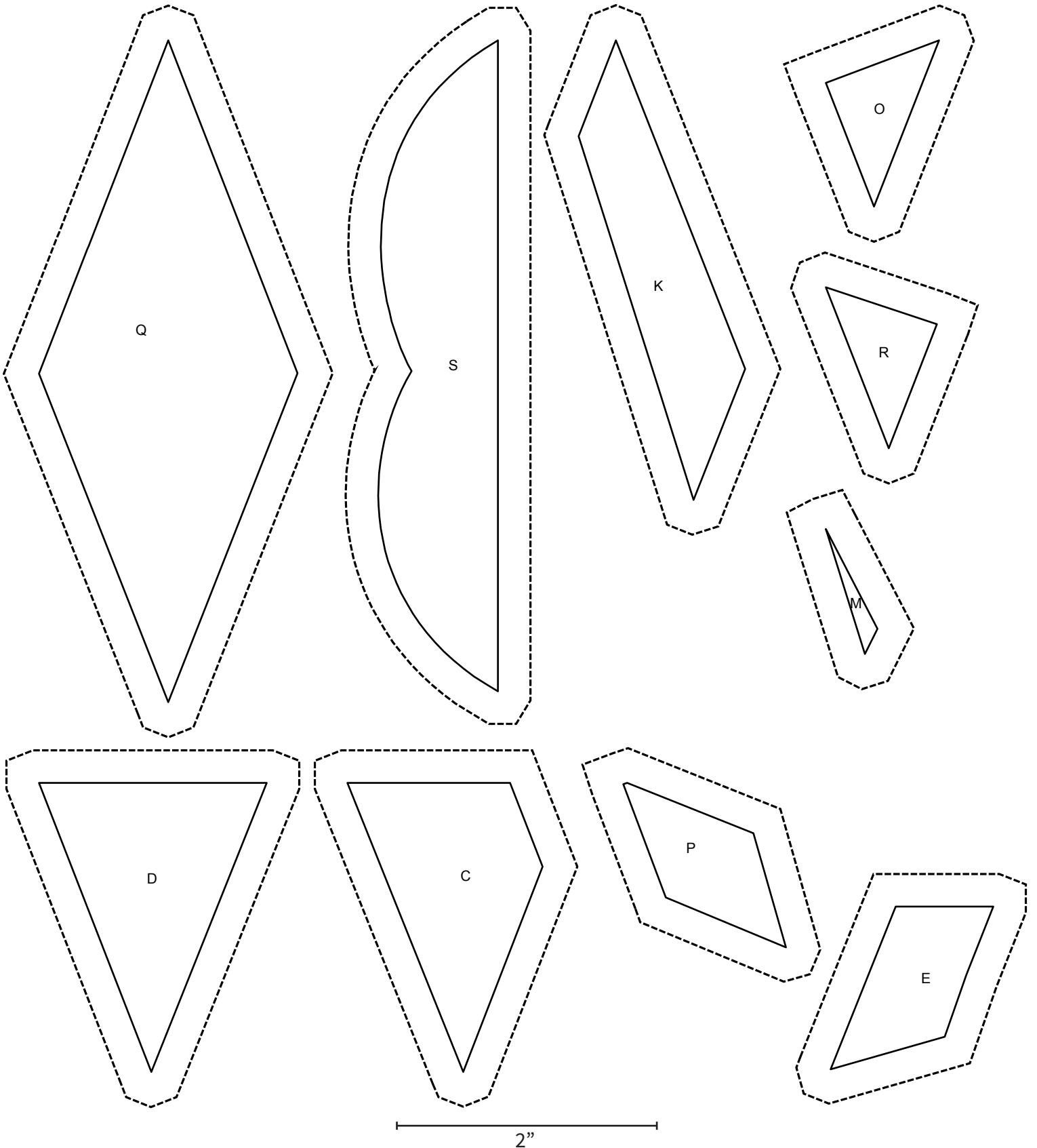

## The Jane Stickle Quilt - Block BT9



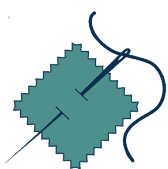

### What you need:

Patches	Quantity/size
B - C	assigned by EQ but not used
A	(1) 4" x 6½" - light blue
D - J	(2) 2½" x 6" - navy
E	(1) 2" x 3½" - light blue
F - H	(2) 2" x 3½" - navy
G - I	(2) 1½" x 5½" - navy
K	(1) 2" x 3½" - light blue

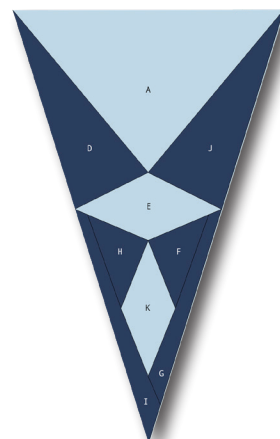

*Hobbystash Colorway*

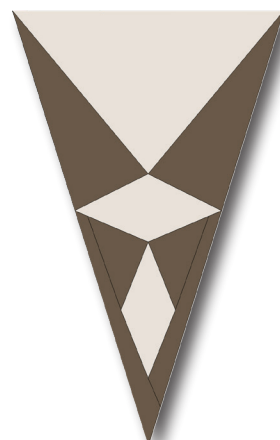

*Jane Stickle Colorway*

### Assembly:

1. Using the templates provided on Page BT9-2, foundation piece each section.
2. Join the sections together.

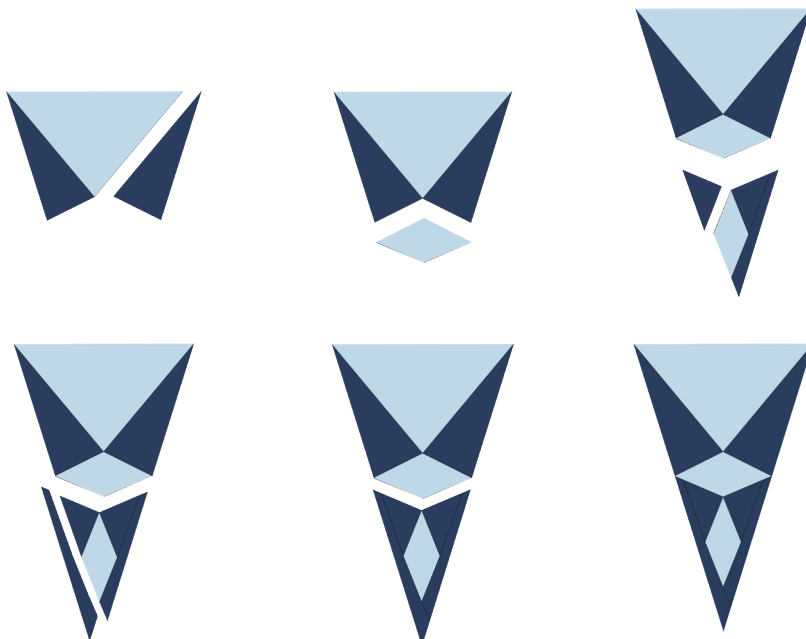

SET PRINTER TO "ACTUAL SIZE" WHEN PRINTING THIS PAGE.

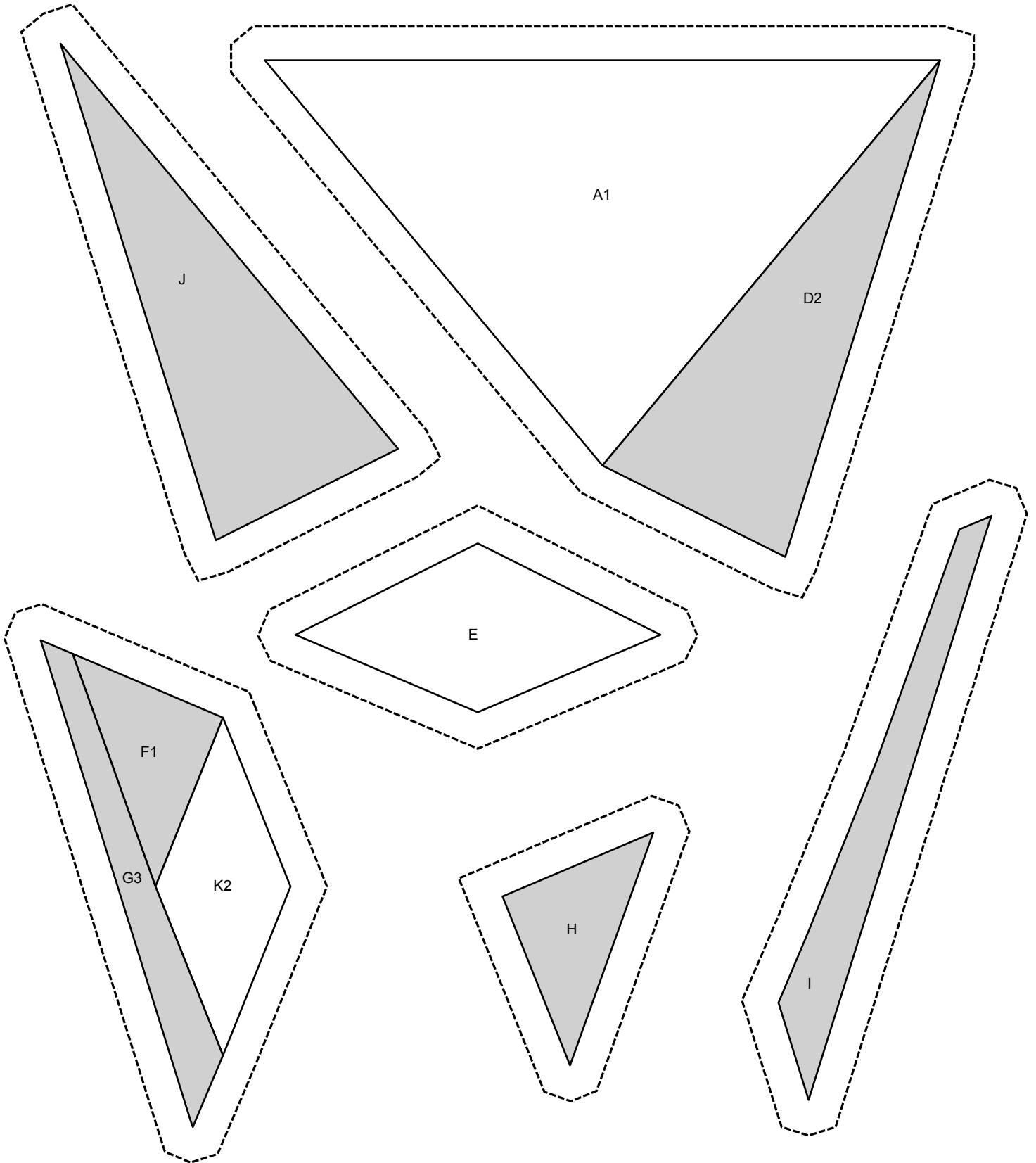

2"

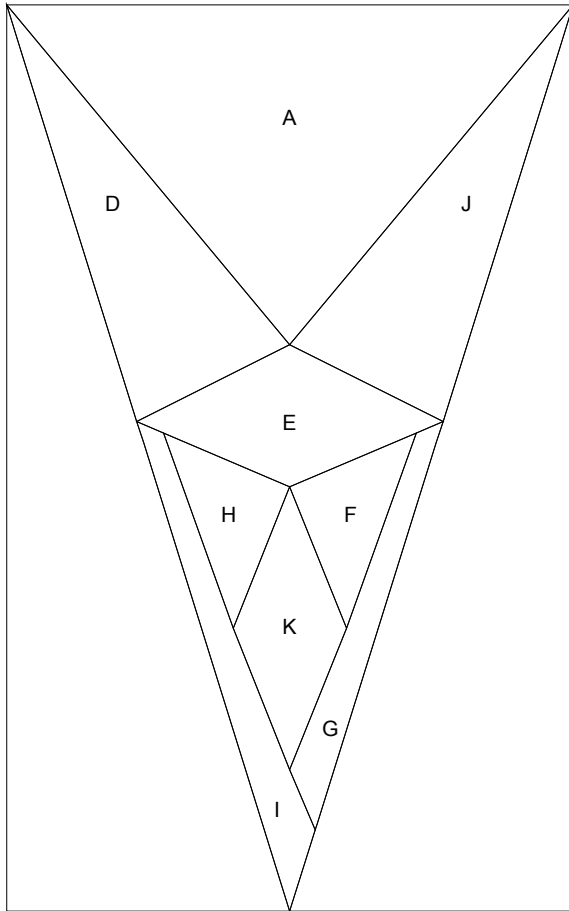

SET PRINTER TO "ACTUAL SIZE" WHEN PRINTING THIS PAGE.

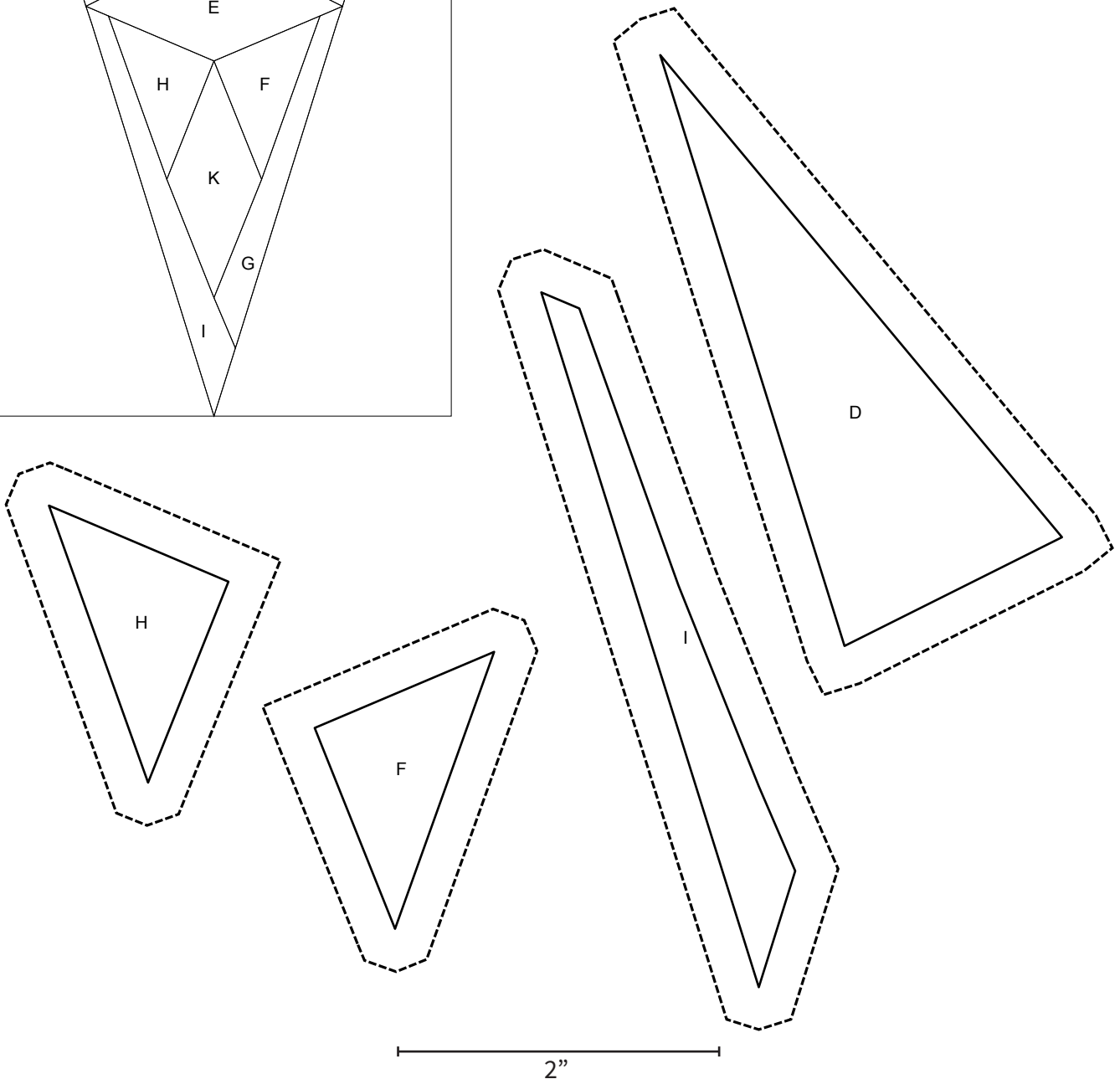

SET PRINTER TO "ACTUAL SIZE" WHEN PRINTING THIS PAGE.

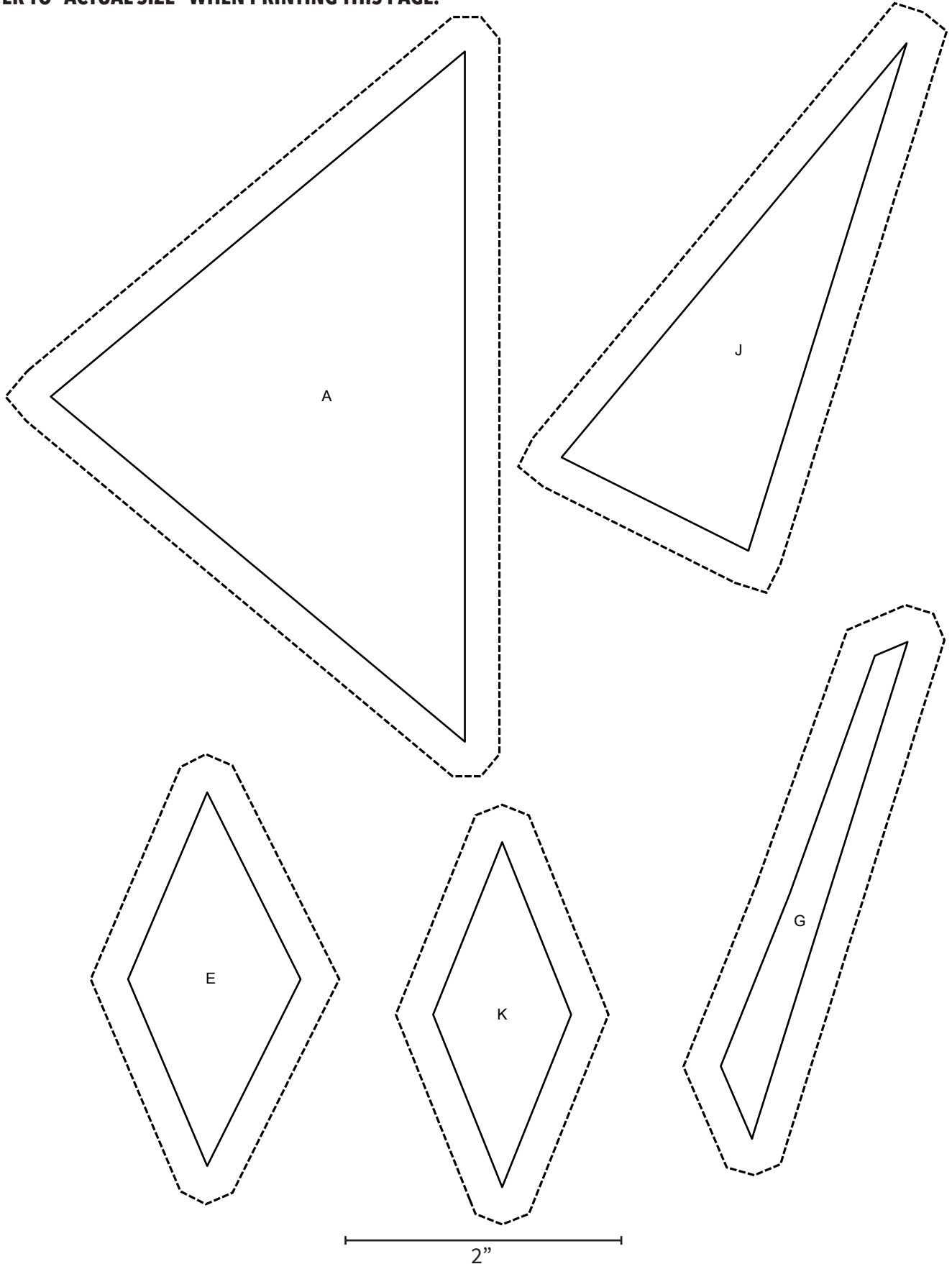



## The Jane Stickle Quilt - Block BT10



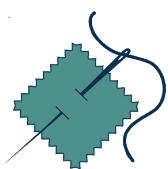

### What you need:

Patches	Quantity/size
B - C	assigned by EQ but not used
A	(1) 1½" x 6"
D - F	(2) 2" x 2½"
E	 (2) 3" x 3" - cut twice diagonally (light blue) (1) 3" x 3" - cut twice diagonally (green)
G	(3) 2" x 2" (green) (6) 2" x 2" (light blue)
H - J - P	(3) 1½" x 3"
I - L - M	(3) 1½" x 1½"
K - Q	(2) 1½" x 2"
N - O	(2) 1" x 1"
R - T	(2) 1½" x 1½"
U - V	(2) 1" x 1"
W - S	(2) 1" x 1"

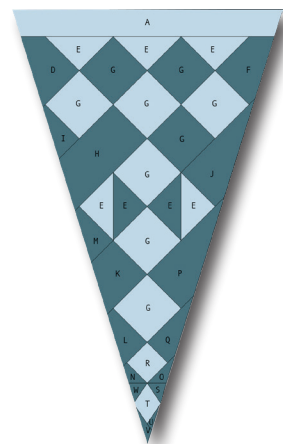

*Hobbystash Colorway*

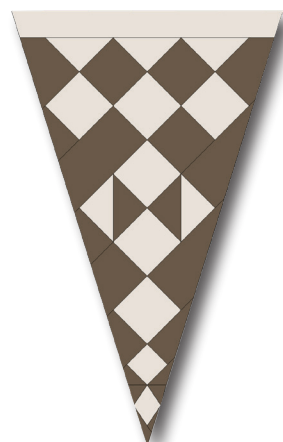

*Jane Stickle Colorway*

### Assembly:

1. Using the templates provided on Pages BT10-2 and BT10-3, foundation piece each section.
2. Join the sections together.

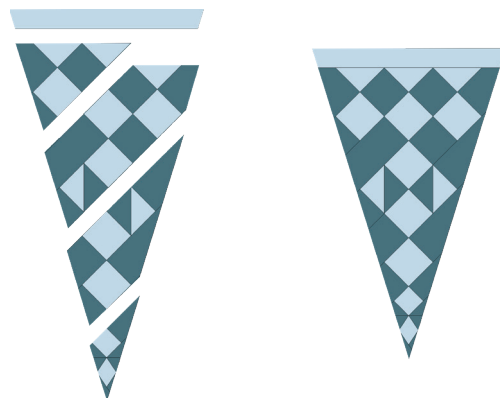

SET PRINTER TO "ACTUAL SIZE" WHEN PRINTING THIS PAGE.

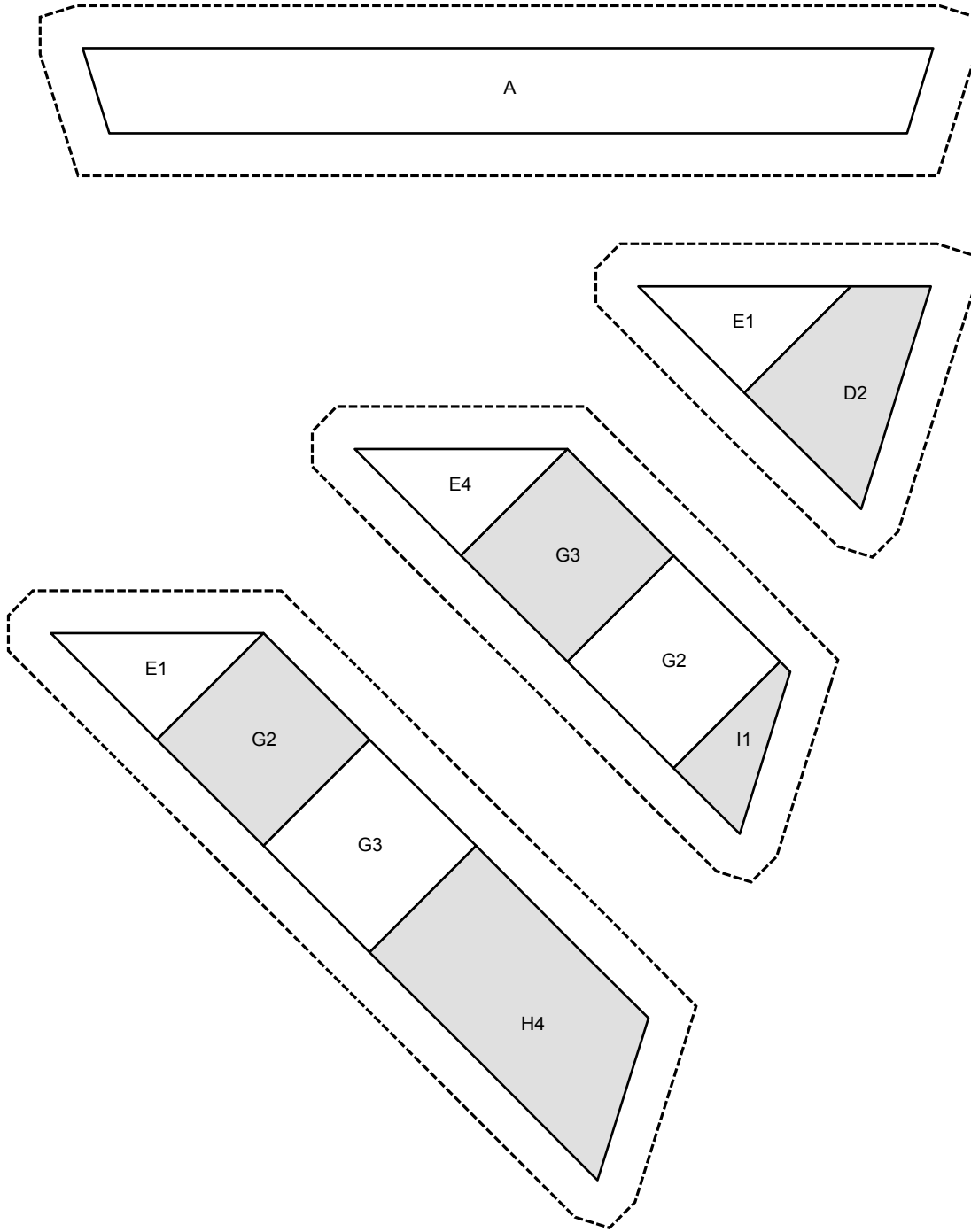

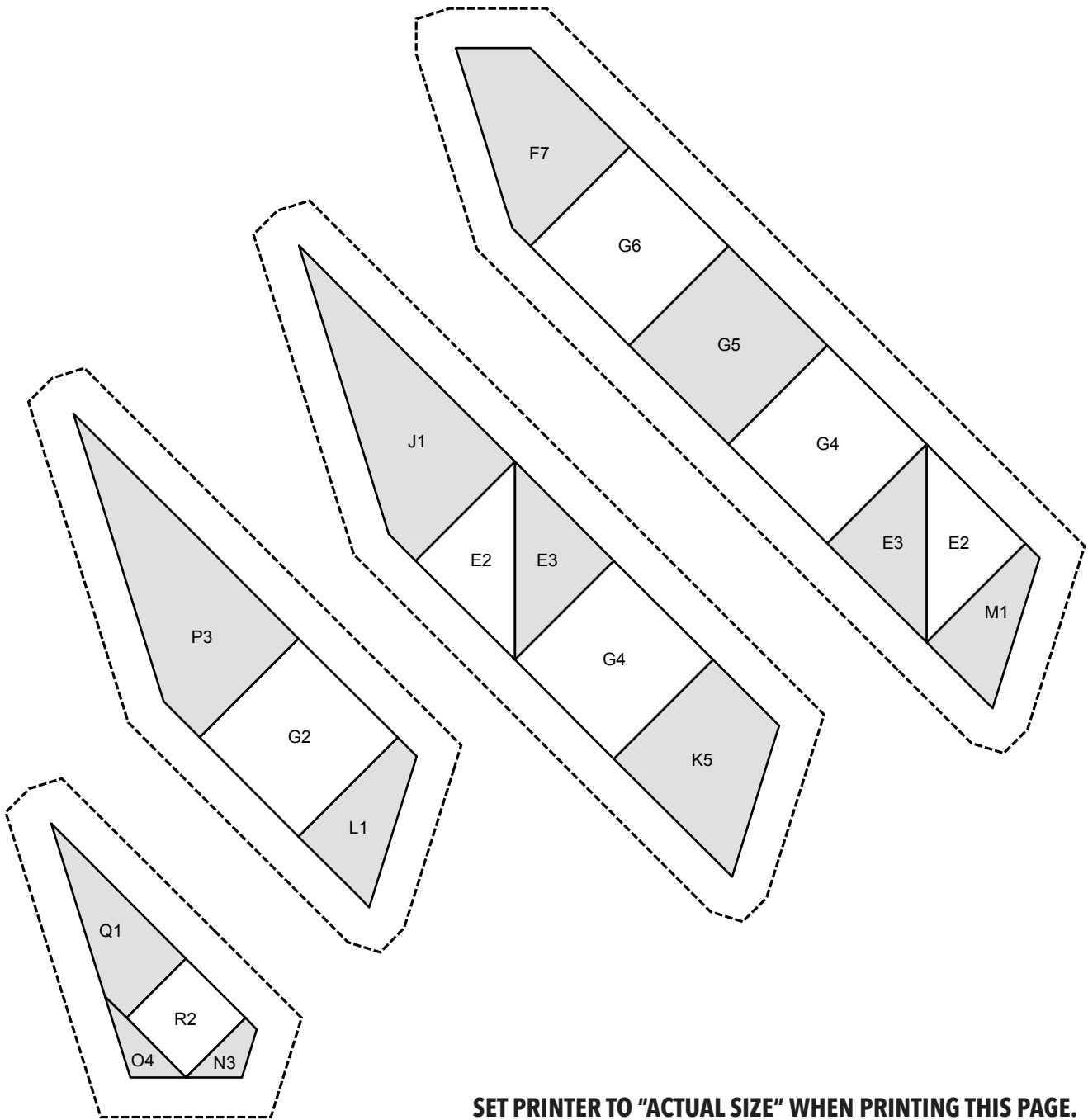

**SET PRINTER TO "ACTUAL SIZE" WHEN PRINTING THIS PAGE.**

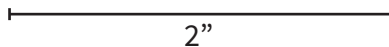
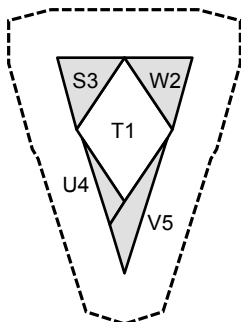

SET PRINTER TO "ACTUAL SIZE" WHEN PRINTING THIS PAGE.

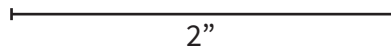
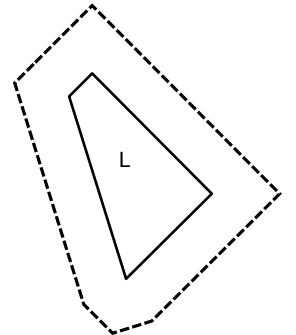
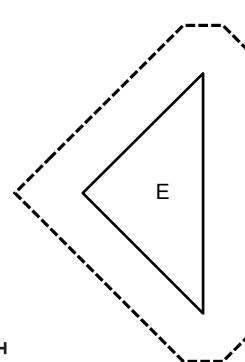
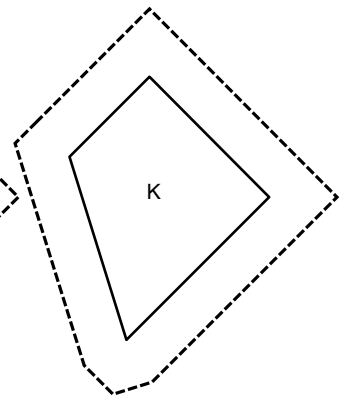
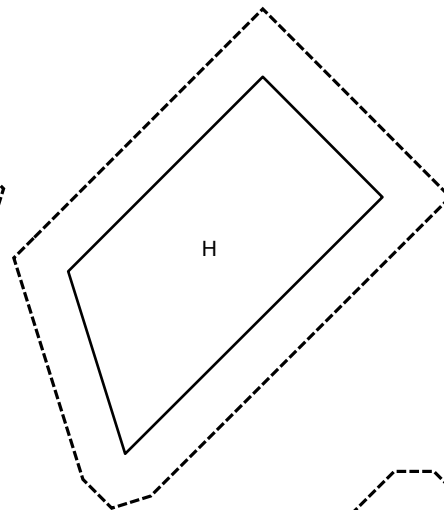
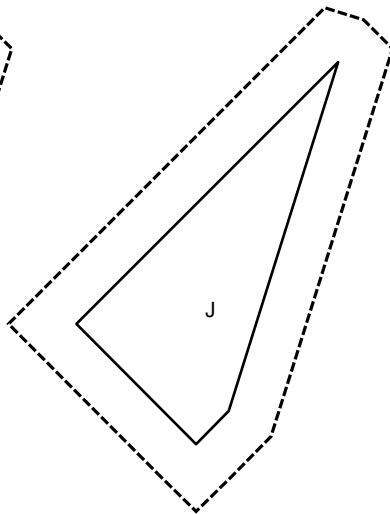
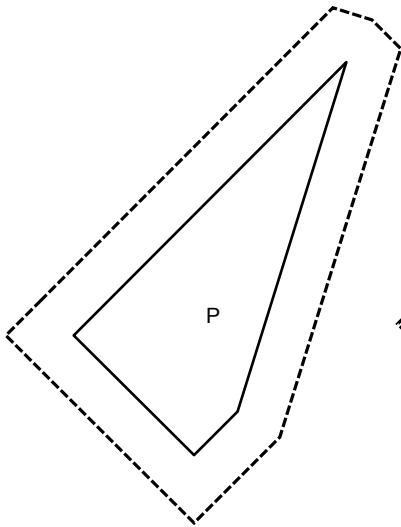
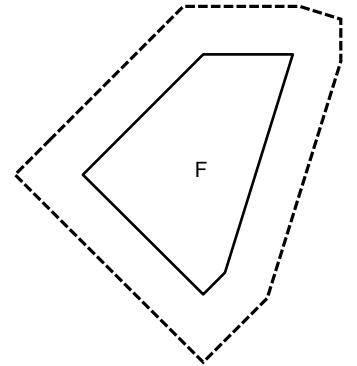
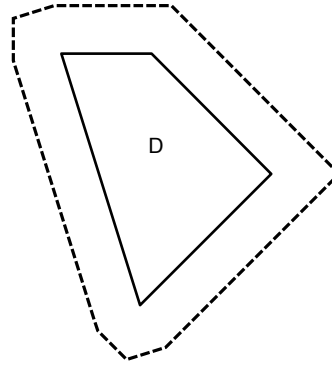
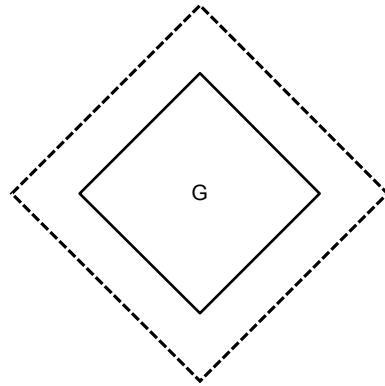
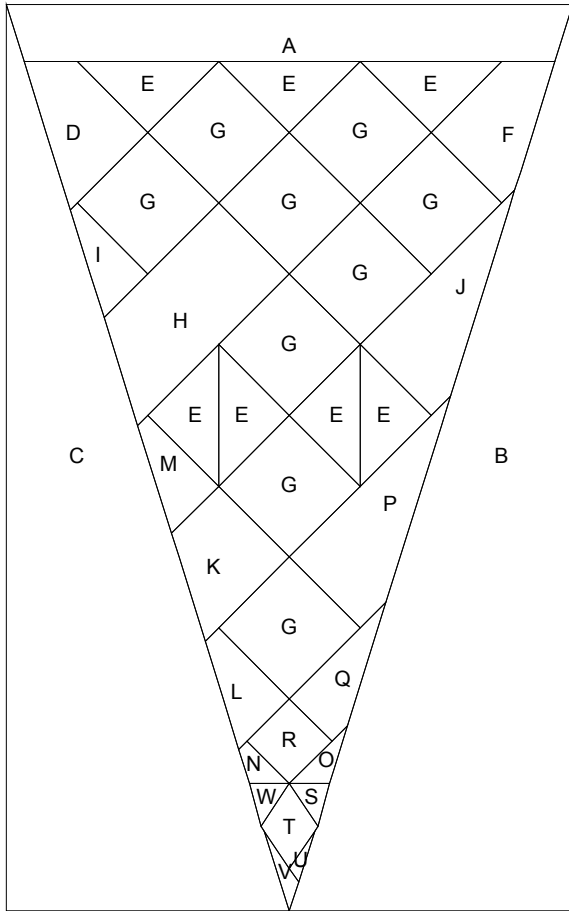

SET PRINTER TO "ACTUAL SIZE" WHEN PRINTING THIS PAGE.

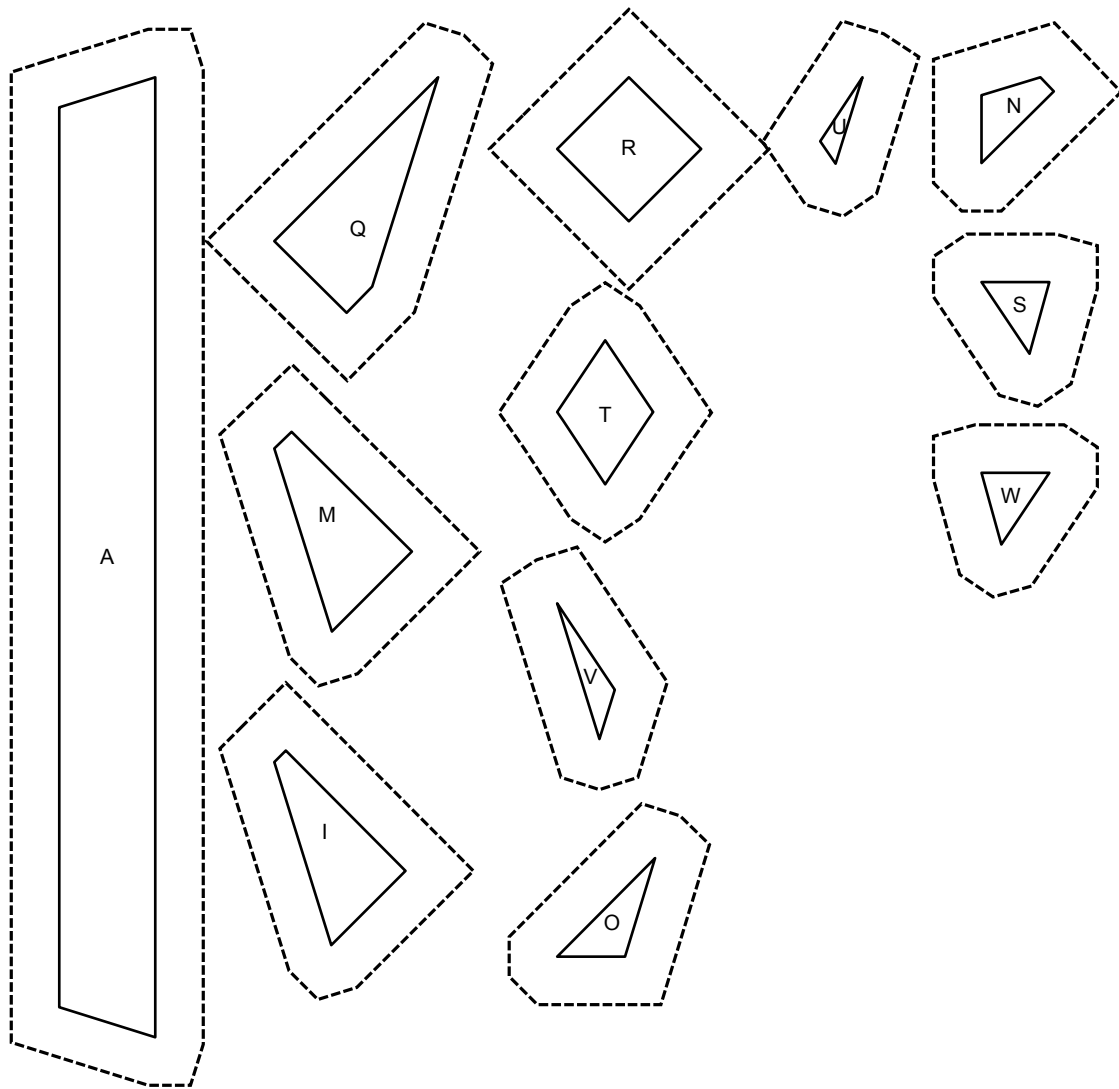

2"

## The Jane Stickle Quilt - Block BT11



### What you need:

Patches	Quantity/size
B - C	assigned by EQ but not used
A	(1) 3" x 7"
D - G	(2) 1½" x 3"
E - F	(2) 2½" x 2½"
H - N	(2) 1½" x 3½"
I - P	(2) 1½" x 1½" (light blue) (2) 1½" x 1½" (navy)
J - O	(2) 1½" x 2"
K - L	(2) 1½" x 3"
M	(3) 1½" x 2½" (light blue) (2) 1½" x 2½" (navy)
Q - T	(2) 1½" x 3½"
R - S	(2) 1" x 1½"
U - V	(2) 2" x 5"

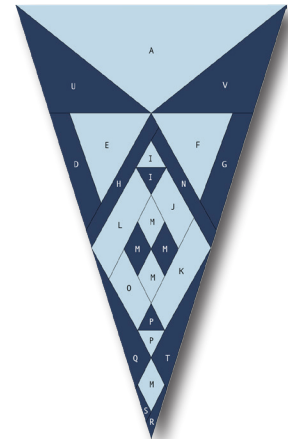

*Hobbystash Colorway*

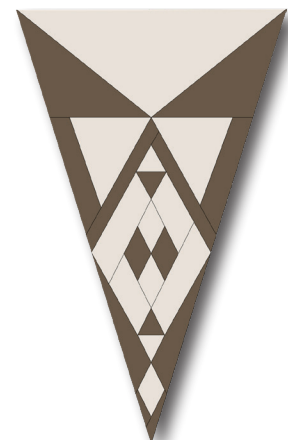

*Jane Stickle Colorway*

### Assembly:

- Using the templates provided on Page BT11-3 and BT11-4, foundation piece each section.
- Join the sections together.

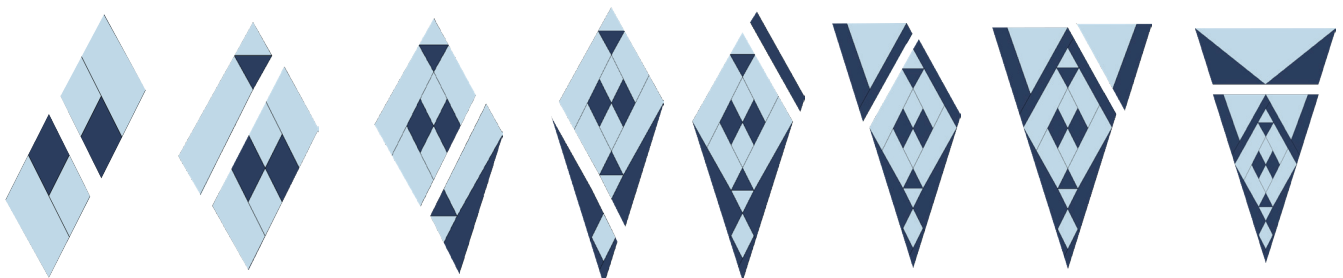



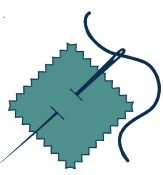

SET PRINTER TO "ACTUAL SIZE" WHEN PRINTING THIS PAGE.

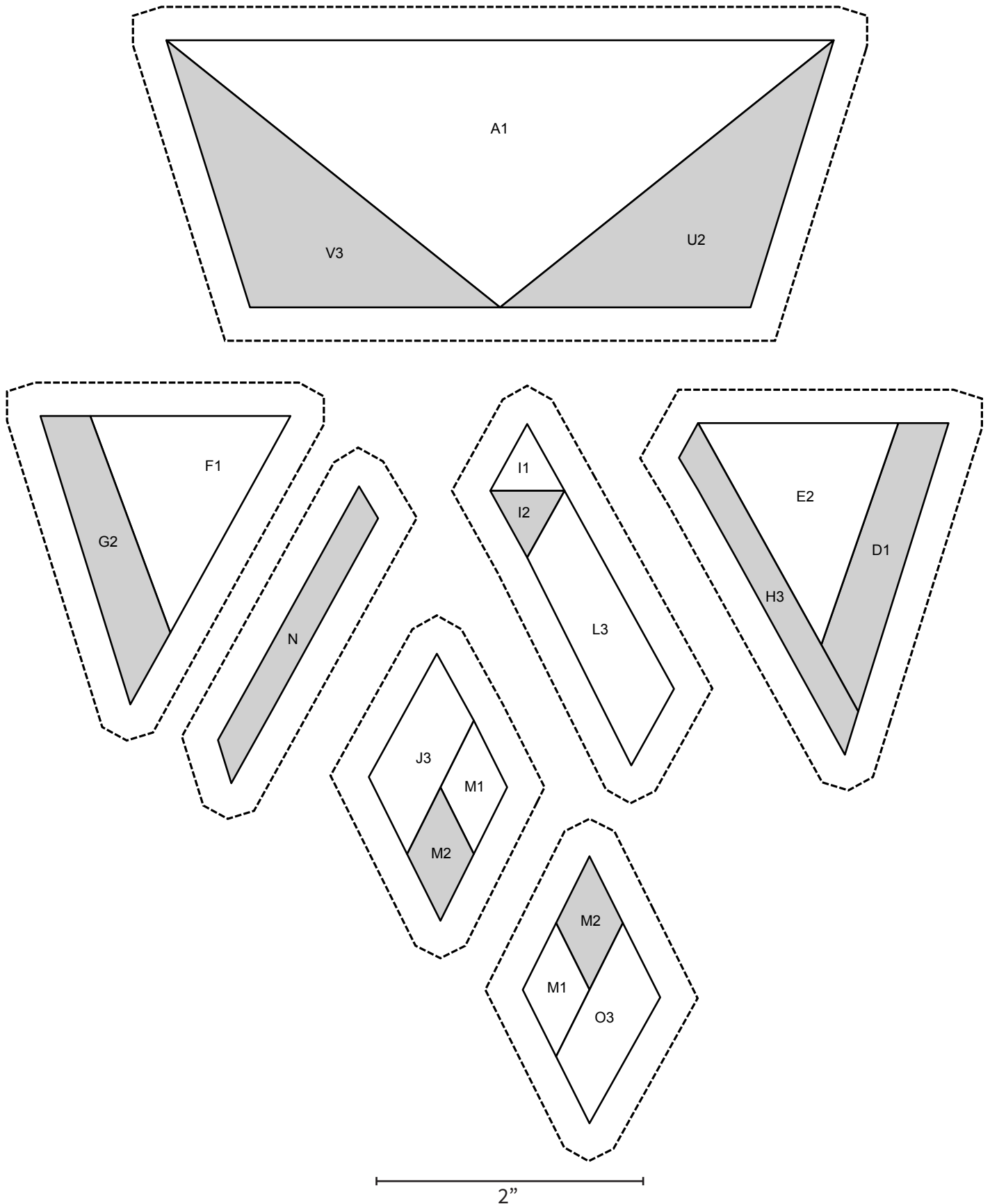

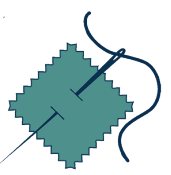

SET PRINTER TO "ACTUAL SIZE" WHEN PRINTING THIS PAGE.

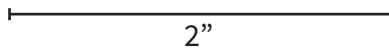
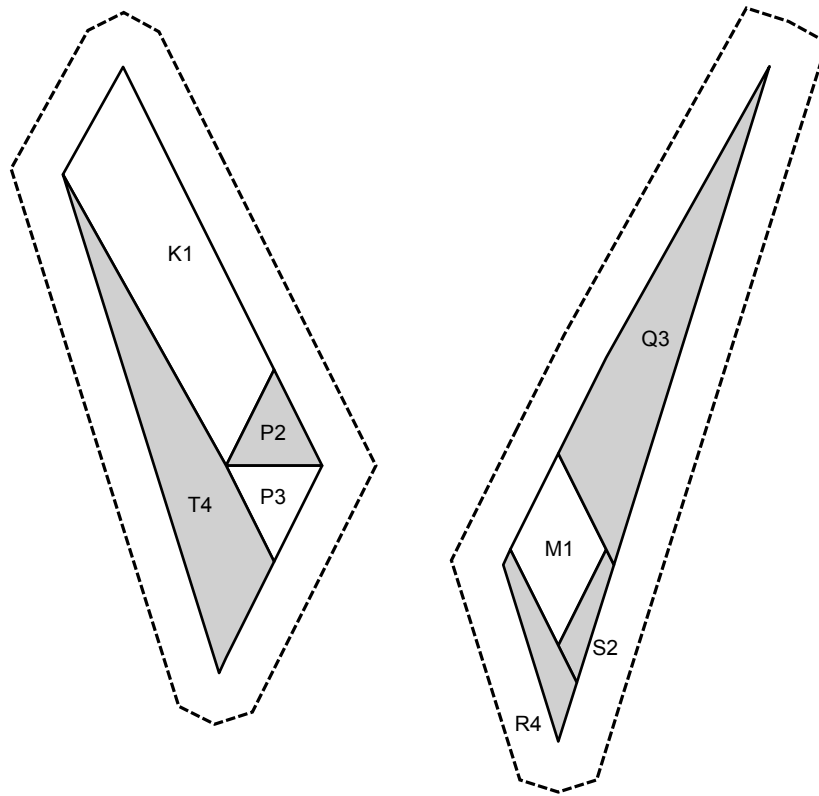

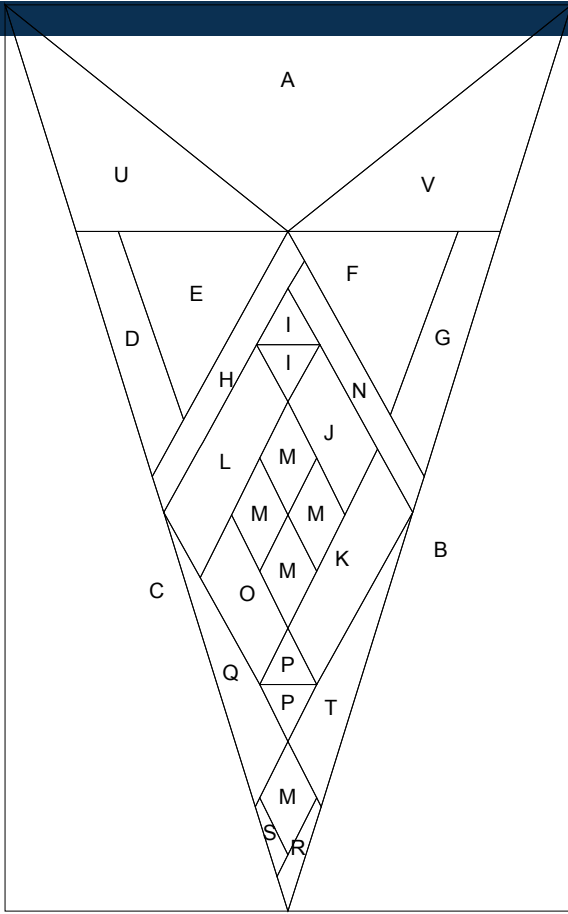

SET PRINTER TO "ACTUAL SIZE" WHEN PRINTING THIS PAGE.

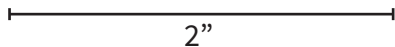
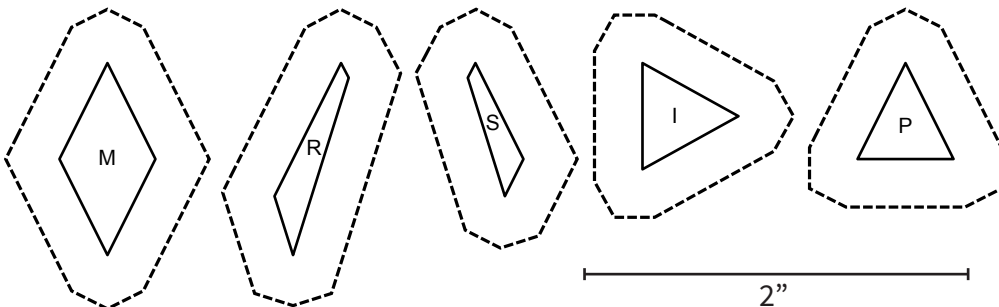
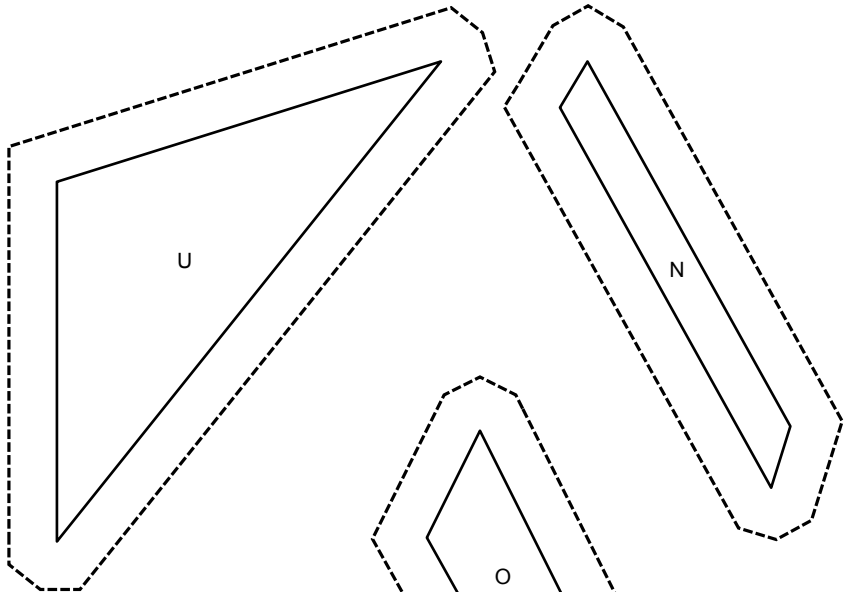
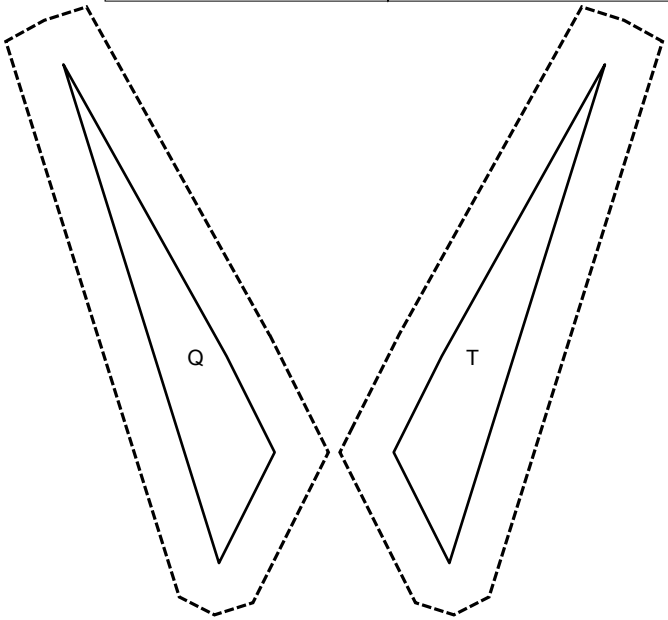
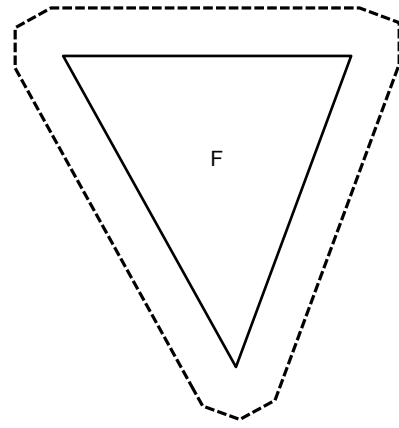

SET PRINTER TO "ACTUAL SIZE" WHEN PRINTING THIS PAGE.

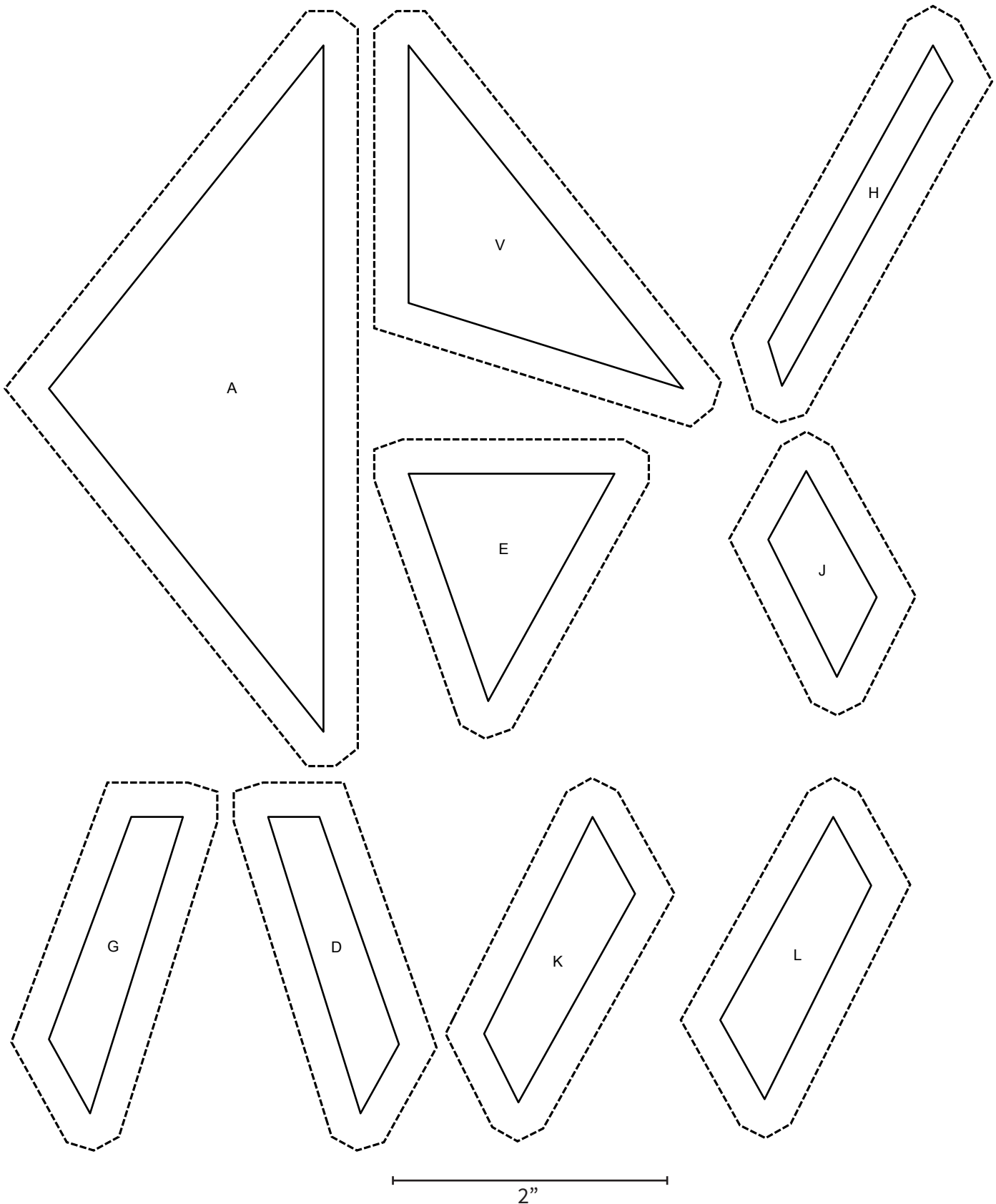

## The Jane Stickle Quilt - Block BT12



### What you need:

Patches	Quantity/size
B - C	assigned by EQ but not used
A	(1) 2½" x 6"
D	(1) 1½" x 9"
E	(1) 1½" x 9"
F	(1) 4½" x 6½"
G	(1) 1½" x 1½"
H	(1) 3" x 5"

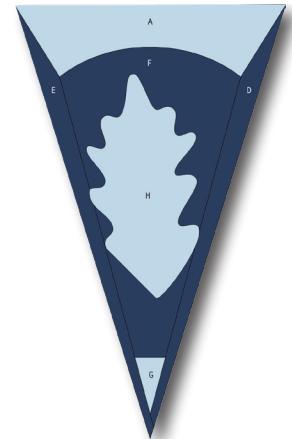

*Hobbystash Colorway*



*Jane Stickle Colorway*

### Assembly:

- Using the templates provided on Page BT12-3, foundation piece each section.
- Join the sections together. Applique leaf to top of triangle as shown.



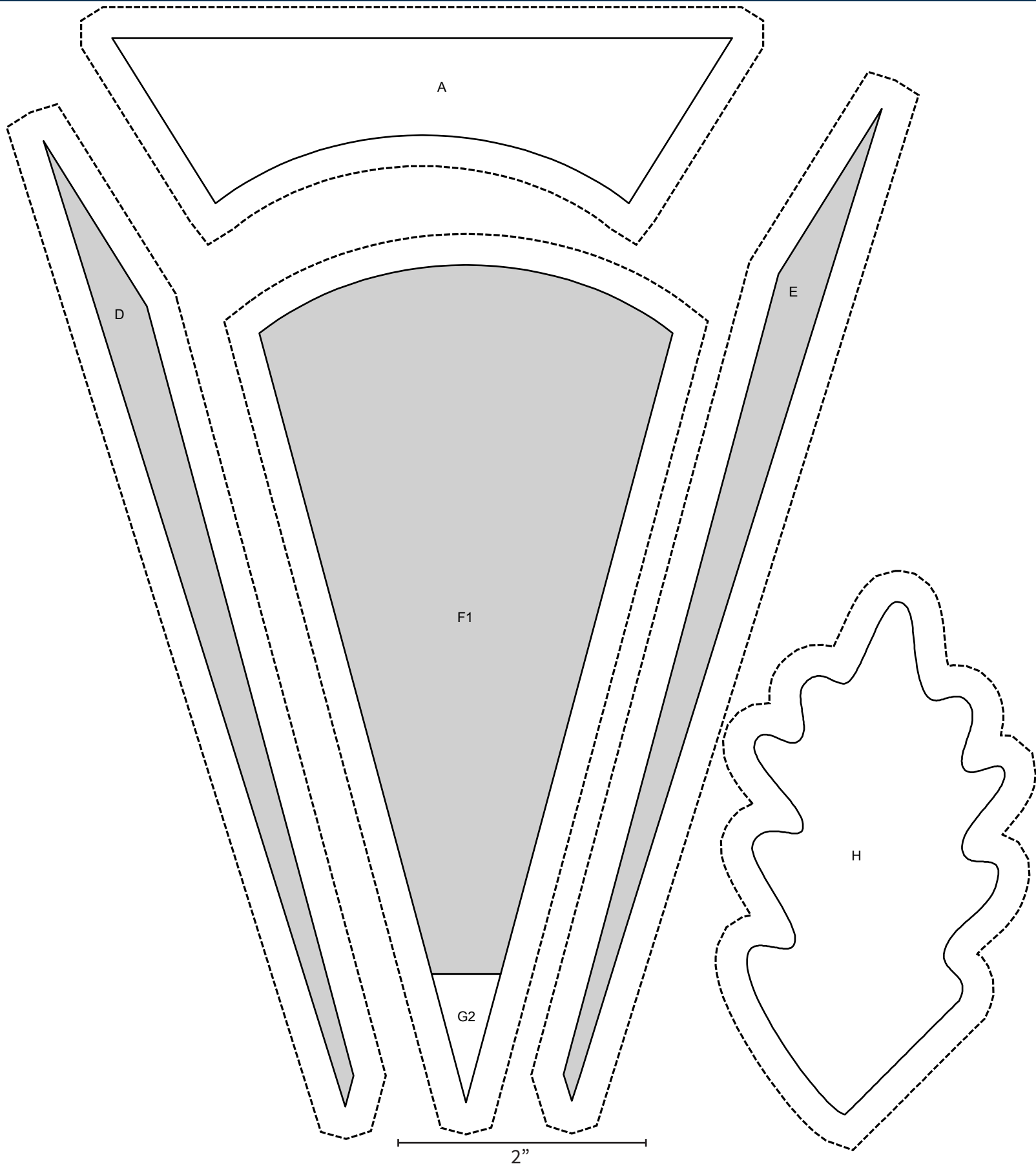

SET PRINTER TO "ACTUAL SIZE" WHEN PRINTING THIS PAGE.

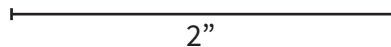
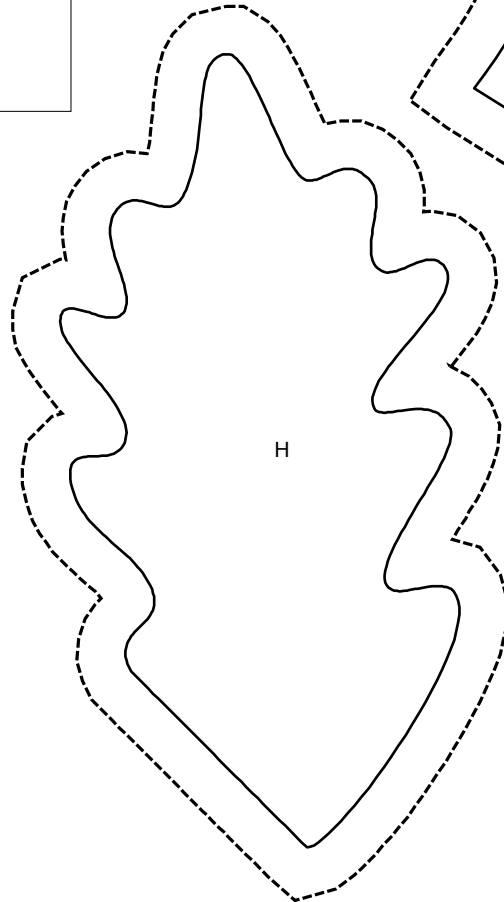
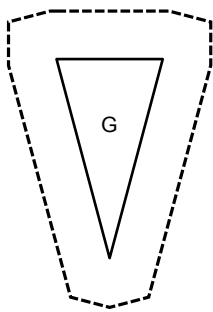
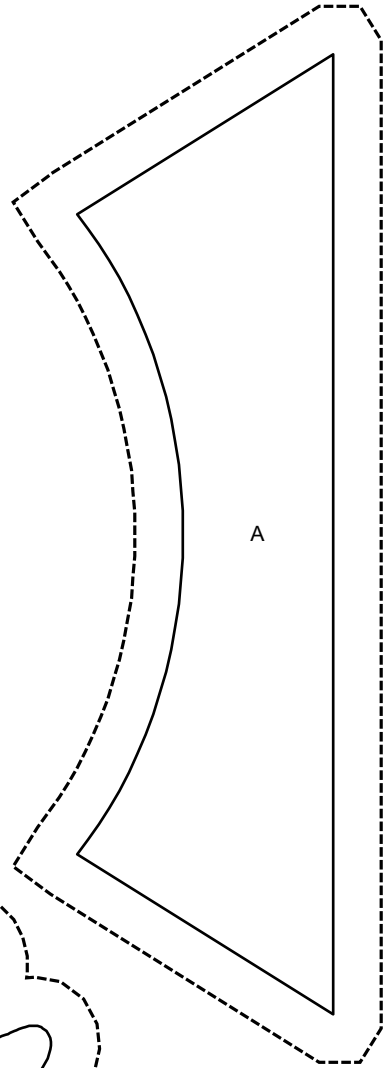
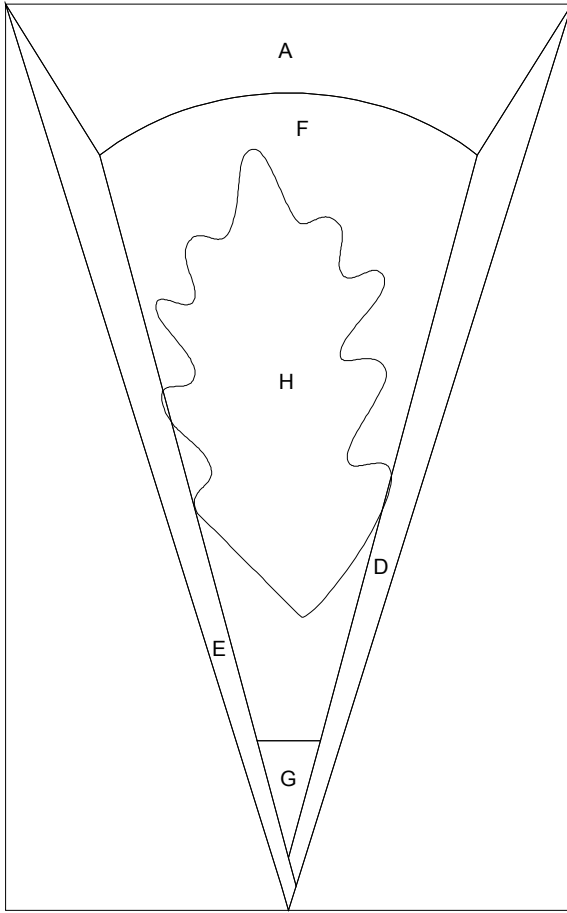



SET PRINTER TO "ACTUAL SIZE" WHEN PRINTING THIS PAGE.

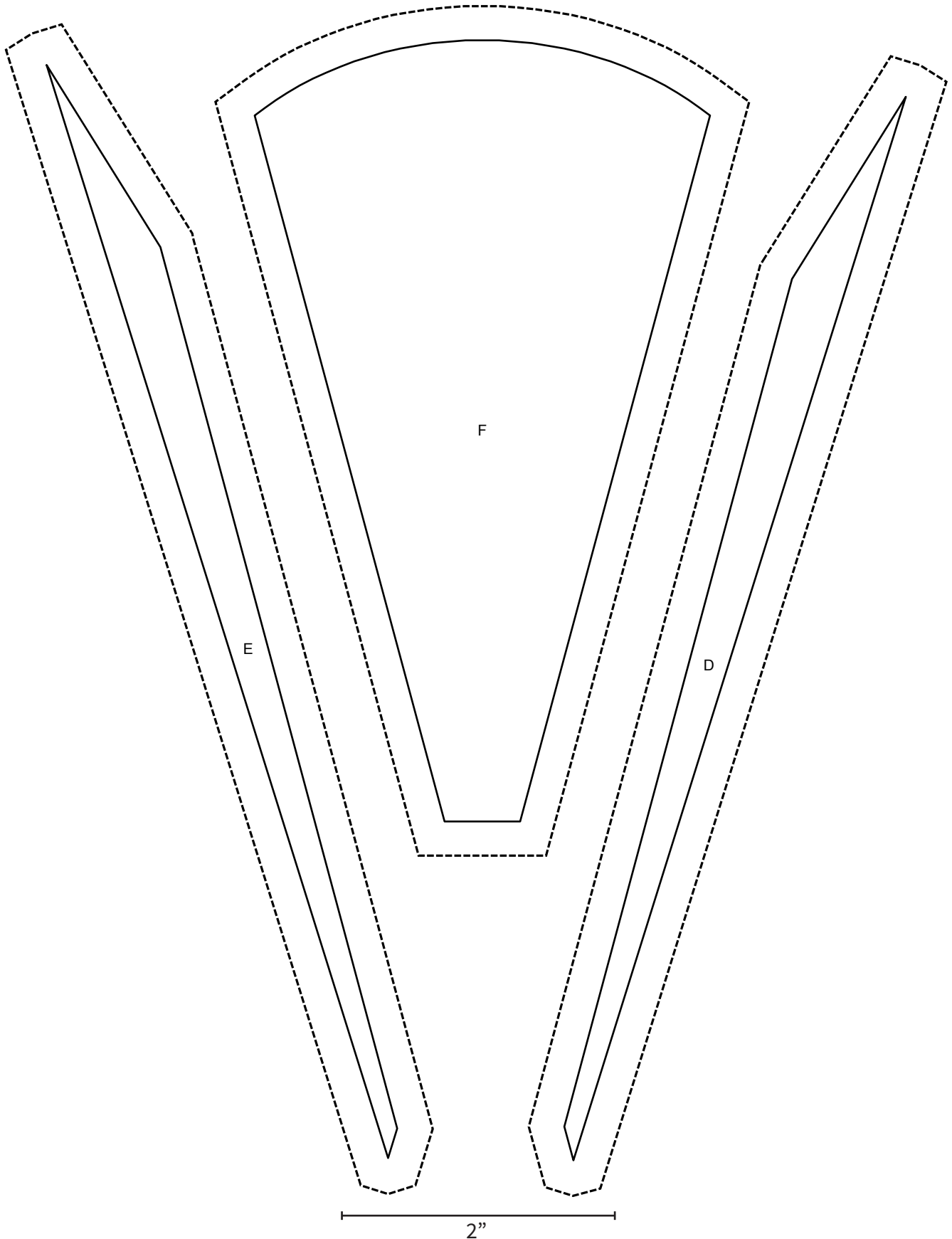

## The Jane Stickle Quilt - Block BT13



### What you need:

Patches	Quantity/size
B - C	assigned by EQ but not used
A	(1) 3" x 6½"
D	(1) 1½" x 3"
E	(1) 1½" x 2"
F	(1) 1½" x 2"
G - I - Q	(3) 1½" x 2"
H	(1) 2" x 3"
J - L	(2) 2" x 2½"
K	(1) 2½" x 3½"
M	(1) 2" x 3½"
N - O	(2) 2" x 5"
P	(1) 2" x 2"
R	(1) 2" x 3½"
S	(1) 1½" x 3"
T - U	(2) 2" x 2½"

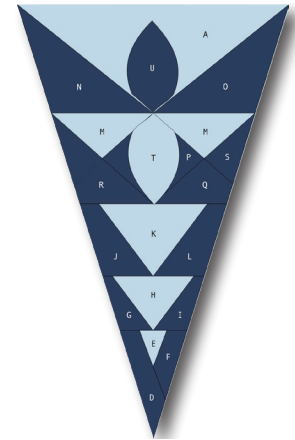

Hobbystash Colorway

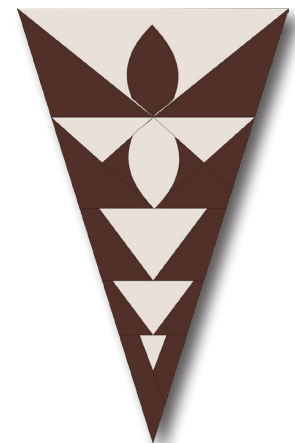

Jane Stickle Colorway

### Assembly:

- Using the templates provided on Page BT13-3 and BT13-4, foundation piece each section.
- Join the sections together. Applique drops to top of block.

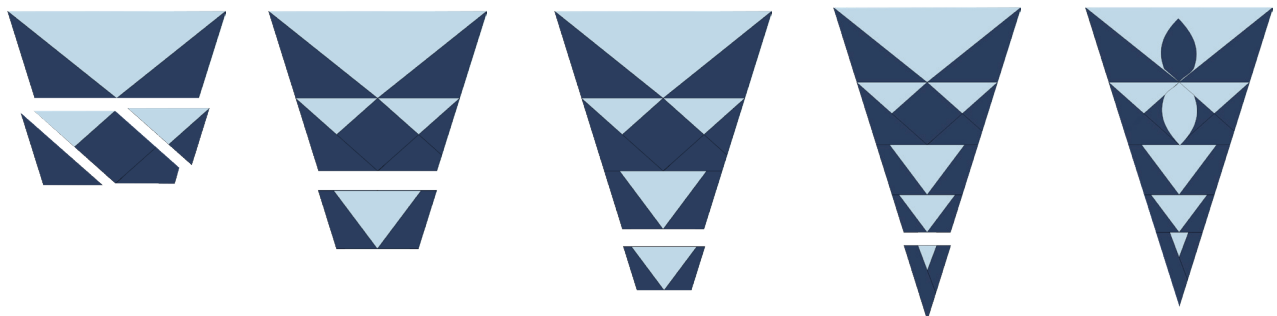

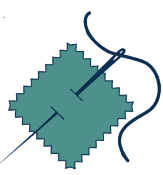

SET PRINTER TO "ACTUAL SIZE" WHEN PRINTING THIS PAGE.

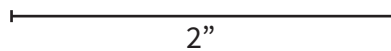
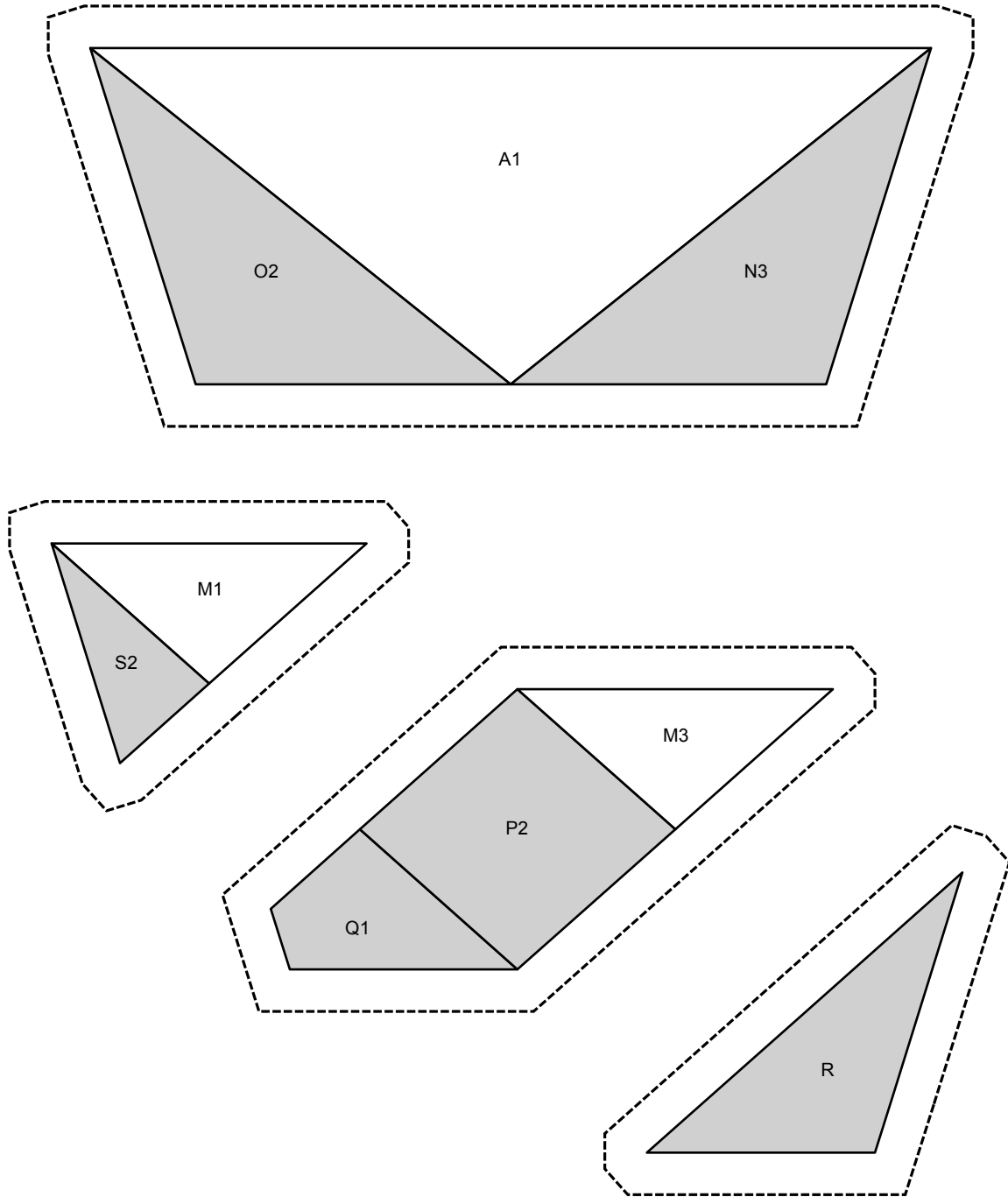

SET PRINTER TO "ACTUAL SIZE" WHEN PRINTING THIS PAGE.

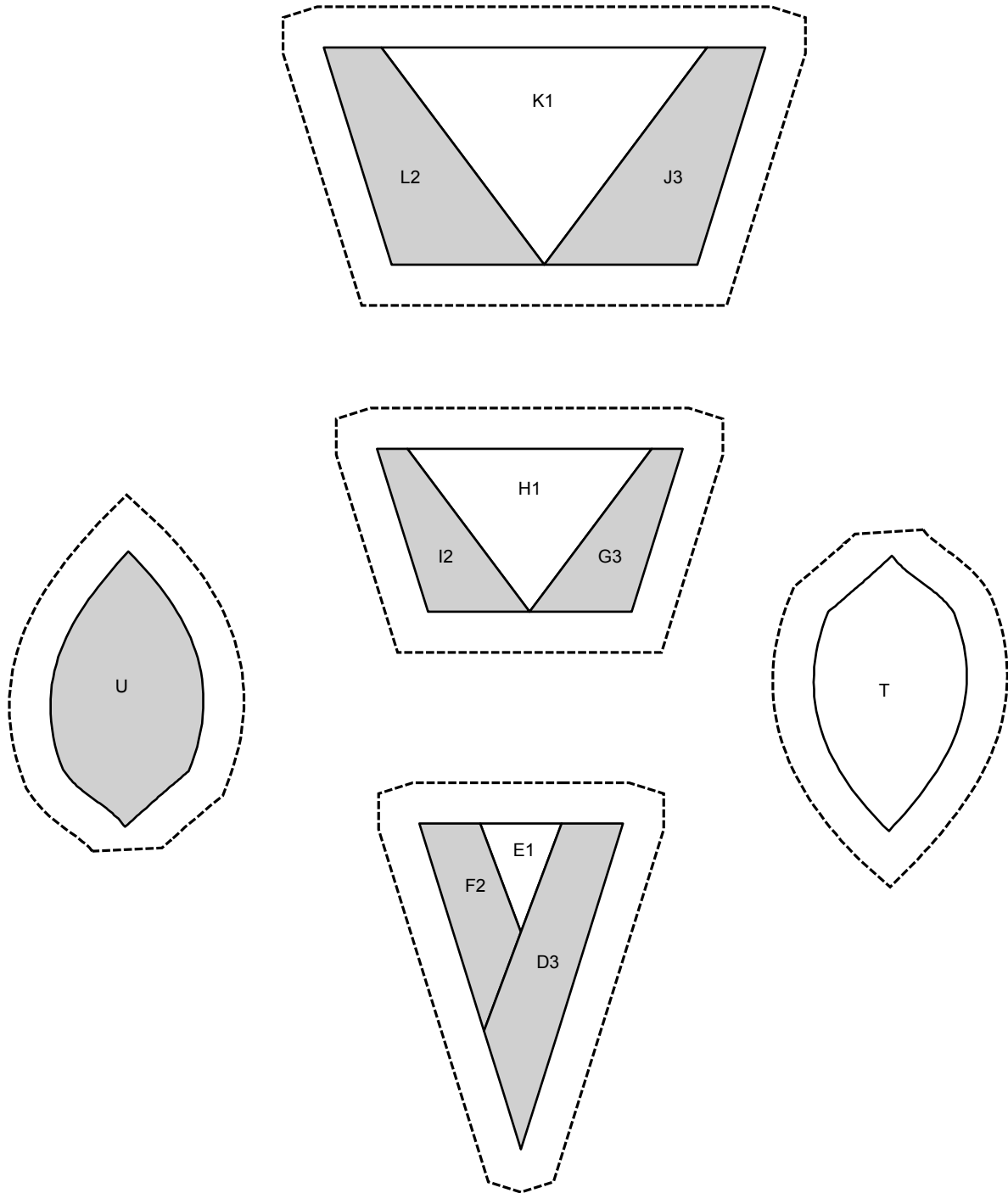

SET PRINTER TO "ACTUAL SIZE" WHEN PRINTING THIS PAGE.

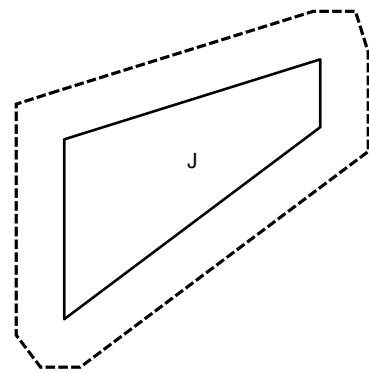
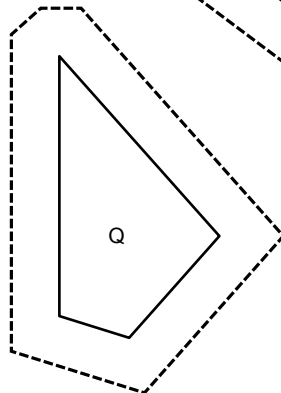
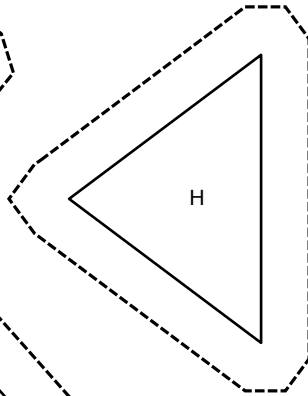
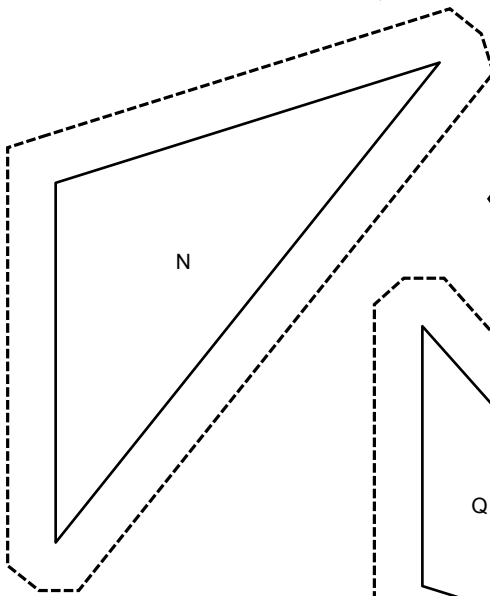
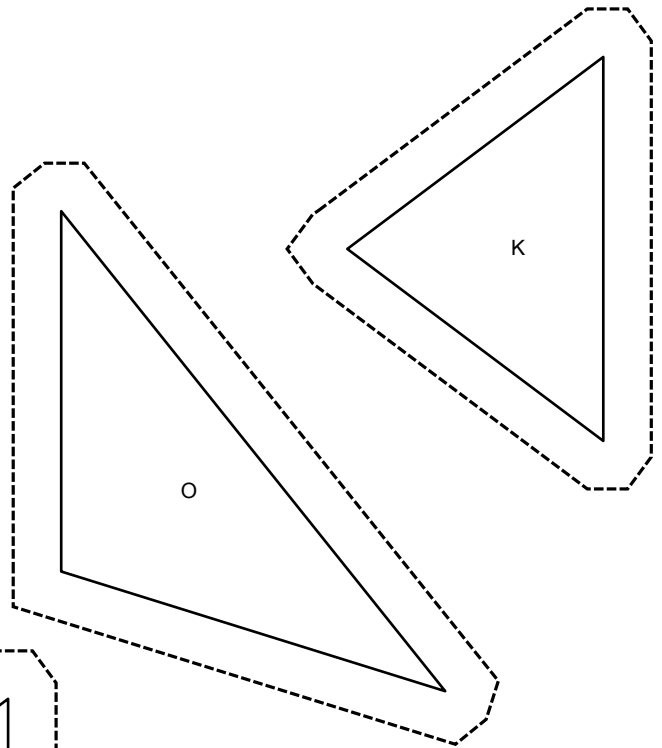
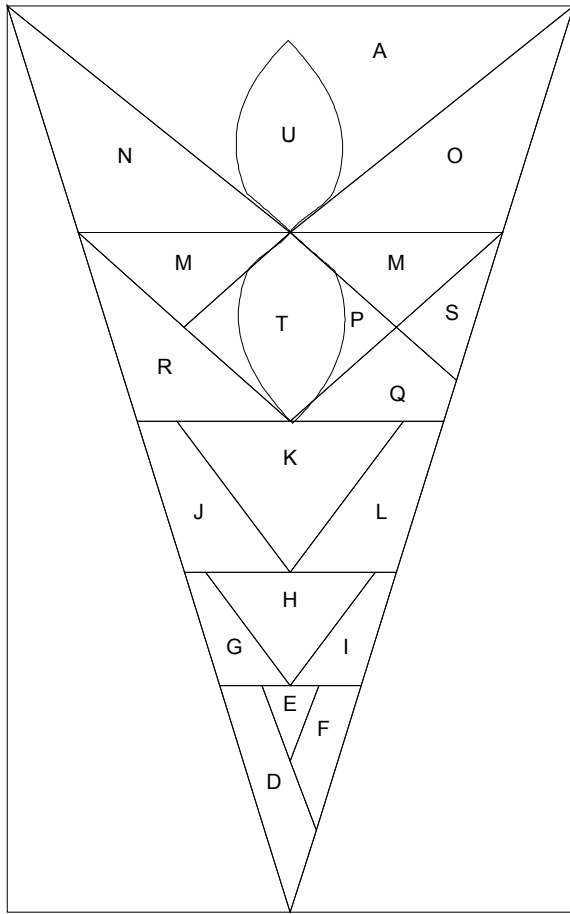

2"

