

# The Jane Stickle Quilt - Row L

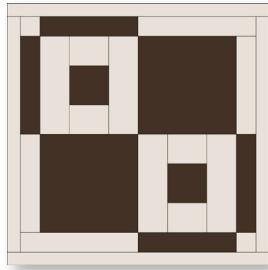

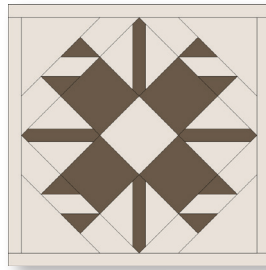

L1



L2

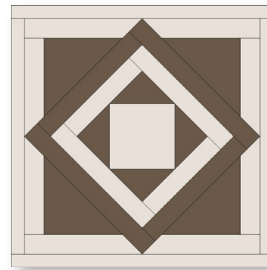

L3

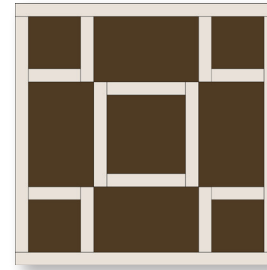

L4

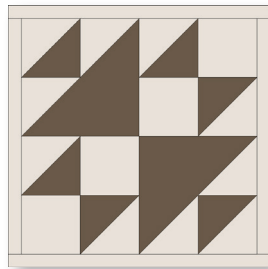

L5

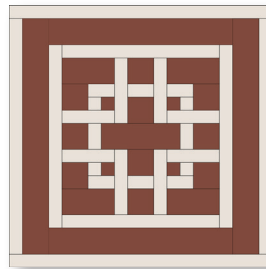

L6

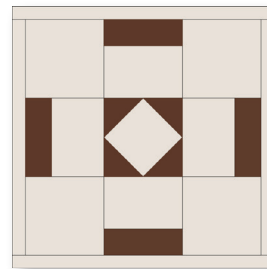

L7

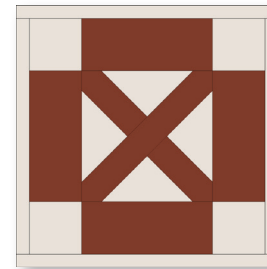

L8

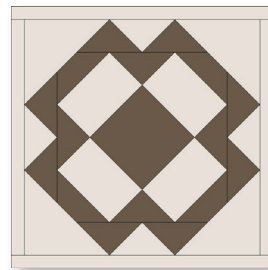

L9

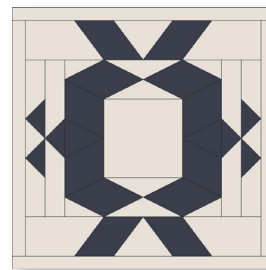

L10

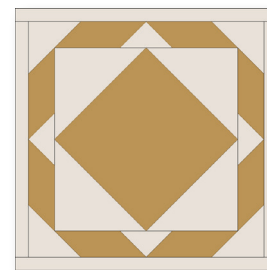

L11

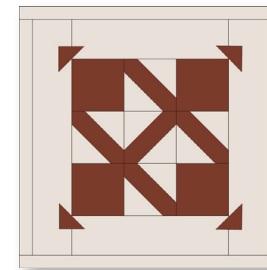

L12

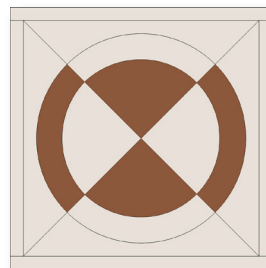

L13



## The Jane Stickle Quilt - Block L1

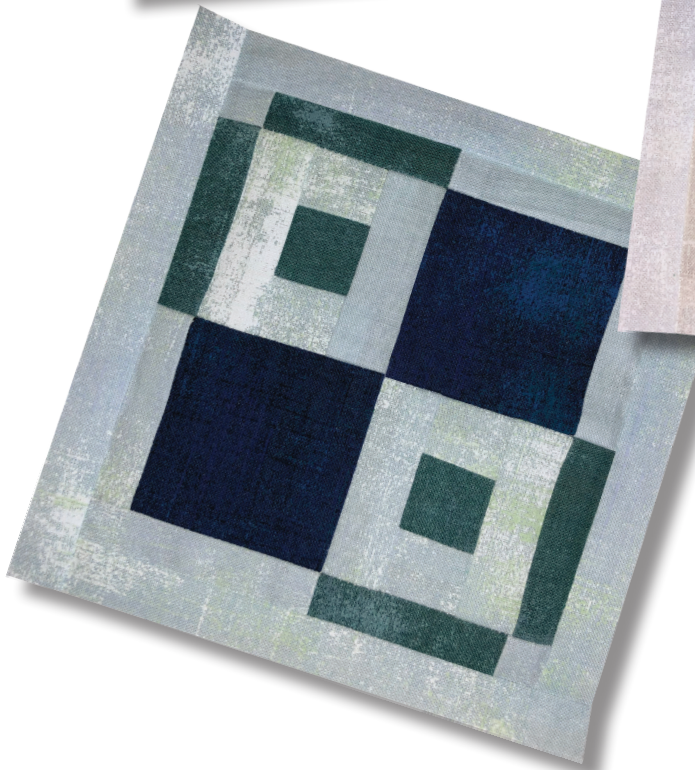

### What you need:

Patches	Quantity/size
A*	(2) 1" x 6"
B*	(2) 1" x 5"
C	(2) 1½" x 1½"
D	(4) 1½" x 3" - green (2) 1½" x 3" - light blue
E	(2) 1½" x 3"
F	(4) 1½" x 3"
G	(2) 3" x 3"
H	(4) 1½" x 1½"
I	(2) 1½" x 1½"

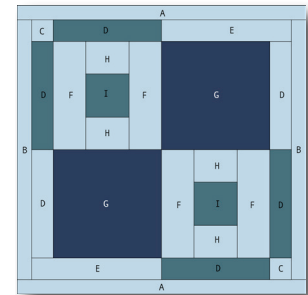

*Hobby Stash Colorway*

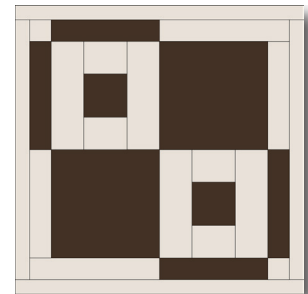

*Jane Stickle Colorway*

*\*The actual required width for Unit A and Unit B units is ¾". The increased width specified above allows for squaring the block to exactly 5½".*

### Assembly:

1. Using templates on Page L1-2, foundation piece sections. Arrange and sew together.
2. Join Unit B to the right side of the block, and then the left.
3. Join Unit A to the top of the block and then the bottom. Square up block to measure 5½" x 5½" square.

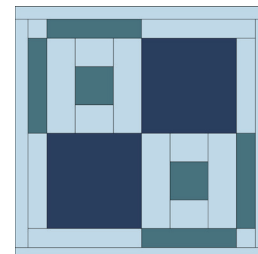
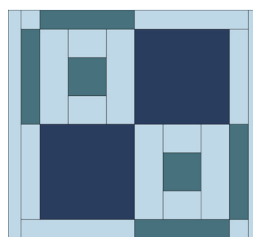
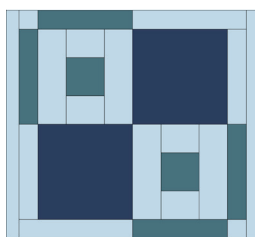

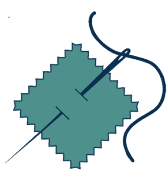

SET PRINTER TO "ACTUAL SIZE" WHEN PRINTING THIS PAGE.

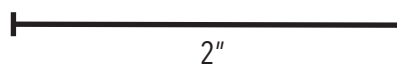
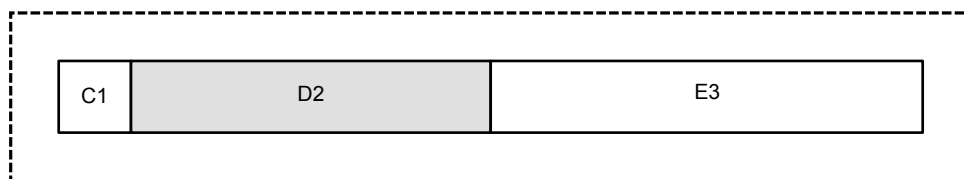
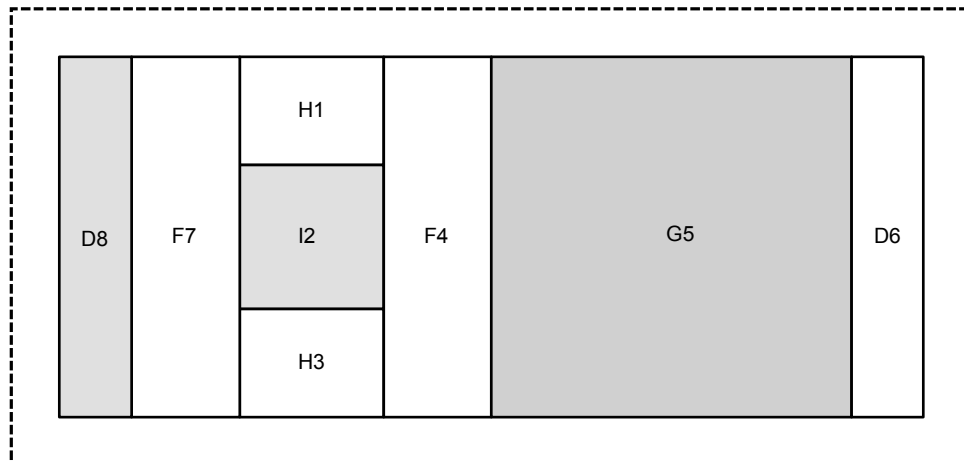
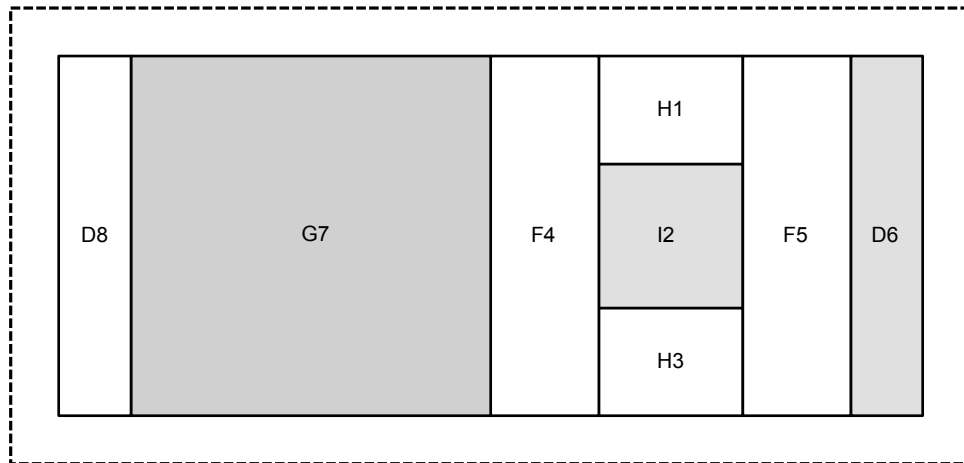
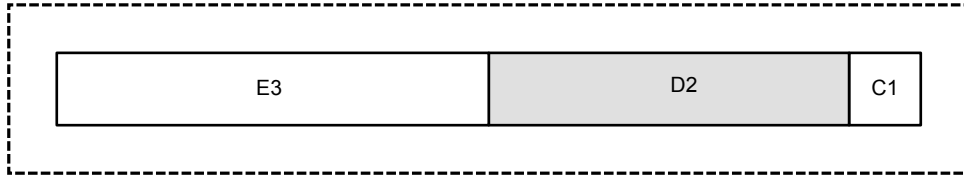

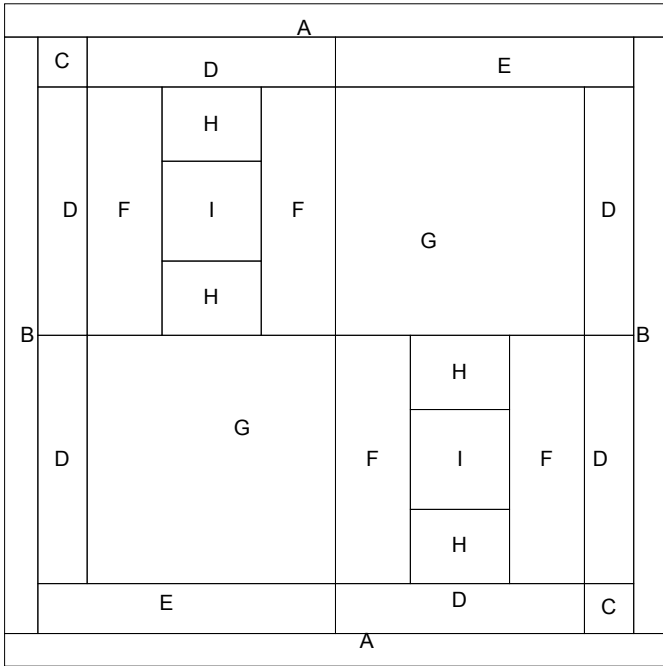

SET PRINTER TO "ACTUAL SIZE" WHEN PRINTING THIS PAGE.

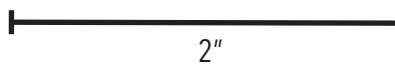
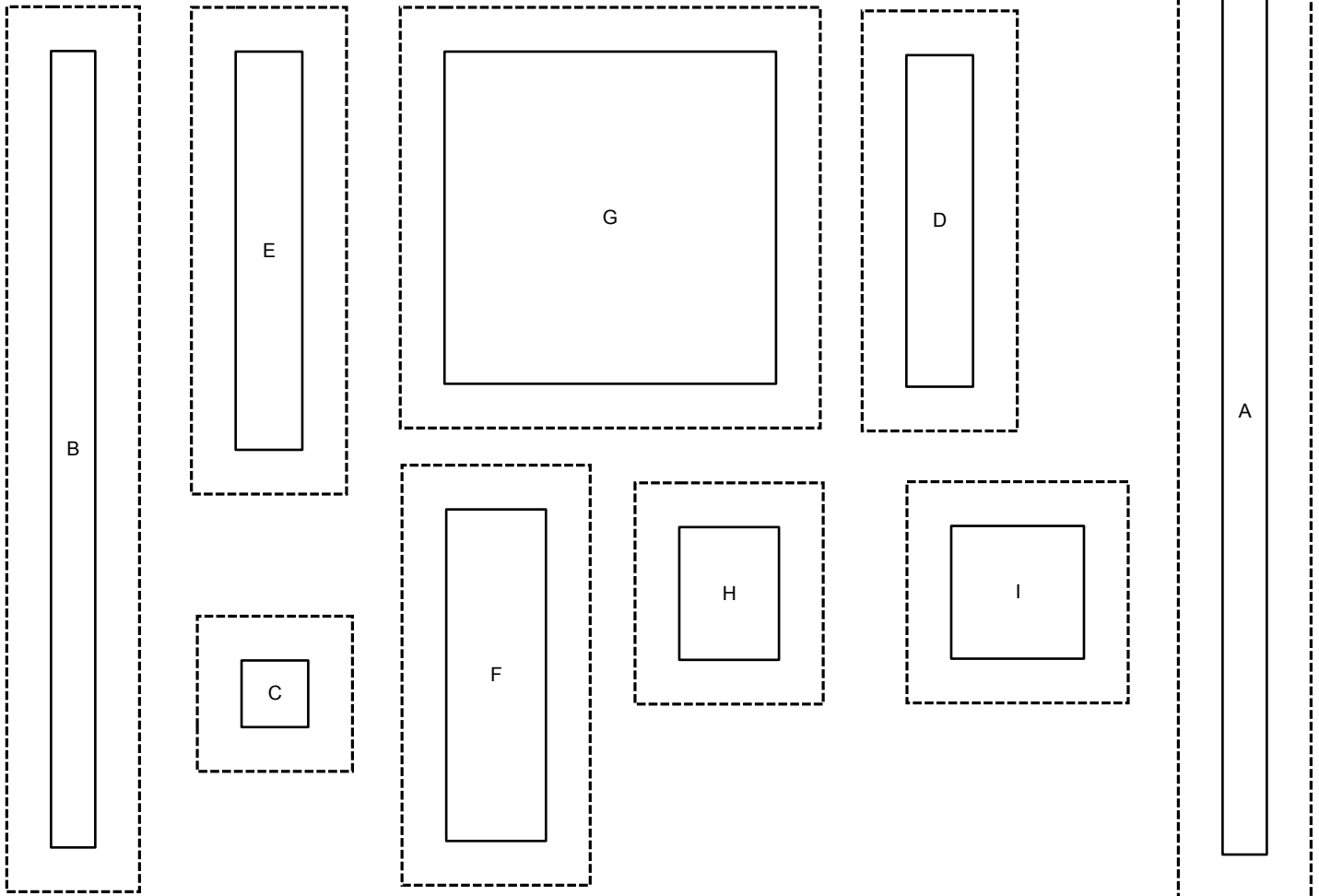



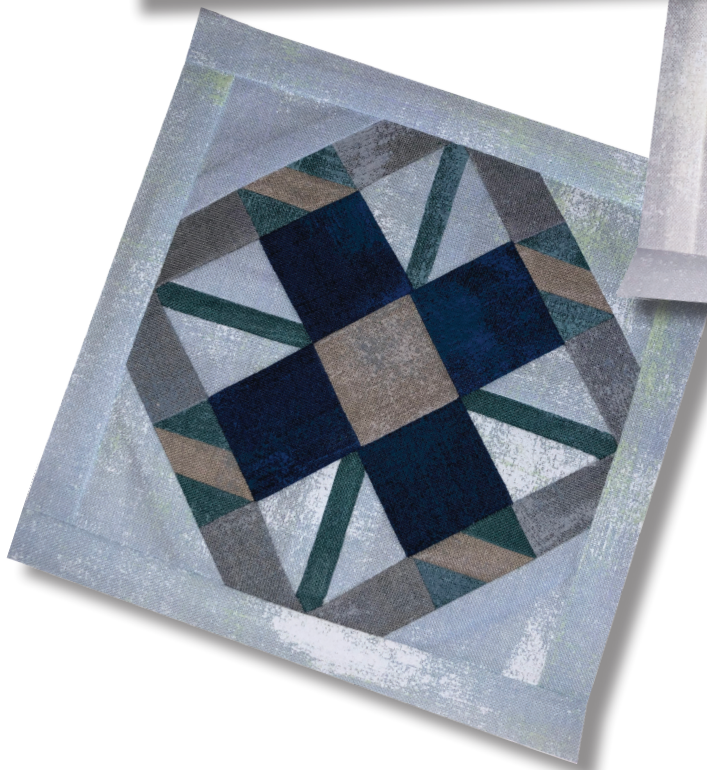
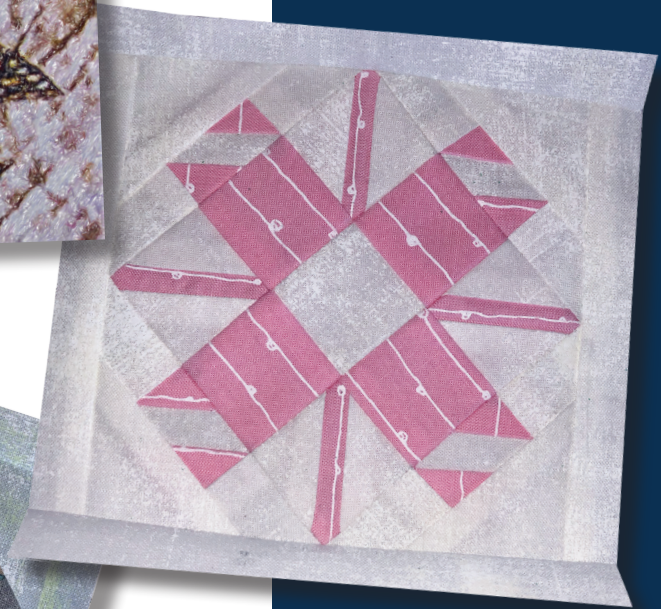
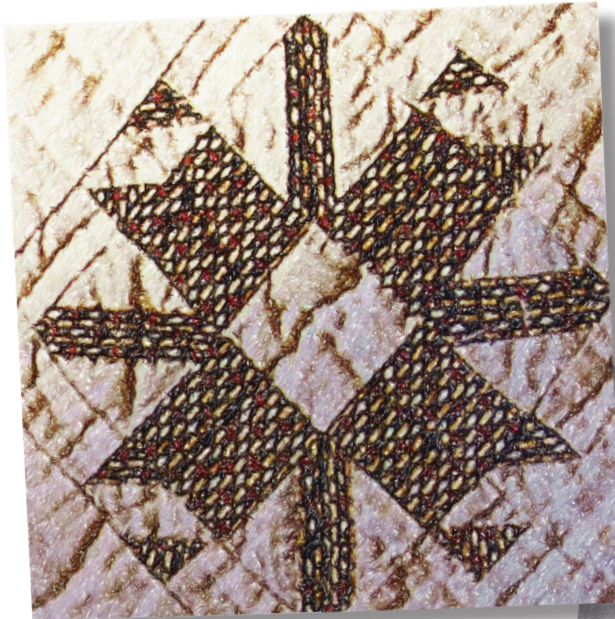

## The Jane Stickle Quilt - Block L2



### What you need:

Patches	Quantity/size
A*	(2) 1" x 6"
B*	(2) 1" x 5"
C 	(2) 3" x 3" - cut once diagonally
D	(4) 1½" x 2½"
E	(4) 1½" x 2½"
F	(4) 1" x 3"
G 	(2) 3" x 3" - cut twice diagonally
H	(4) 2" x 2" - navy (1) 2" x 2" - beige
I 	(2) 2½" x 2½" - cut twice diagonally
J	(2) - 1½" x 2"
K	(2) - 1½" x 2"

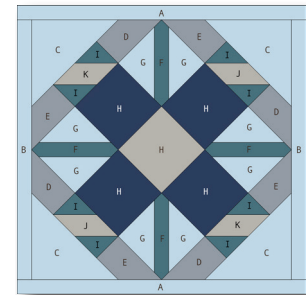

*Hobby Stash Colorway*

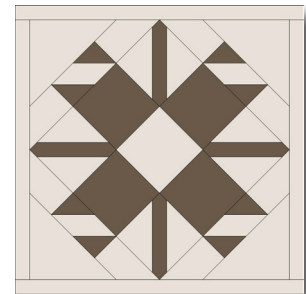

*Jane Stickle Colorway*

*\*The actual required width for Unit A and Unit B units is ¾". The increased width specified above allows for squaring the block to exactly 5½".*

### Assembly:

- Using templates on Page L2-2, foundation piece sections. Arrange and sew together.
- Join Unit B to the right side of the block, and then the left.
- Join Unit A to the top of the block and then the bottom. Square up block to measure 5½" x 5½" square.

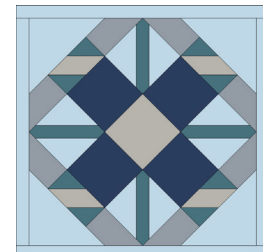
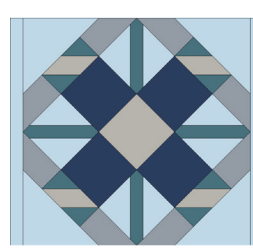
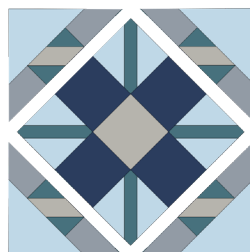
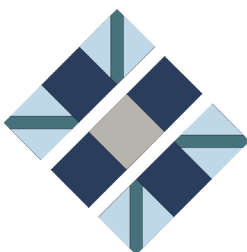

SET PRINTER TO "ACTUAL SIZE" WHEN PRINTING THIS PAGE.

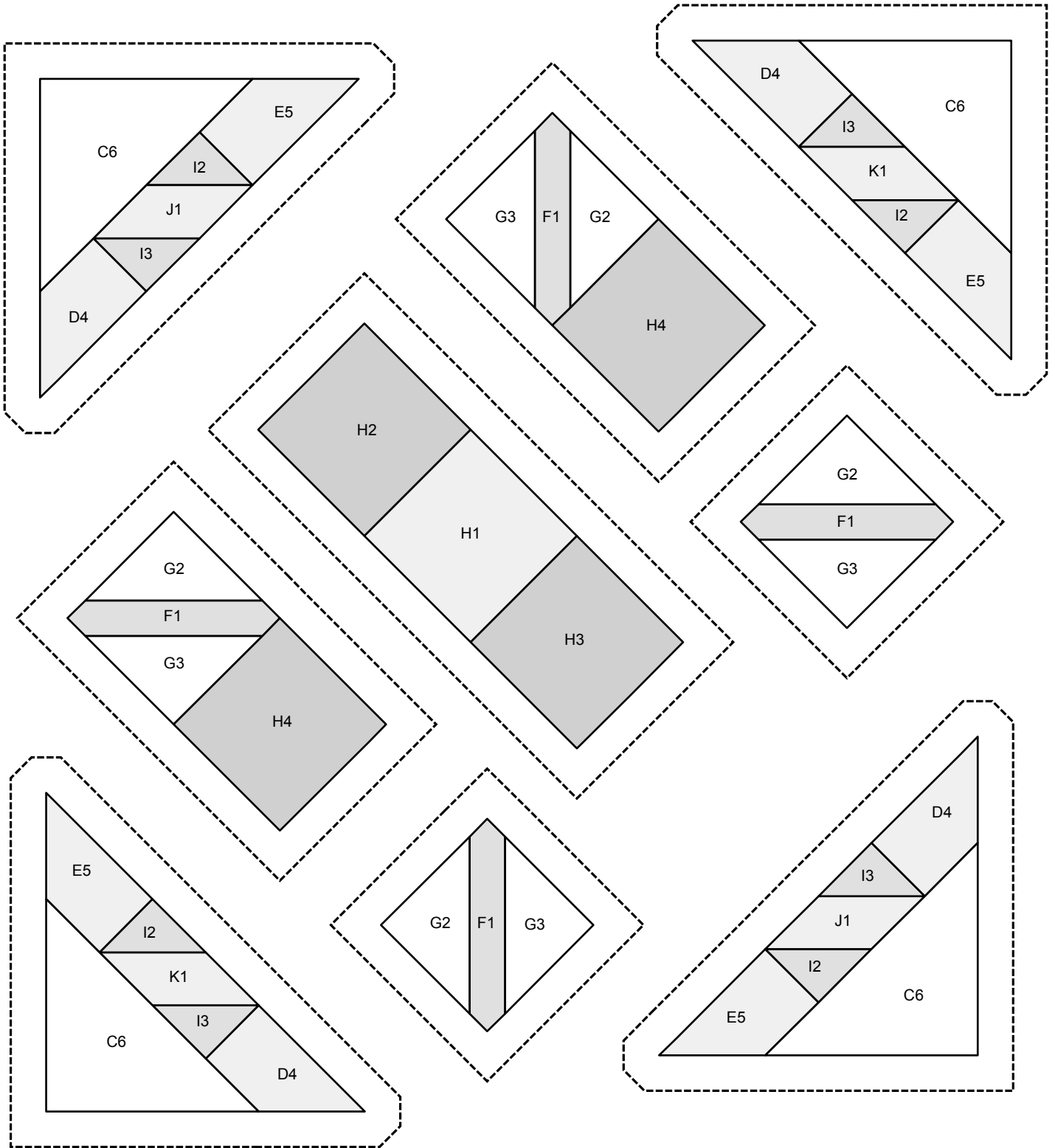

2"

SET PRINTER TO "ACTUAL SIZE" WHEN PRINTING THIS PAGE.

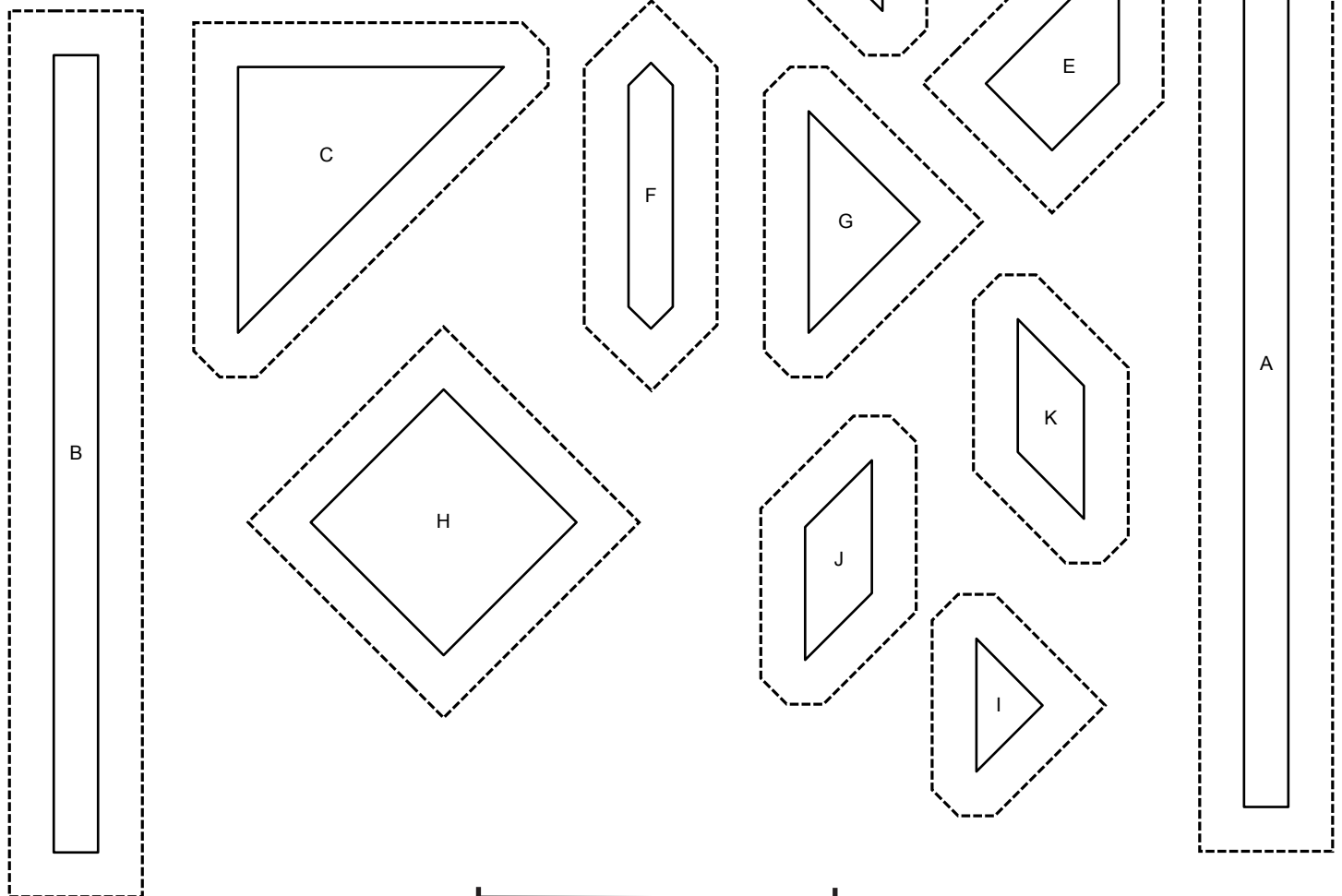
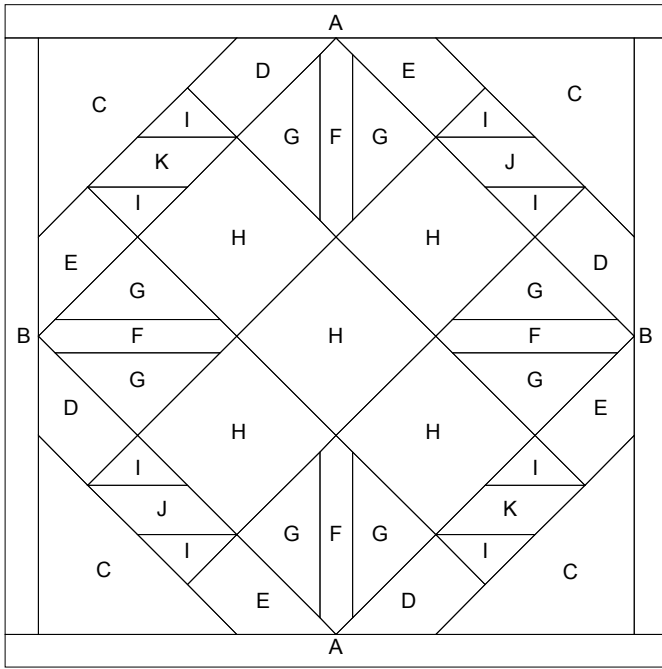

2"



## The Jane Stickle Quilt - Block L3

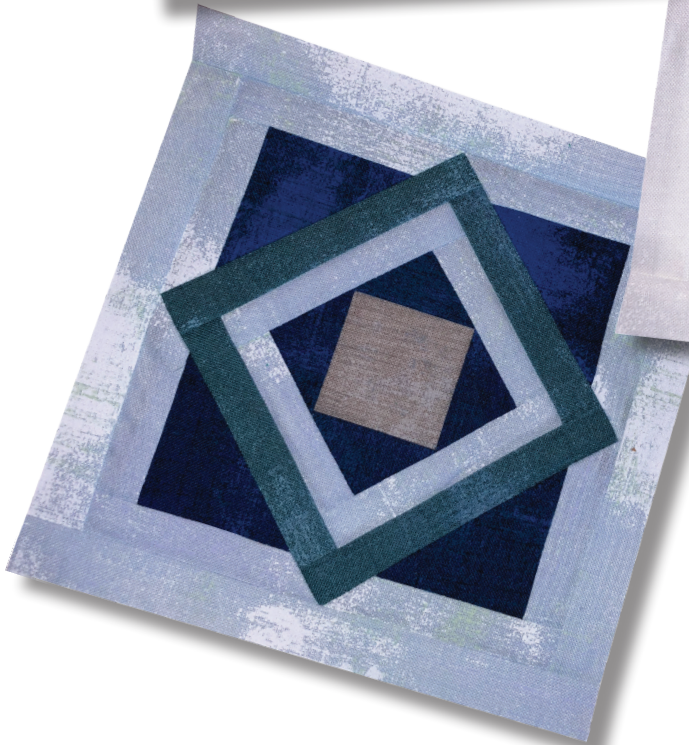

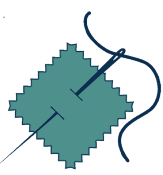

### What you need:

Patches	Quantity/size
A*	(2) 1" x 6"
B*	(2) 1" x 5"
C	(2) 1½" x 3½"
D	(2) 1½" x 3½"
E	(2) 1½" x 3"
F	(2) 1½" x 3"
G	(2) 3" x 3" - cut once diagonally
H	(2) 1½" x 4"
I	(2) 1½" x 3½" - green (2) 1½" x 3½" - light blue
J	(2) 1½" x 2½"
K	(1) 3" x 3" - cut twice diagonally
L	(1) 2" x 2"

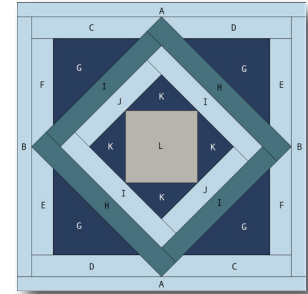

*Hobbystash Colorway*

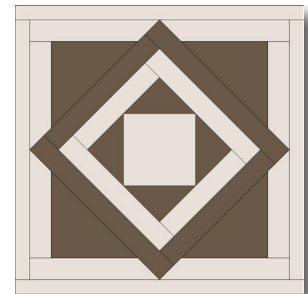

*Jane Stickle Colorway*

*\*The actual required width for Unit A and Unit B units is ¾". The increased width specified above allows for squaring the block to exactly 5½".*

### Assembly:

1. Using templates on Page L3-2, foundation piece sections. Arrange and sew together.
2. Join Unit B to the right side of the block, and then the left.
3. Join Unit A to the top of the block and then the bottom. Square up block to measure 5½" x 5½" square.

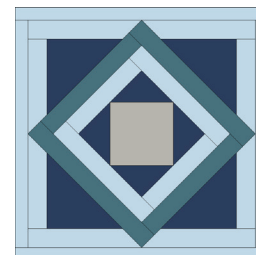
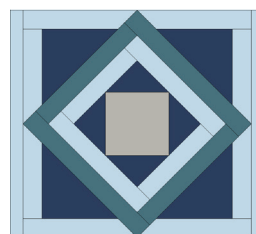
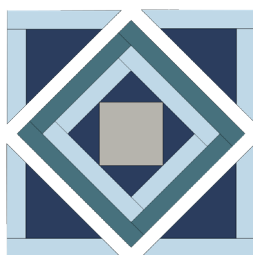

SET PRINTER TO "ACTUAL SIZE" WHEN PRINTING THIS PAGE.

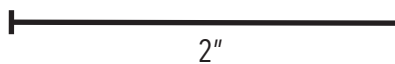
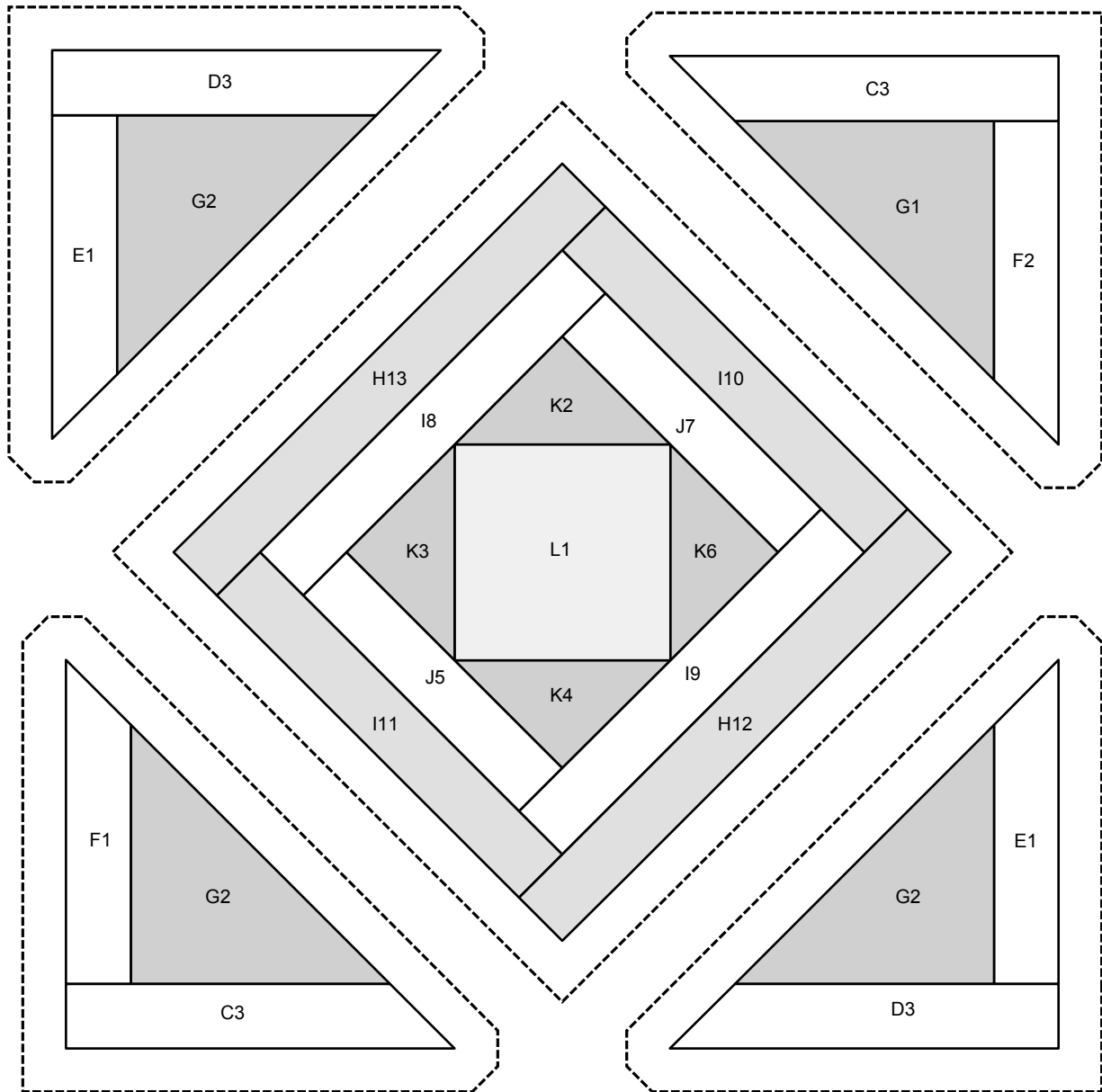

SET PRINTER TO "ACTUAL SIZE" WHEN PRINTING THIS PAGE.

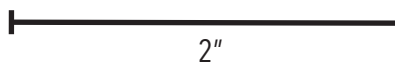
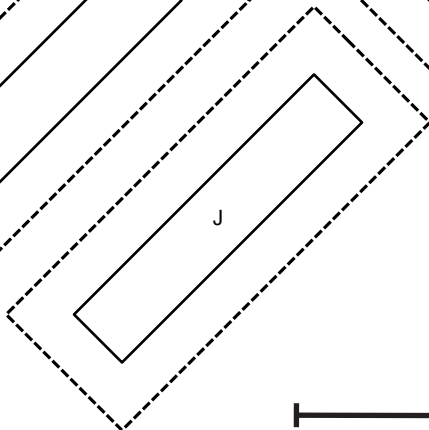
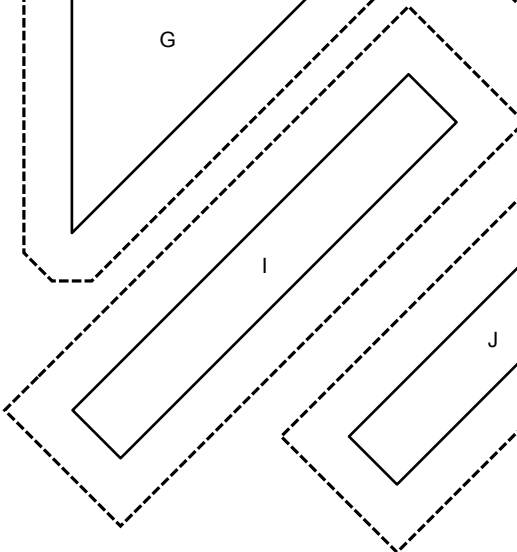
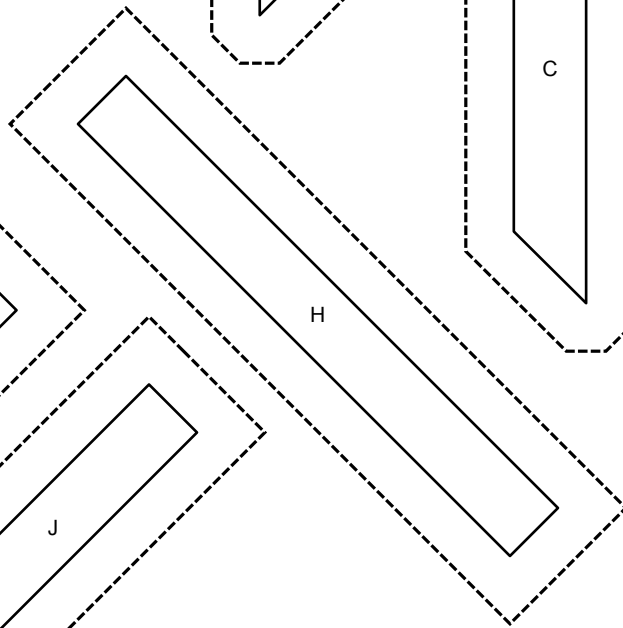
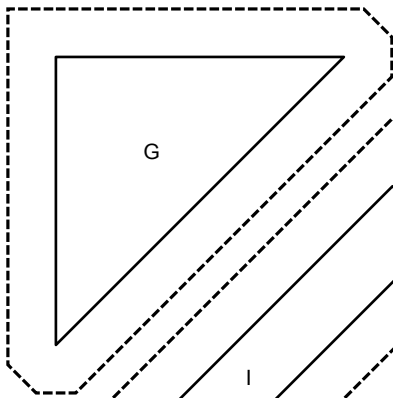
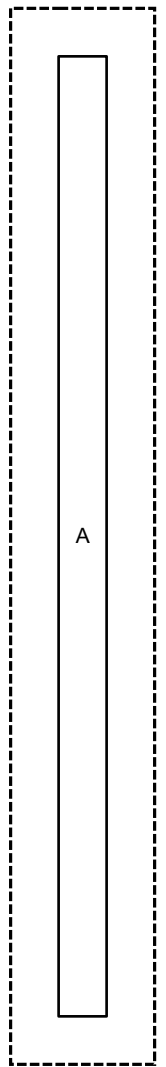
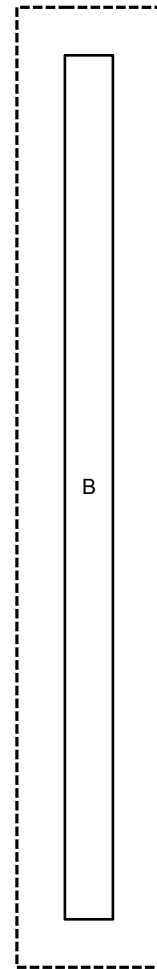
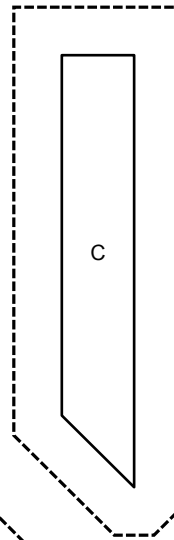
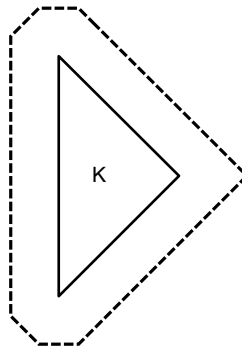
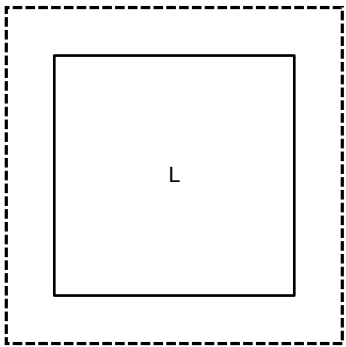
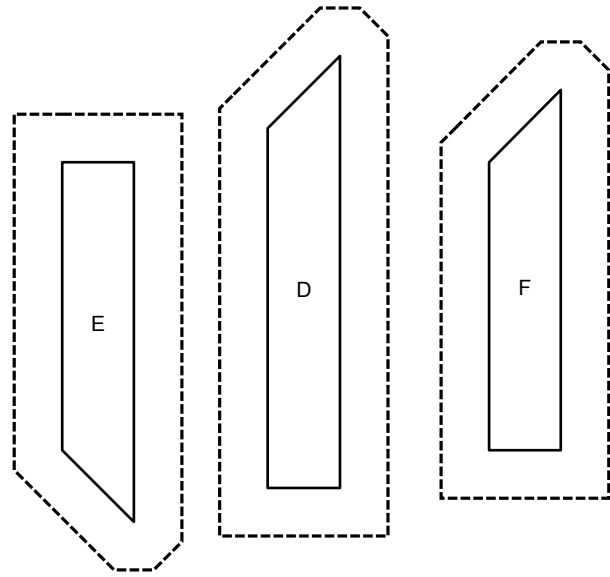
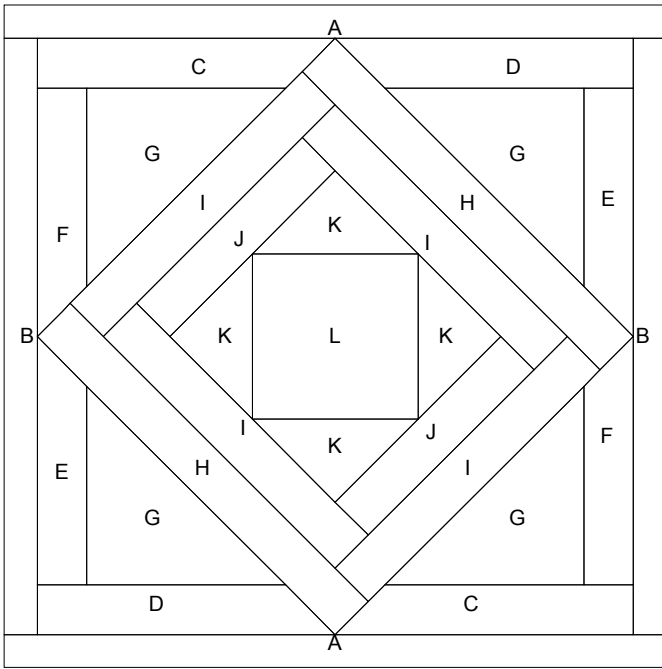



## The Jane Stickle Quilt - Block L4

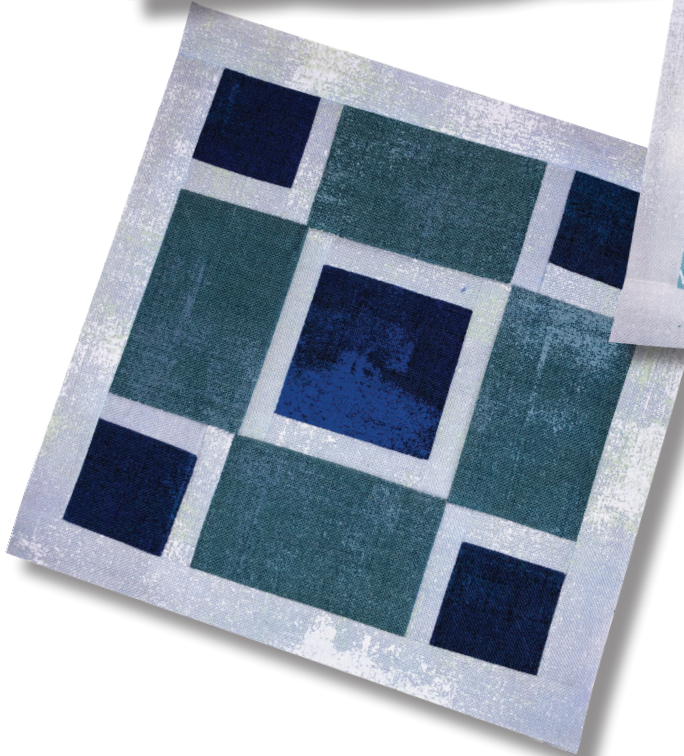
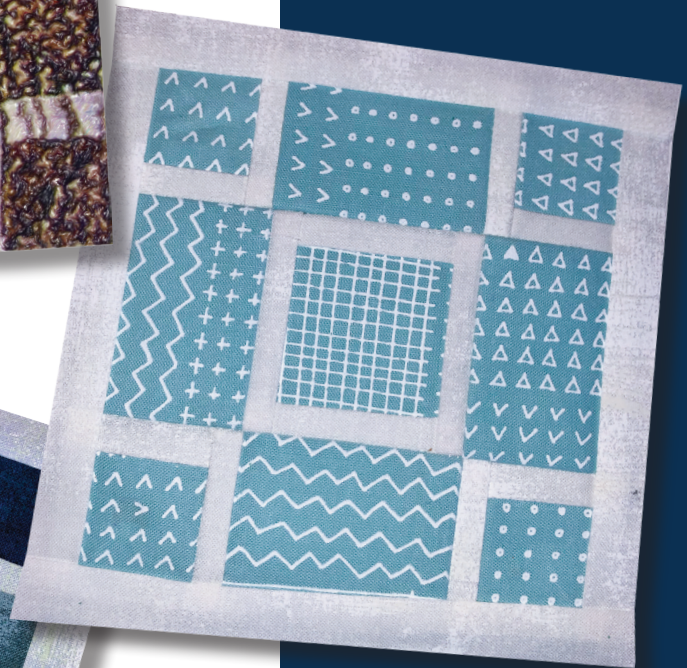

### What you need:

Patches	Quantity/size
A*	(2) 1" x 6"
B*	(2) 1" x 5"
C	(4) 2" x 2"
D	(4) 1" x 2"
E	(4) 2" x 3"
F	(4) 1" x 2"
G	(2) 1" x 3"
H	(2) 1" x 2½"
I	(1) 2½" x 2½"

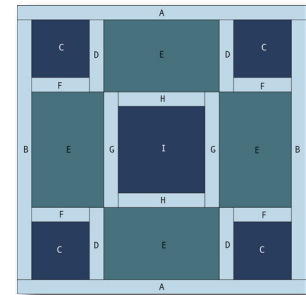

*Hobbystash Colorway*

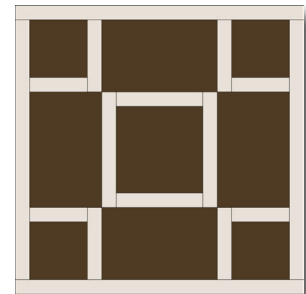

*Jane Stickle Colorway*

*\*The actual required width for Unit A and Unit B units is ¾". The increased width specified above allows for squaring the block to exactly 5½".*

### Assembly:

1. Using templates on Page L4-2, foundation piece sections. Arrange and sew together.
2. Join Unit B to the right side of the block, and then the left.
3. Join Unit A to the top of the block and then the bottom. Square up block to measure 5½" x 5½" square.

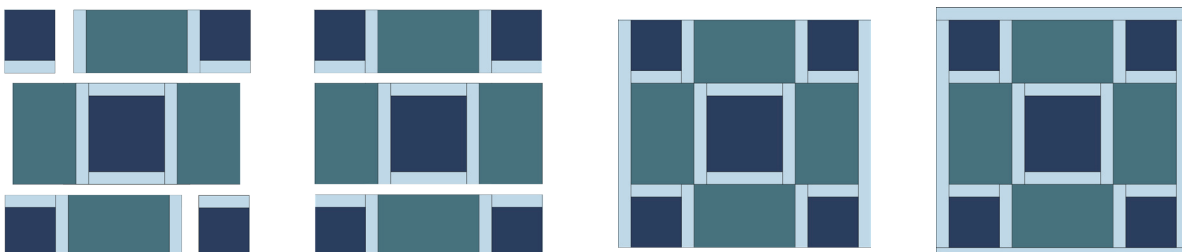

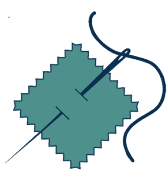

SET PRINTER TO "ACTUAL SIZE" WHEN PRINTING THIS PAGE.

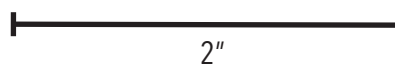
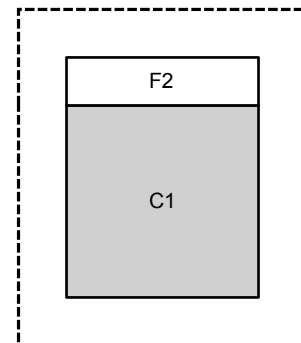
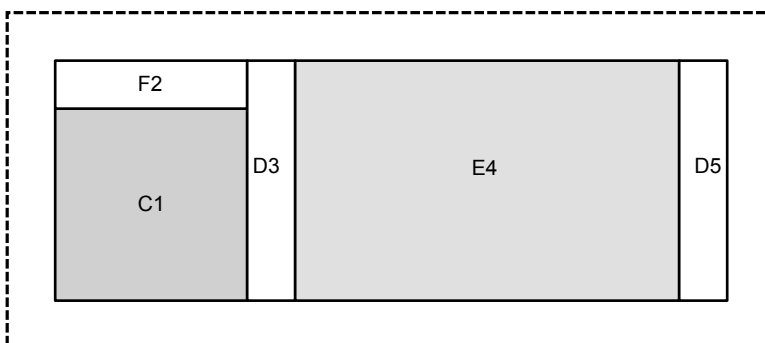
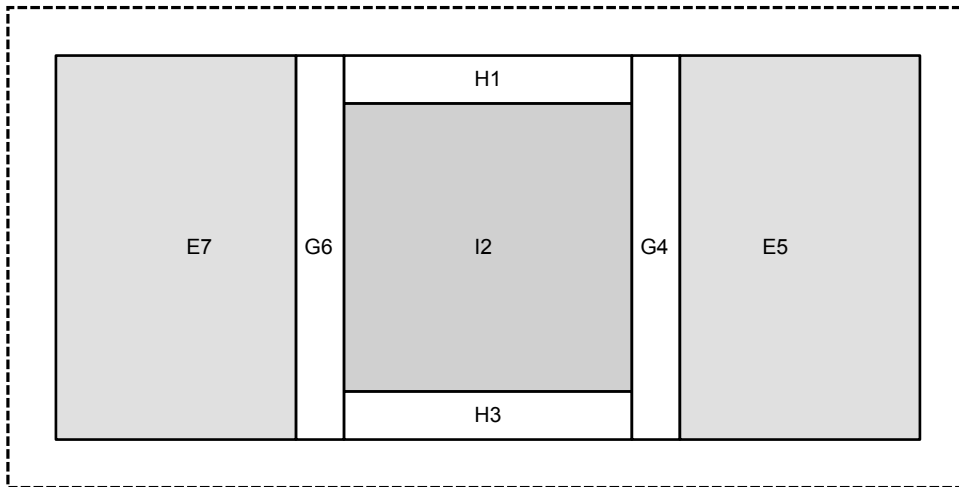
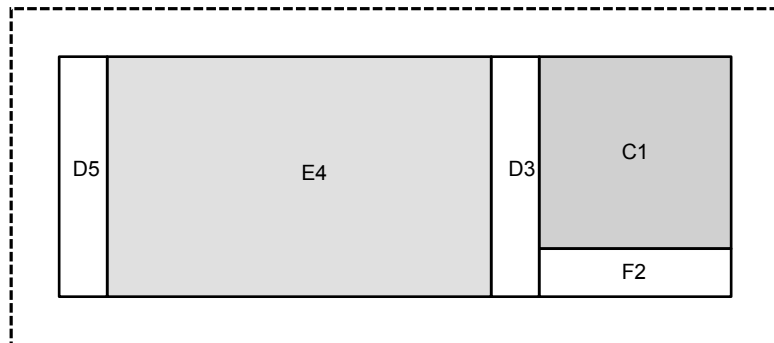
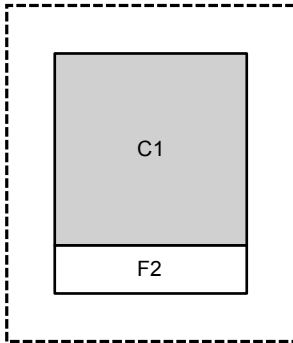

SET PRINTER TO "ACTUAL SIZE" WHEN PRINTING THIS PAGE.

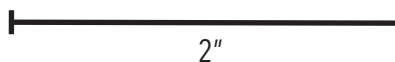
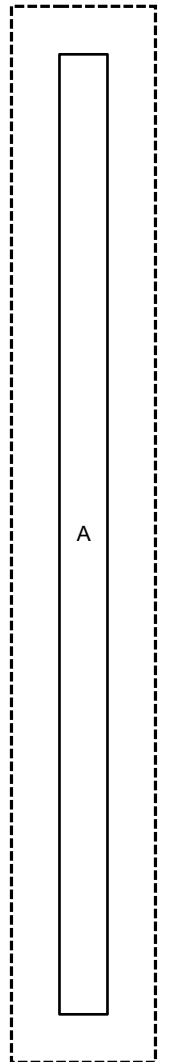
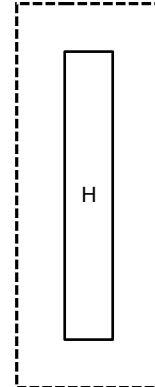
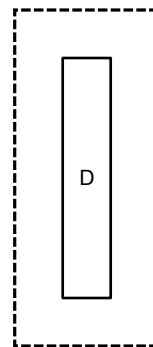
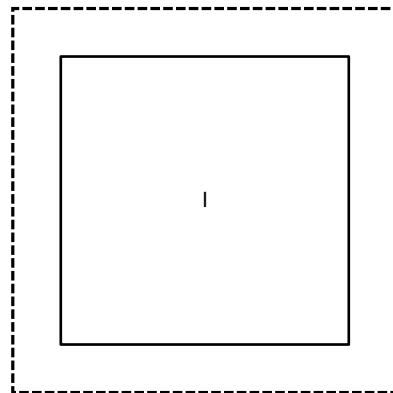
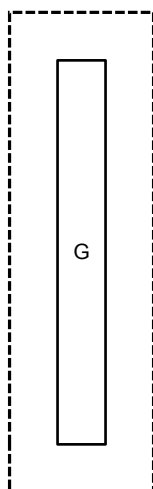
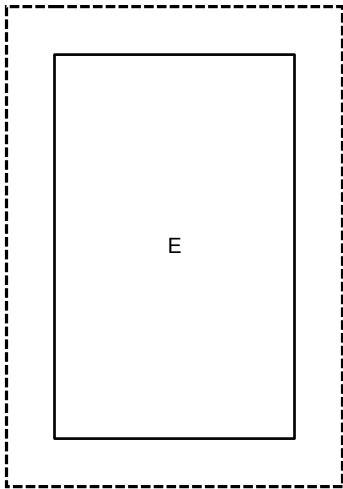
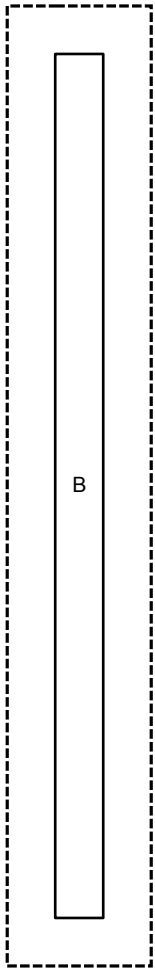
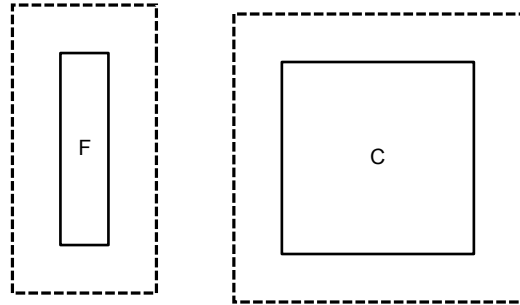
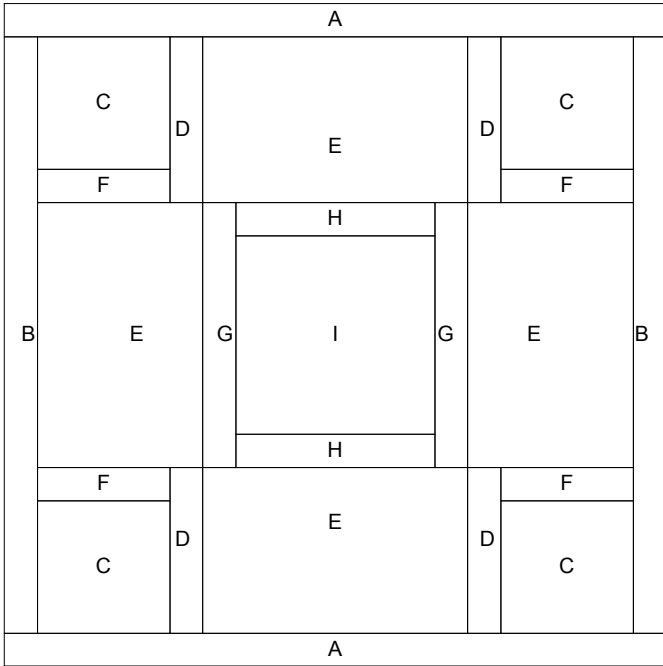



## The Jane Stickle Quilt - Block L5

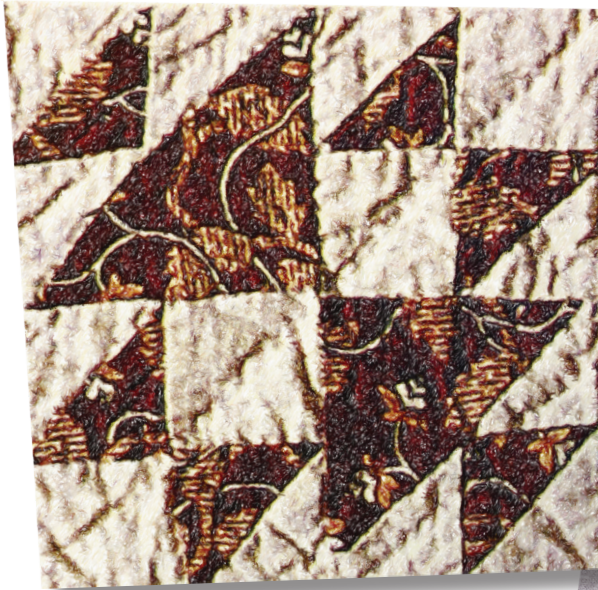

### What you need:

Patches	Quantity/size
A*	(2) 1" x 6"
B*	(2) 1" x 5"
C	(5) 2½" x 2½" - light blue, cut once diagonally (3) 2½" x 2½" - navy, cut once diagonally
D	(2) 2" x 2" - light blue (2) 2" x 2" - beige
E	(1) 3½" x 3½" - cut once diagonally

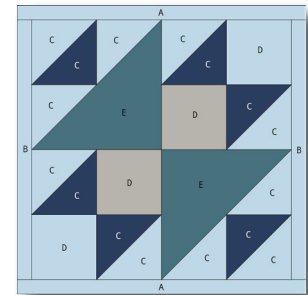

*Hobbystash Colorway*

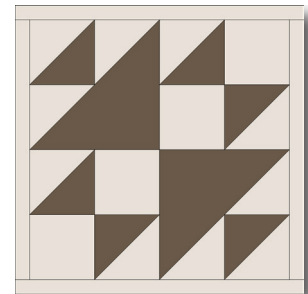

*Jane Stickle Colorway*

*\*The actual required width for Unit A and Unit B units is ¾". The increased width specified above allows for squaring the block to exactly 5½".*

### Assembly:

1. Using templates on Page L5-2, foundation piece sections. Arrange and sew together.
2. Join Unit B to the right side of the block, and then the left.
3. Join Unit A to the top of the block and then the bottom. Square up block to measure 5½" x 5½" square.

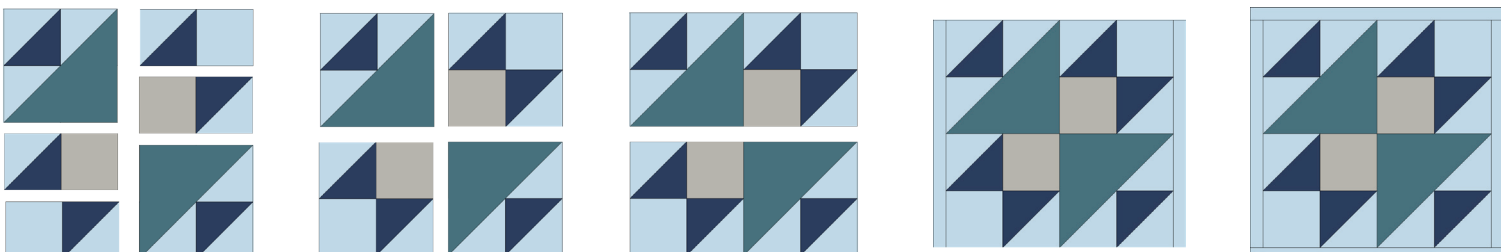

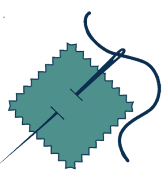

SET PRINTER TO "ACTUAL SIZE" WHEN PRINTING THIS PAGE.

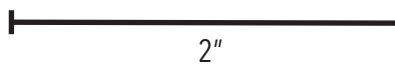
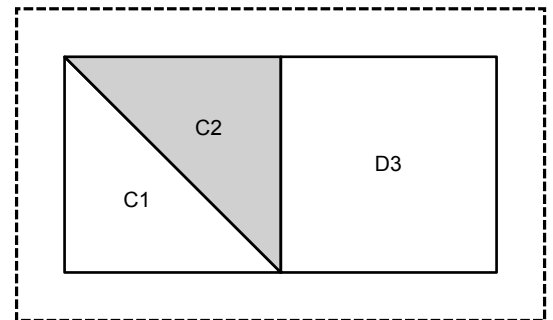
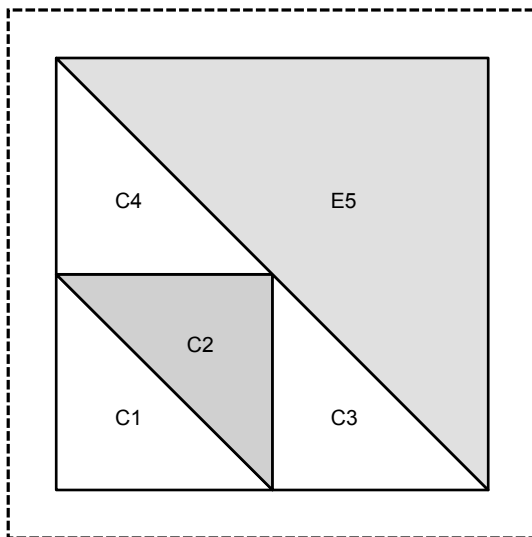
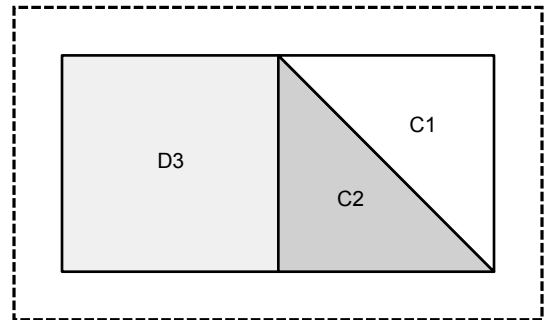
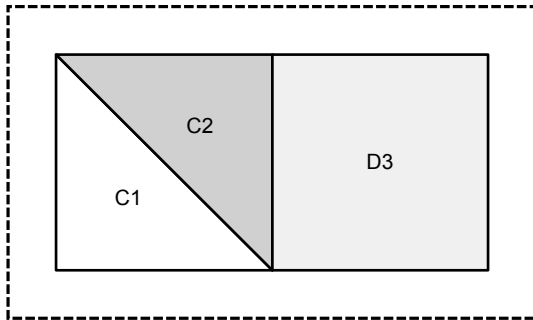
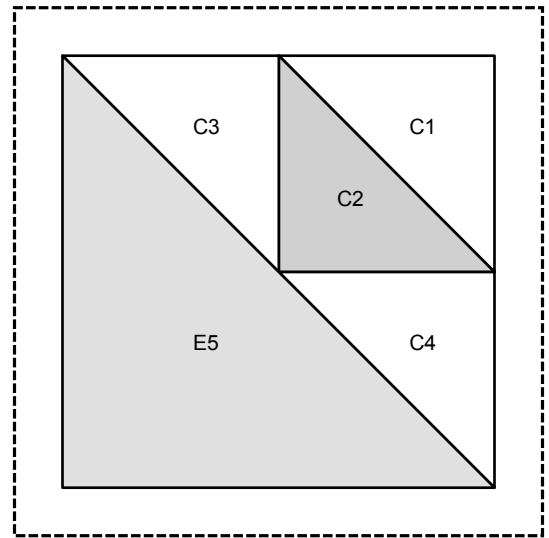
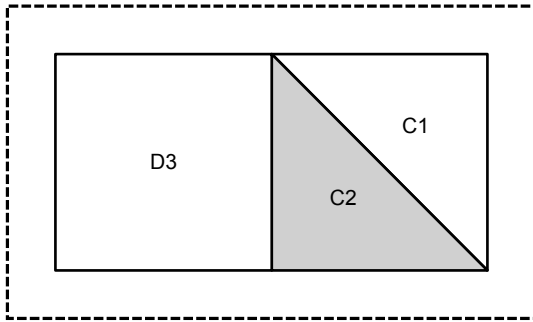

SET PRINTER TO "ACTUAL SIZE" WHEN PRINTING THIS PAGE.

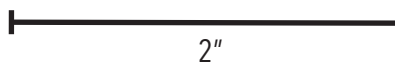
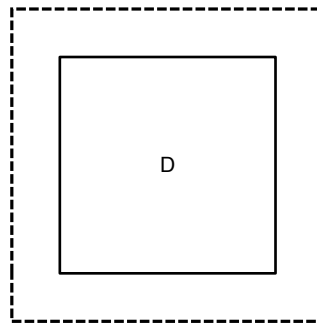
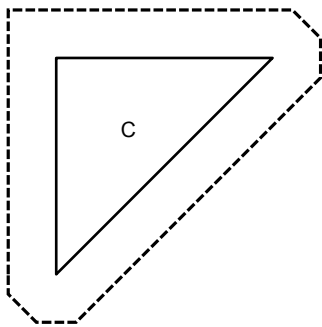
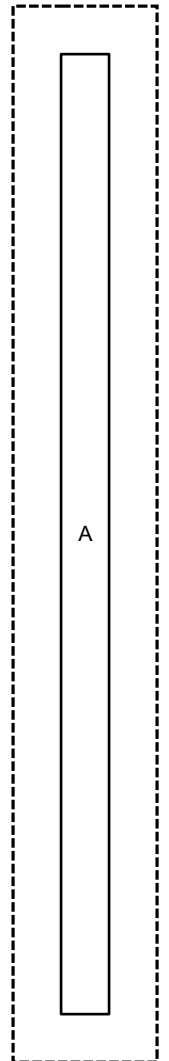
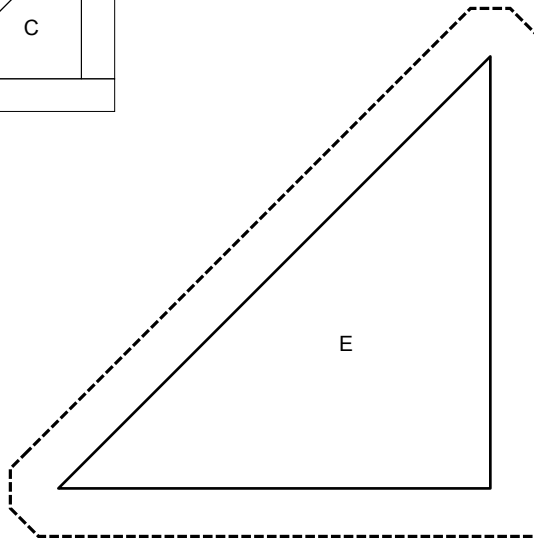
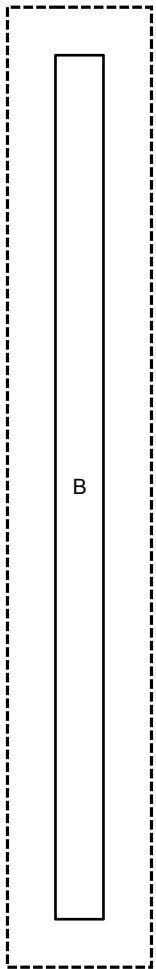
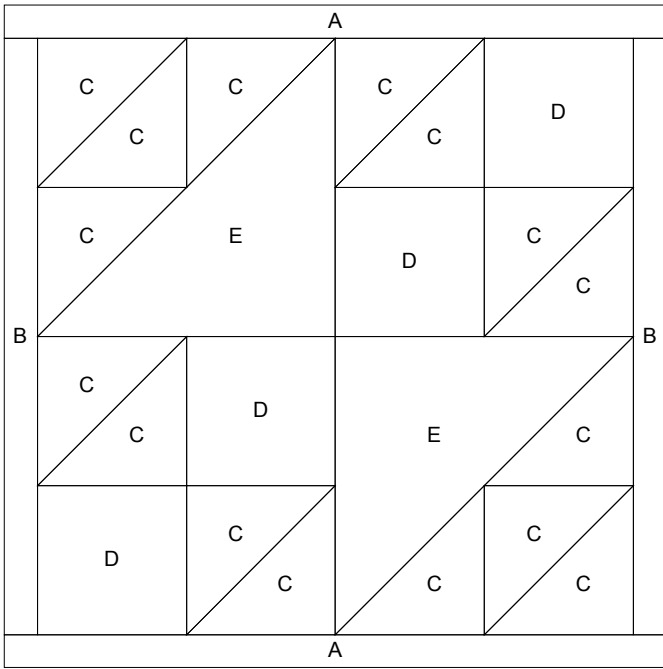



## The Jane Stickle Quilt - Block L6





### What you need:

Patches	Quantity/size	Patches	Quantity/Size
A*	(2) 1" x 6"	H	(2) 1" x 4½"
B*	(2) 1" x 5"	I	(2) 1" x 4"
C	(2) 1½" x 5½"	J	(4) 1" x 1" - light blue (4) 1" x 1" - navy
D	(8) 1" x 1½"	K	(4) 1½" x 2"
E	(4) 1" x 2"	L	(2) 1½" x 4½"
F	(4) 1" x 2"	M	(1) 1½" x 2½"
G	(2) 1½" x 1½" - navy (8) 1½" x 1½" - green		

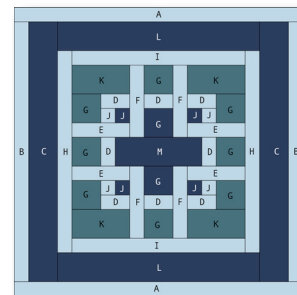

*Hobby Stash Colorway*

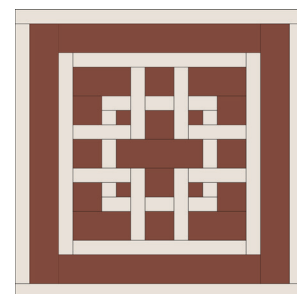

*Jane Stickle Colorway*

*\*The actual required width for Unit A and Unit B units is ¾". The increased width specified above allows for squaring the block to exactly 5½".*

### Assembly:

1. Using templates on Page L6-2, foundation piece sections. Arrange and sew together.
2. Join Unit B to the right side of the block, and then the left.
3. Join Unit A to the top of the block and then the bottom. Square up block to measure 5½" x 5½" square.

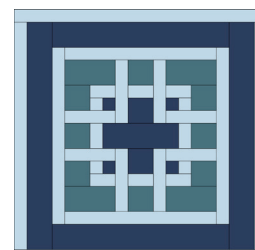
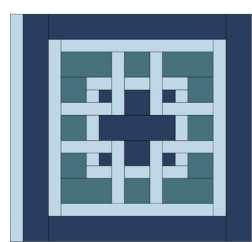
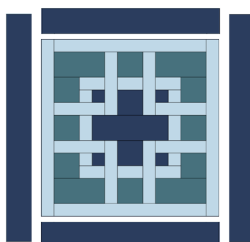
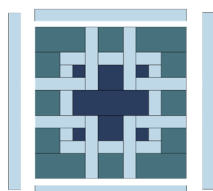
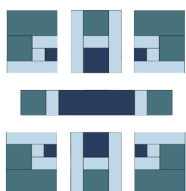

SET PRINTER TO "ACTUAL SIZE" WHEN PRINTING THIS PAGE.

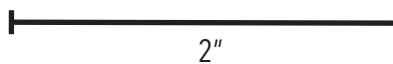
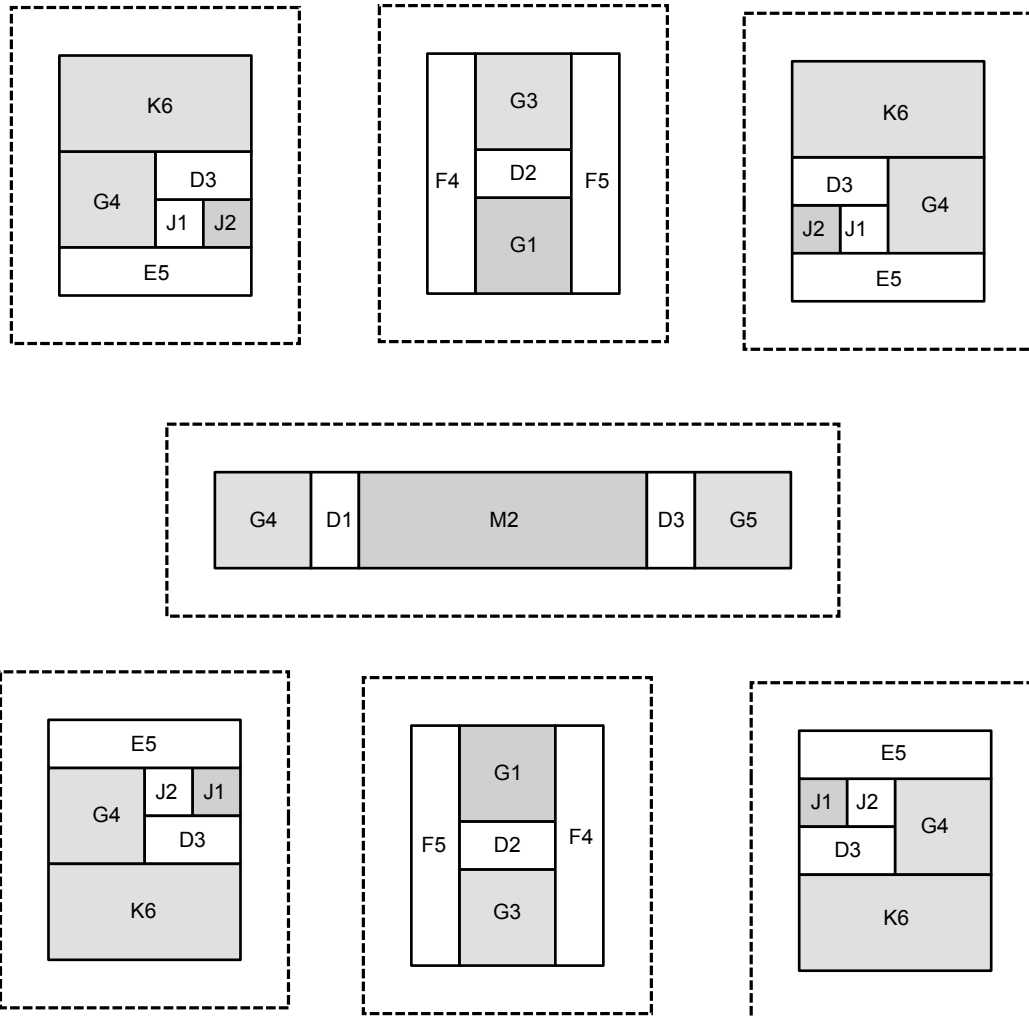

SET PRINTER TO "ACTUAL SIZE" WHEN PRINTING THIS PAGE.

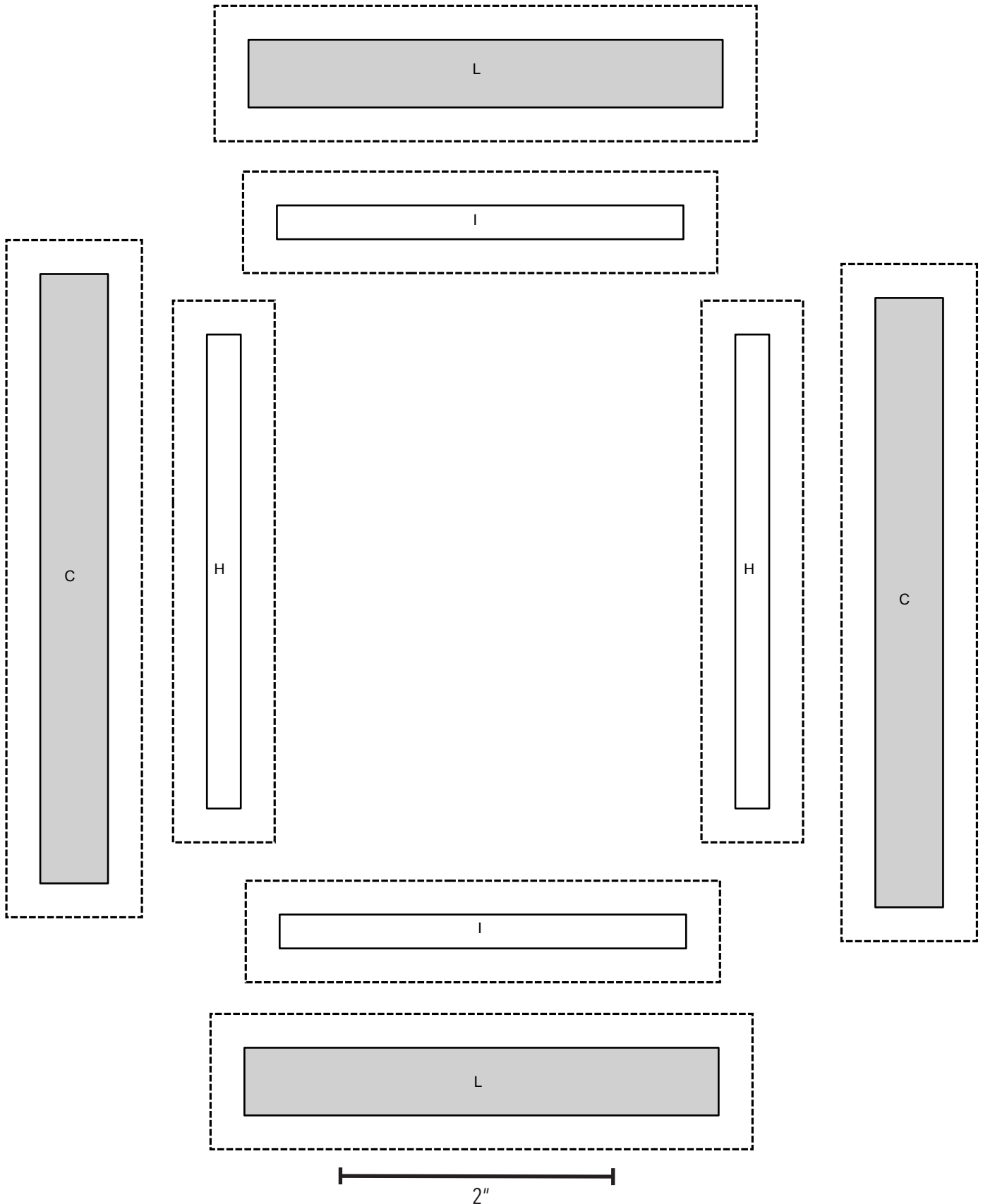

SET PRINTER TO "ACTUAL SIZE" WHEN PRINTING THIS PAGE.

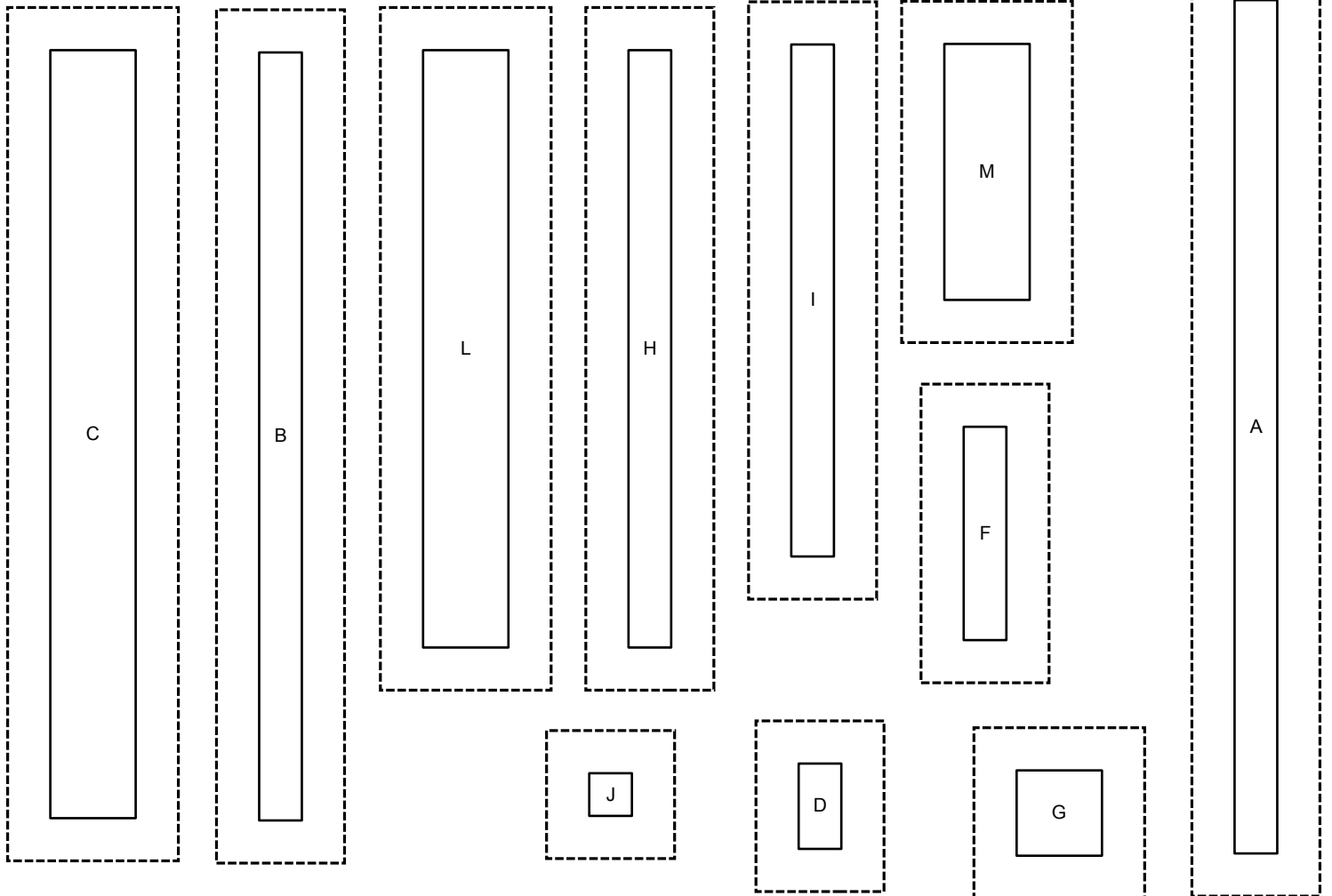
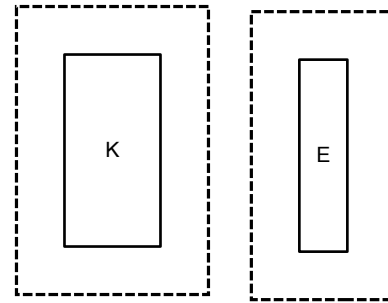
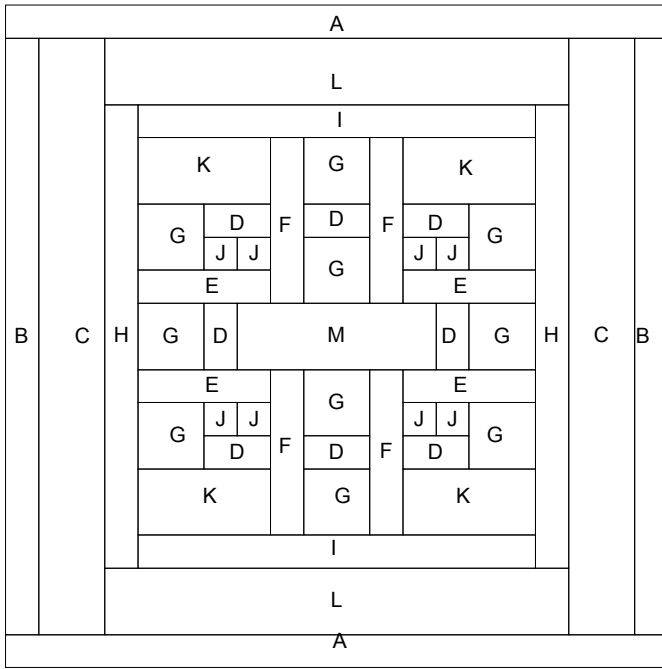

2"

## The Jane Stickle Quilt - Block L7





### What you need:

Patches	Quantity/size
A*	(2) 1" x 6"
B*	(2) 1" x 5"
C	(4) 2½" x 2½"
D	(4) 1½" x 2½"
E	(4) 2" x 2½"
F	(2) 2" x 2" - cut once diagonally
G	(1) 2" x 2"

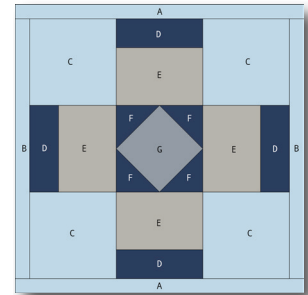

Hobby Stash Colorway

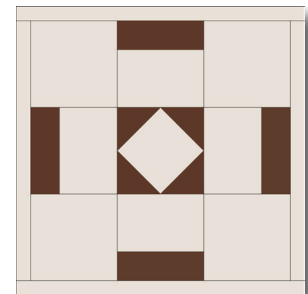

Jane Stickle Colorway

*\*The actual required width for Unit A and Unit B units is ¾". The increased width specified above allows for squaring the block to exactly 5½".*

### Assembly:

1. Using templates on Page L7-2, foundation piece sections. Arrange and sew together.
2. Join Unit B to the right side of the block, and then the left.
3. Join Unit A to the top of the block and then the bottom. Square up block to measure 5½" x 5½" square.

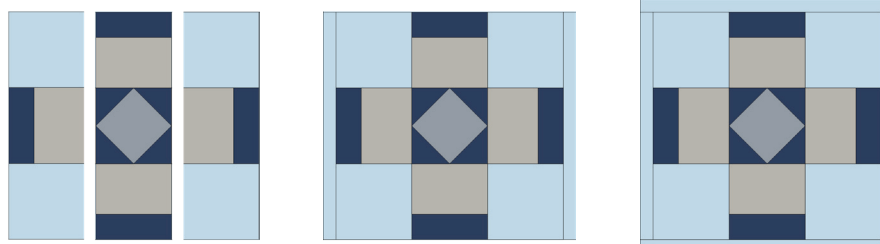

SET PRINTER TO "ACTUAL SIZE" WHEN PRINTING THIS PAGE.

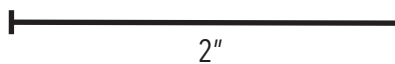
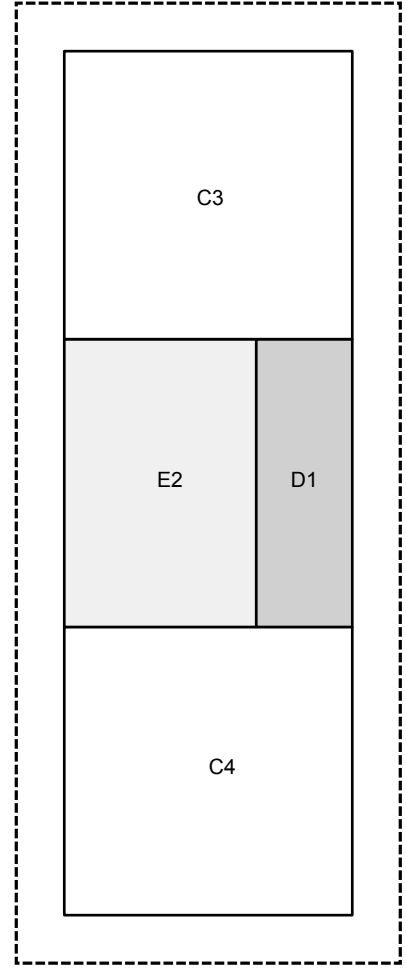
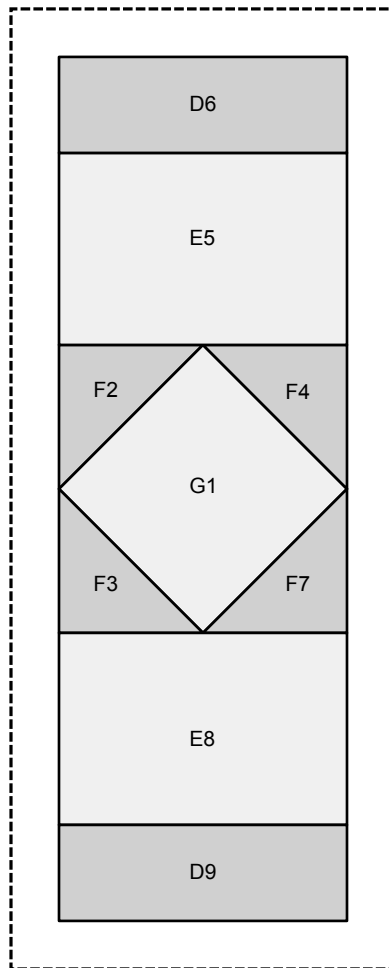
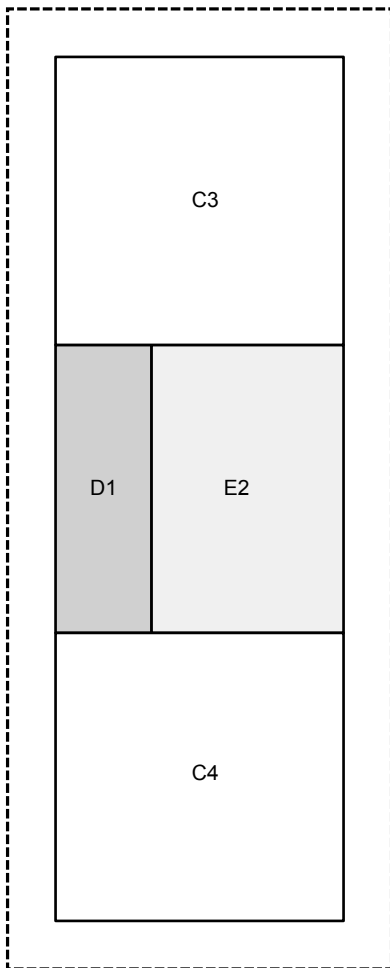

SET PRINTER TO "ACTUAL SIZE" WHEN PRINTING THIS PAGE.

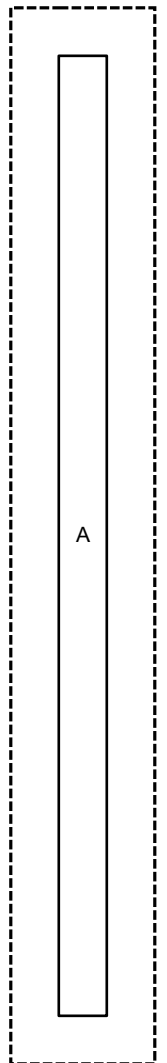
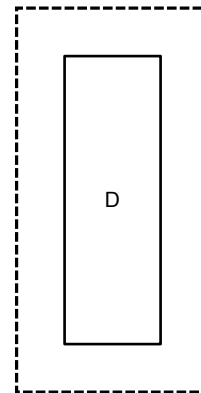
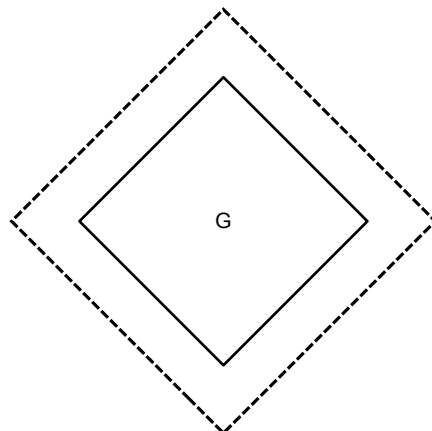
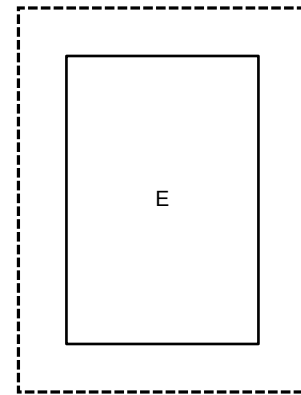
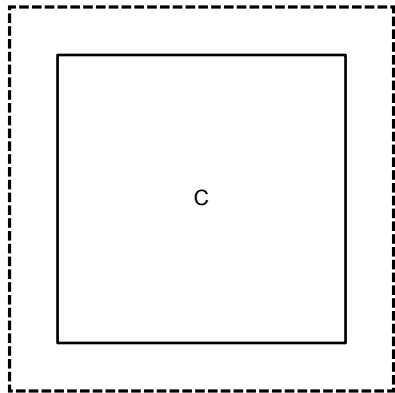
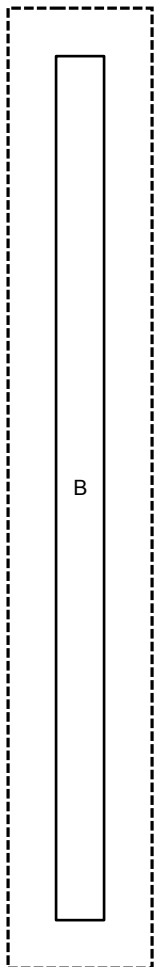
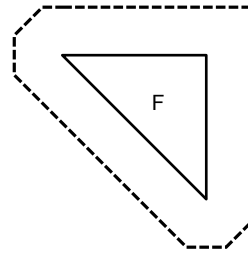
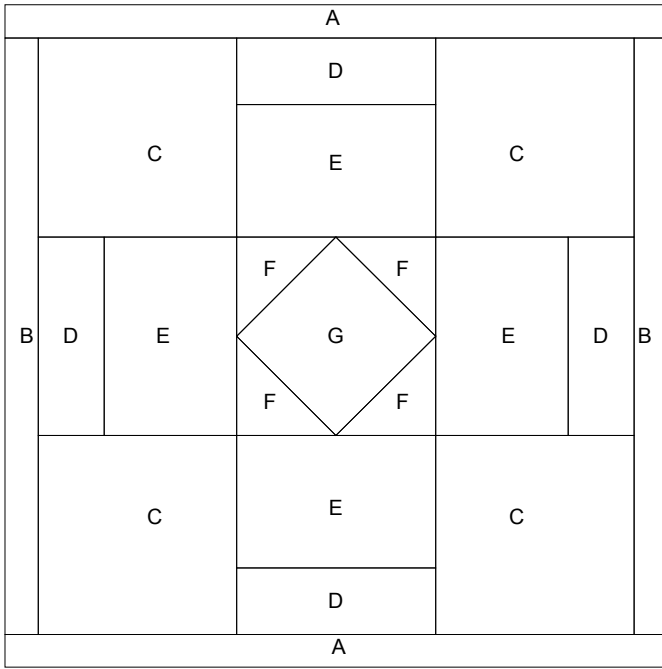

2"

## The Jane Stickle Quilt - Block L8

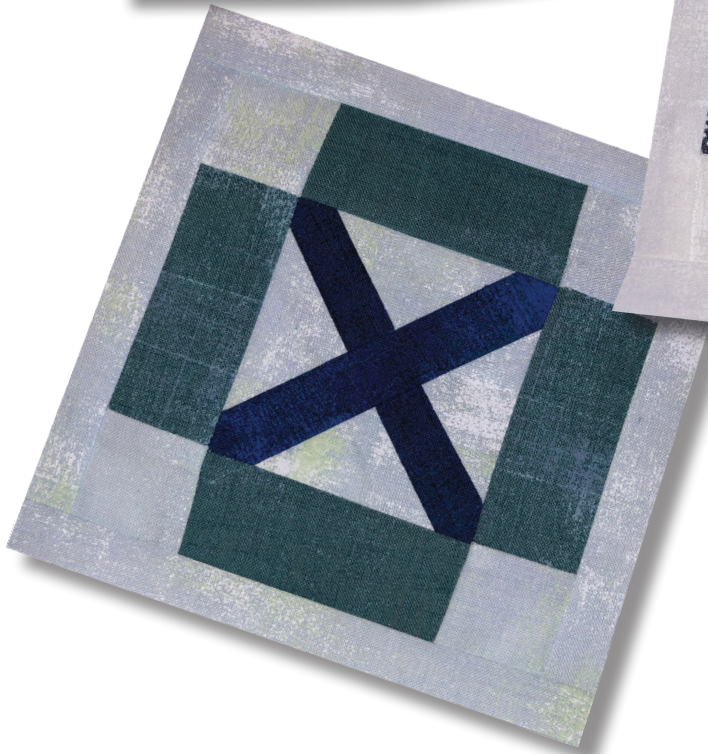

### What you need:

Patches	Quantity/size
A*	(2) 1" x 6"
B*	(2) 1" x 5"
C	(4) 2" x 2"
D	(4) 2" x 3½"
E	(1) 1½" x 5"
F	 (1) 3½" x 3½" - cut twice diagonally
G	(2) 1½" x 2½"

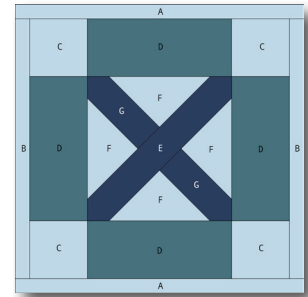

Hobbystash Colorway

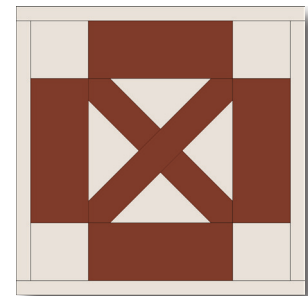

Jane Stickle Colorway

*\*The actual required width for Unit A and Unit B units is ¾". The increased width specified above allows for squaring the block to exactly 5½".*

### Assembly:

1. Using templates on Page L8-2, foundation piece sections. Arrange and sew together.
2. Join Unit B to the right side of the block, and then the left.
3. Join Unit A to the top of the block and then the bottom. Square up block to measure 5½" x 5½" square.

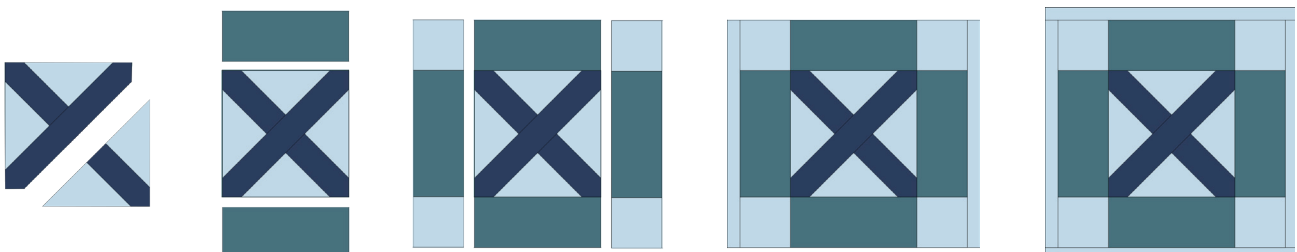



SET PRINTER TO "ACTUAL SIZE" WHEN PRINTING THIS PAGE.

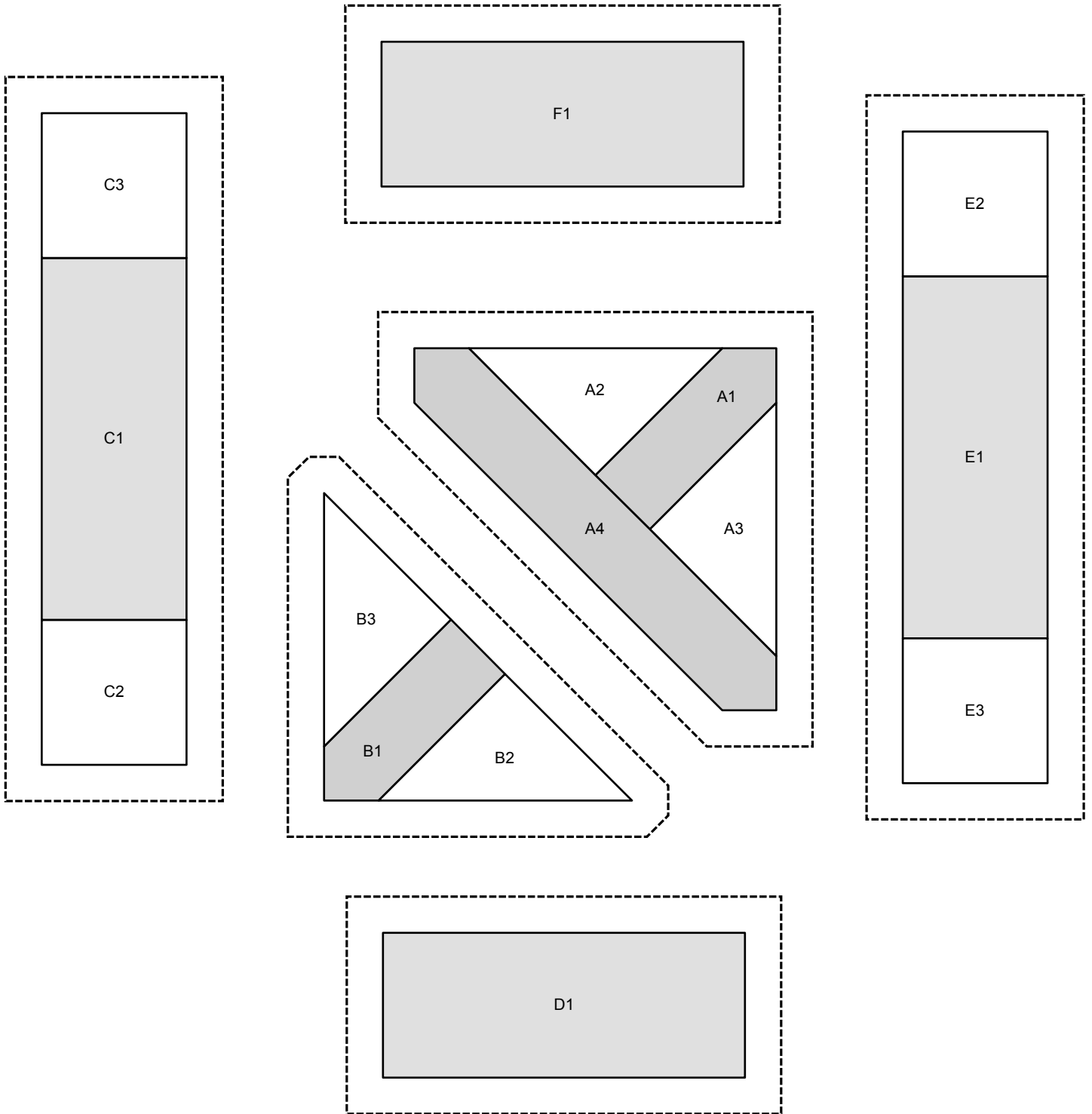

SET PRINTER TO "ACTUAL SIZE" WHEN PRINTING THIS PAGE.

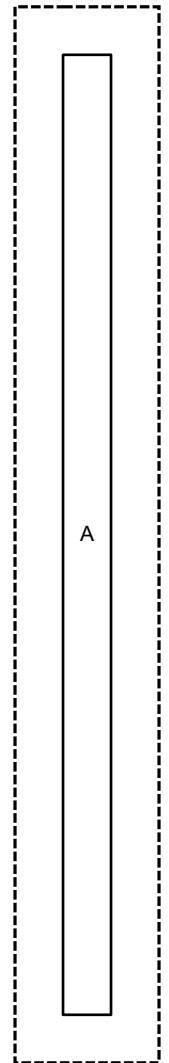
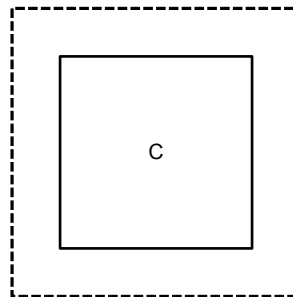
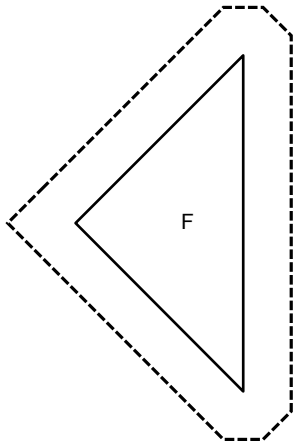
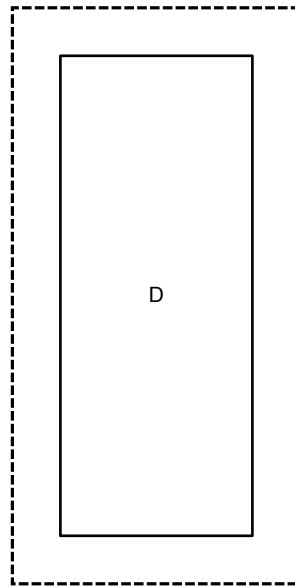
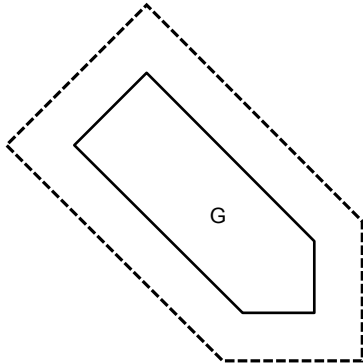
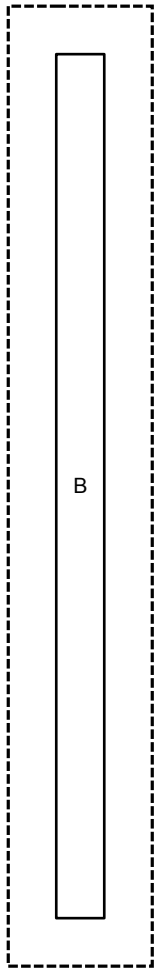
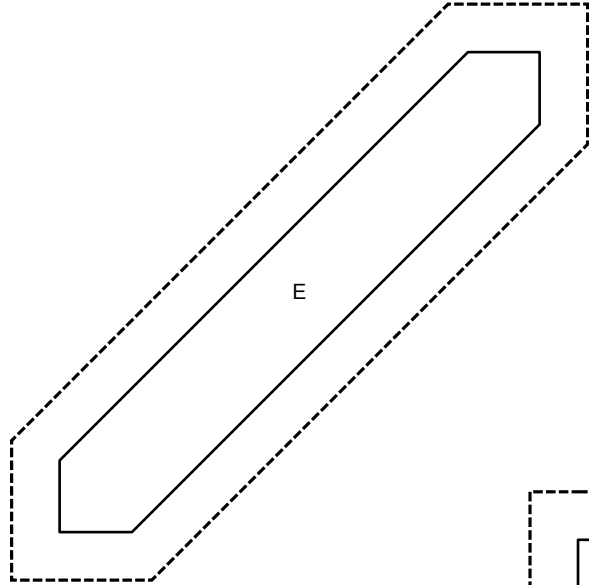
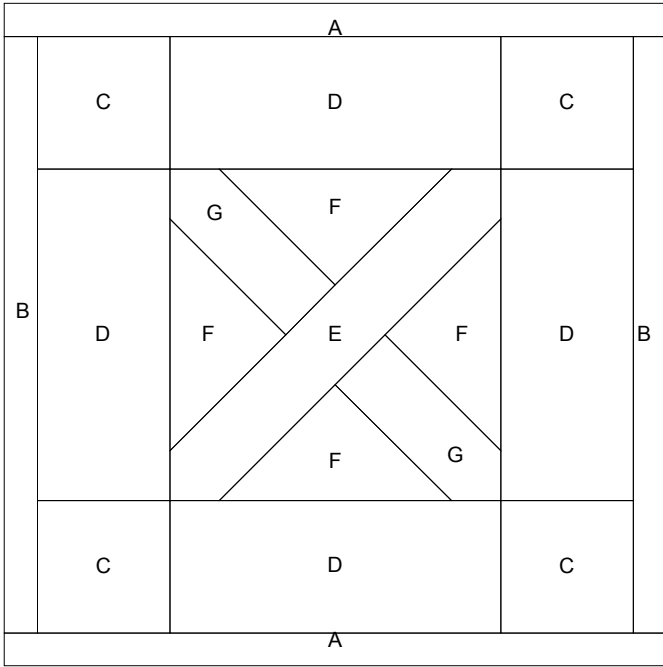

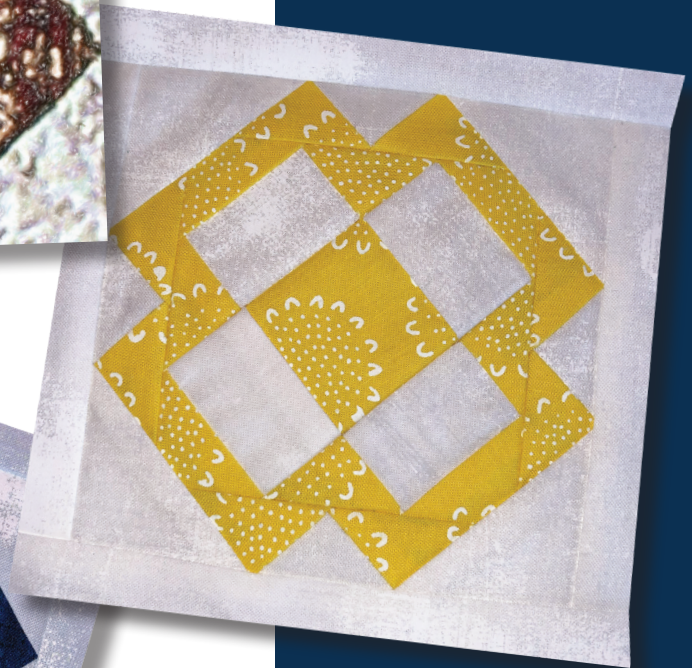
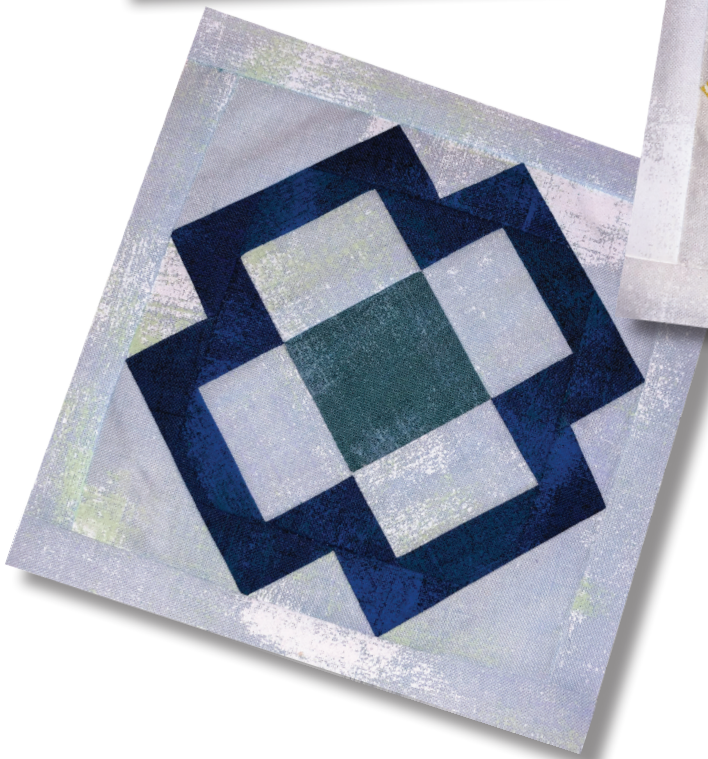
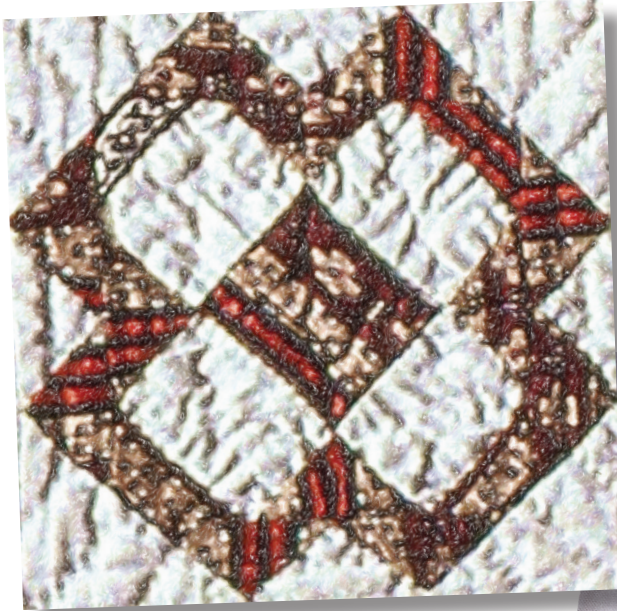

2"

## The Jane Stickle Quilt - Block L9



### What you need:

Patches	Quantity/size
A*	(2) 1" x 6"
B*	(2) 1" x 5"
C	 (2) 3" x 3" - cut once diagonally
D	 (1) 3" x 3" - cut twice diagonally, light blue (3) 3" x 3" - cut twice diagonally, navy
E	(4) 2" x 2½"
F	(4) 1½" x 3"
G	(1) 2½" x 2½"

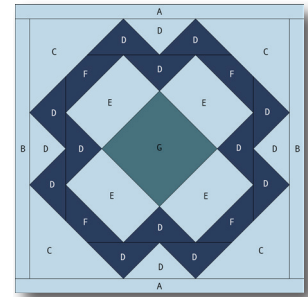

Hobbystash Colorway

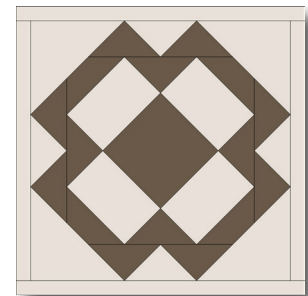

Jane Stickle Colorway

*\*The actual required width for Unit A and Unit B units is ¾". The increased width specified above allows for squaring the block to exactly 5½".*

### Assembly:

1. Using templates on Page L9-2, foundation piece sections. Arrange and sew together.
2. Join Unit B to the right side of the block, and then the left.
3. Join Unit A to the top of the block and then the bottom. Square up block to measure 5½" x 5½" square.

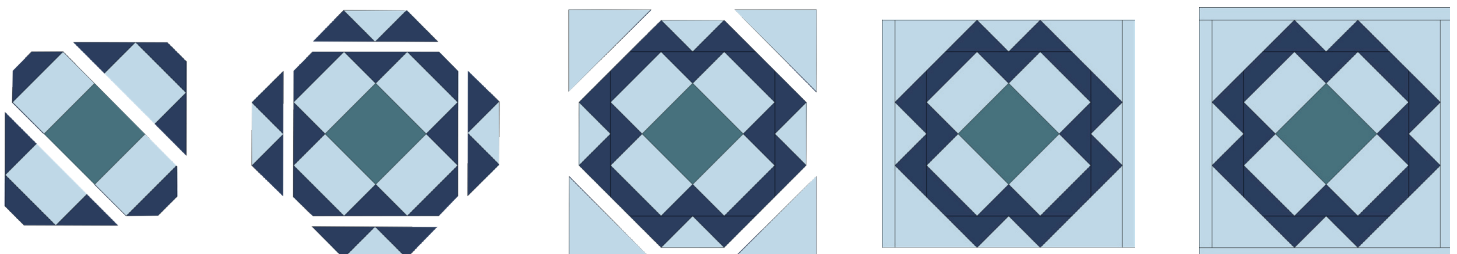

SET PRINTER TO "ACTUAL SIZE" WHEN PRINTING THIS PAGE.

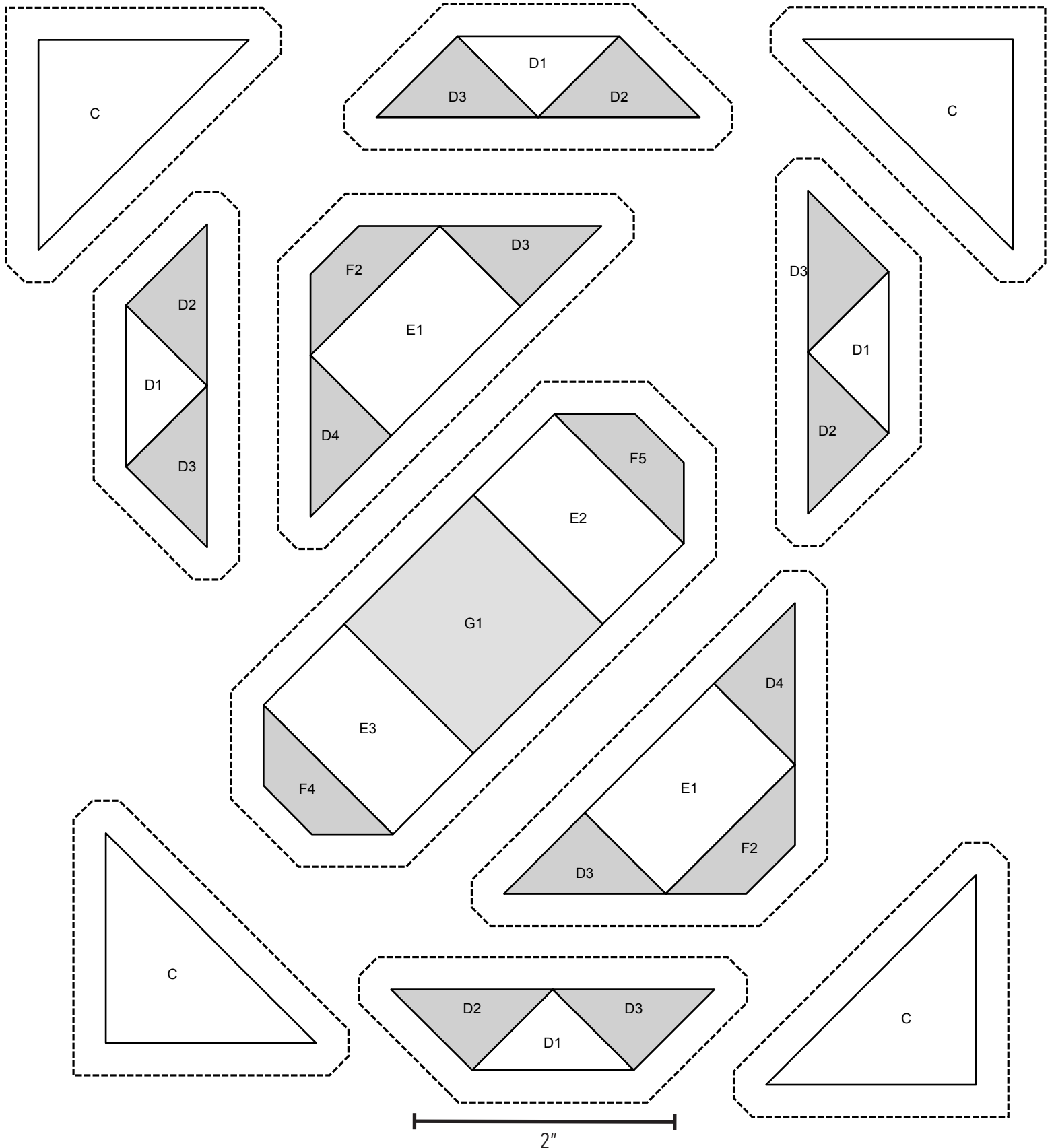



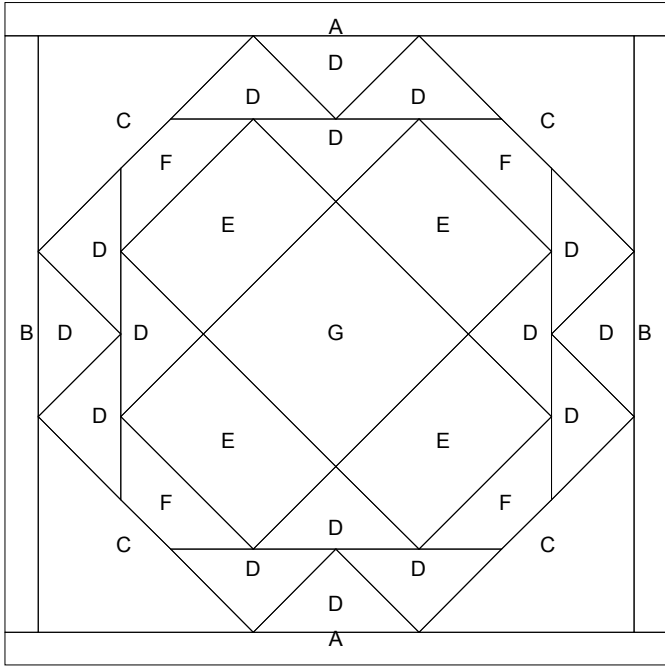

SET PRINTER TO "ACTUAL SIZE" WHEN PRINTING THIS PAGE.

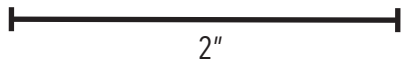
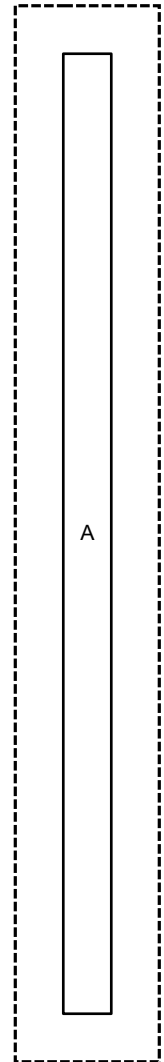
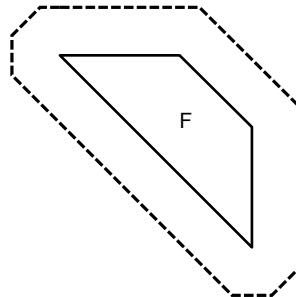
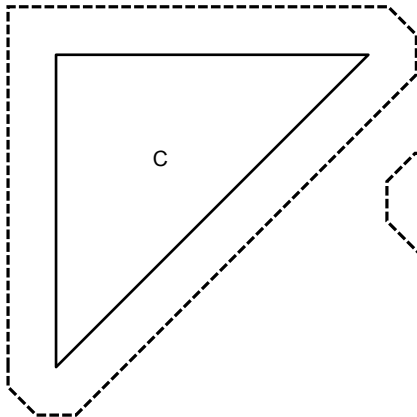
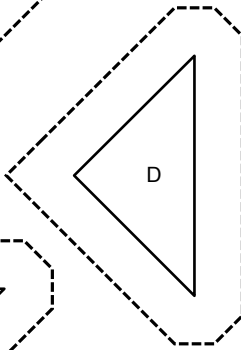
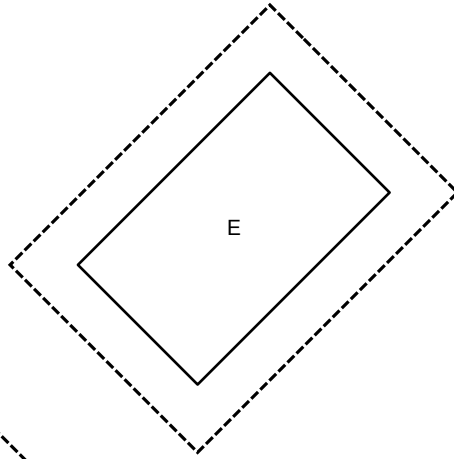
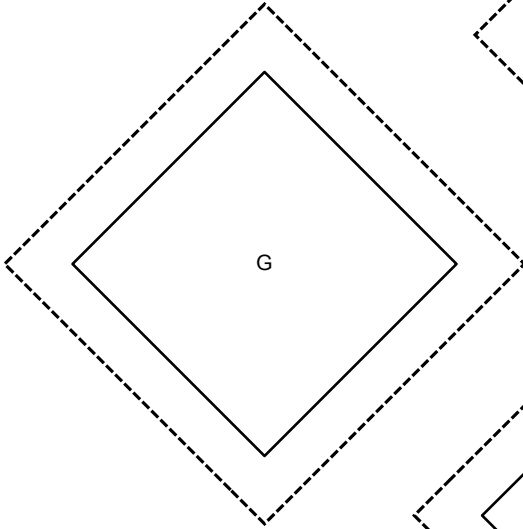
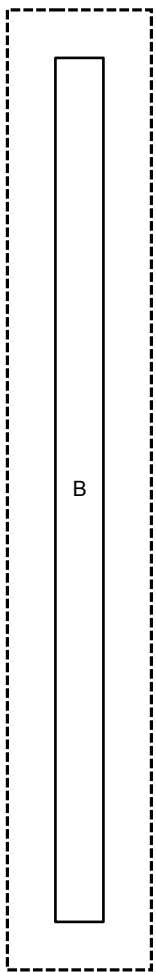

## The Jane Stickle Quilt - Block L10



### What you need:

Patches	Quantity/size
A*	(2) 1" x 6"
B*	(2) 1" x 5"
C, G	(4) 1½" x 2½"
D, F	(4) 1½" x 2½" - navy
E	(2) 1½" x 2½"
H, J, N, O	(8) 1½" x 2½"
I	(1) 2½" x 2½" - cut twice diagonally, light blue (2) 2½" x 2½" - cut twice diagonally, navy
K, M	(2) 1½" x 2½" - cut once diagonally
L	(4) 1½" x 2½"
P, R	(4) 1½" x 2" - green
Q	(2) 2" x 2" - navy
S	(1) 2½" x 2½"
T	(4) 1½" x 2" - green

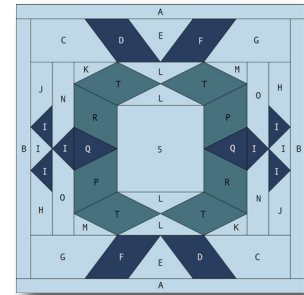

Hobbystash Colorway

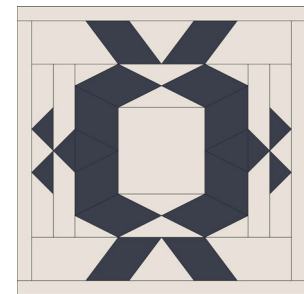

Jane Stickle Colorway

*\*The actual required width for Unit A and Unit B units is ¾". The increased width specified above allows for squaring the block to exactly 5½".*

### Assembly:

- Using templates on Page L10-2 and L10-3, foundation piece sections. Arrange and sew together.
- Join Unit B to the right side of the block, and then the left.
- Join Unit A to the top of the block and then the bottom. Square up block to measure 5½" x 5½" square.

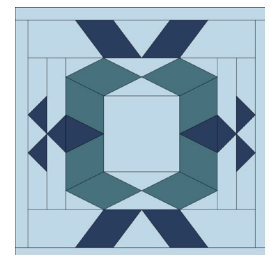
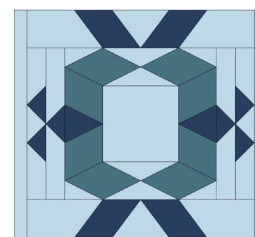
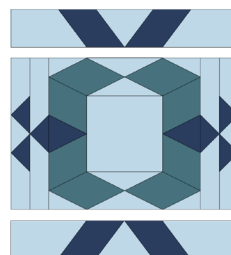
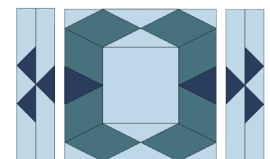
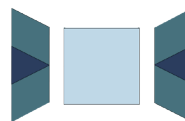

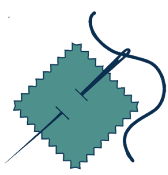

SET PRINTER TO "ACTUAL SIZE" WHEN PRINTING THIS PAGE.

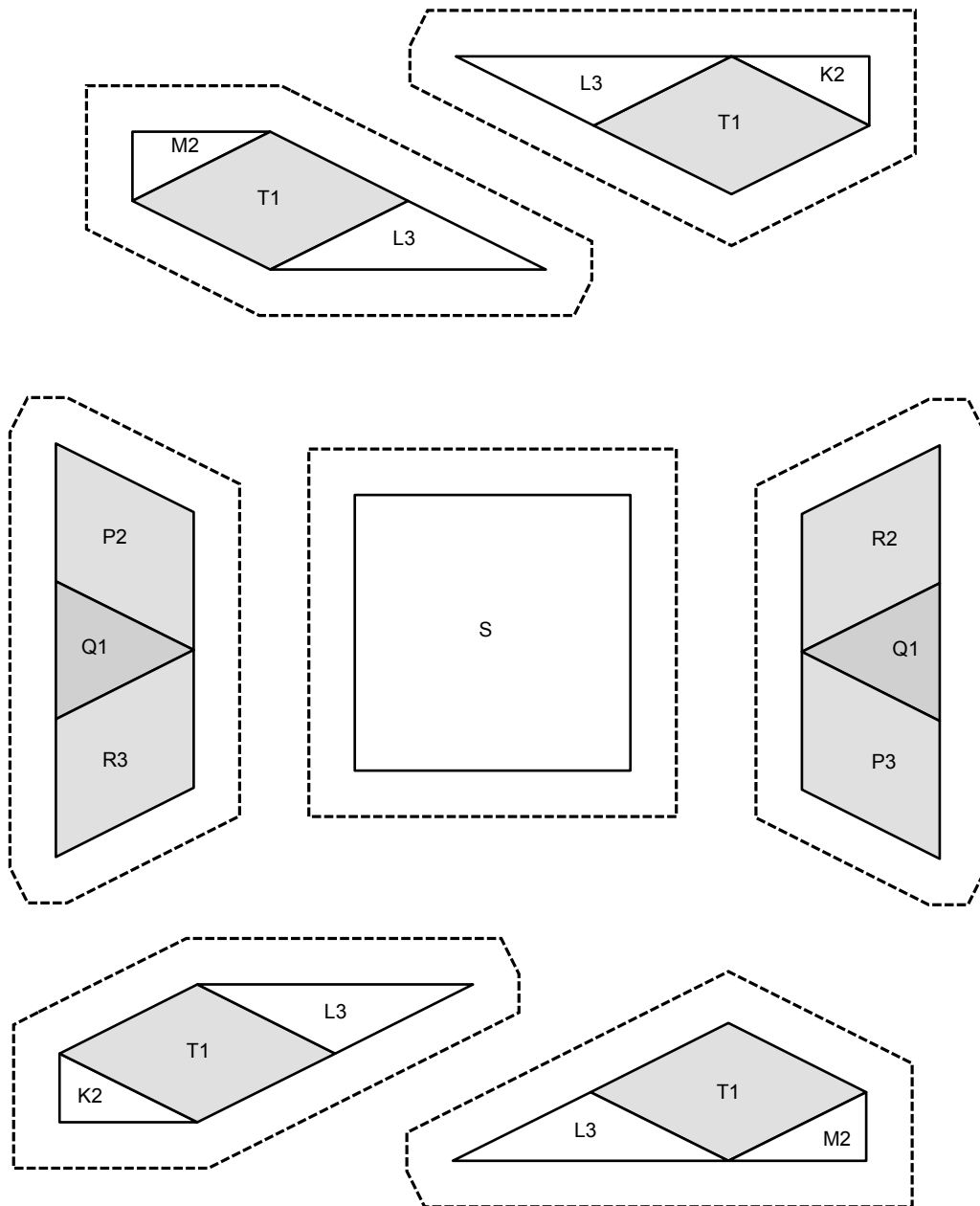

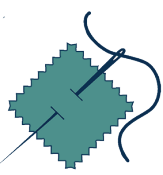

SET PRINTER TO "ACTUAL SIZE" WHEN PRINTING THIS PAGE.

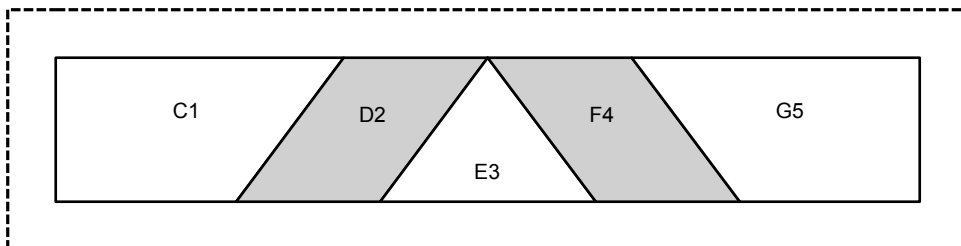
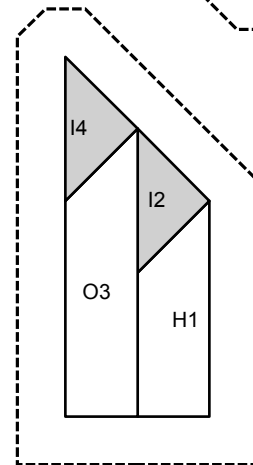
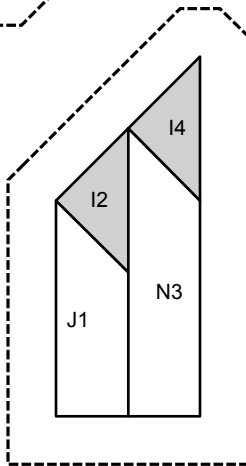
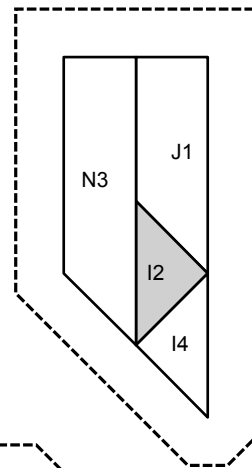
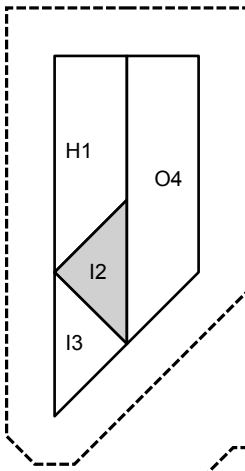
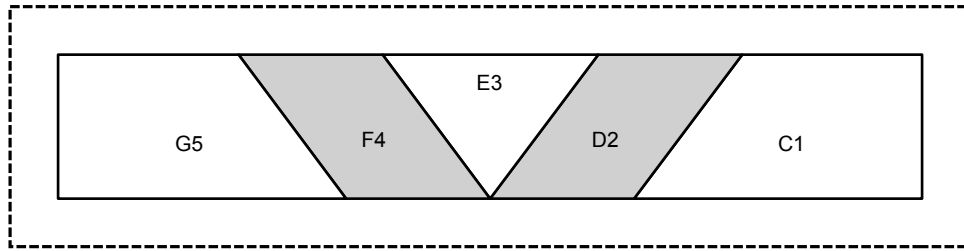

2"



SET PRINTER TO "ACTUAL SIZE" WHEN PRINTING THIS PAGE.

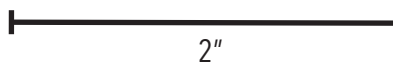
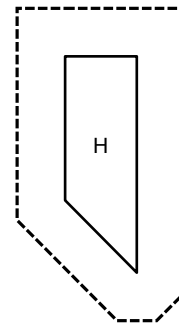
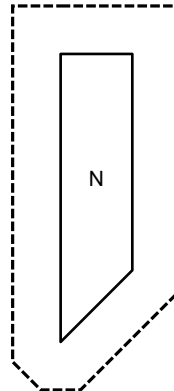
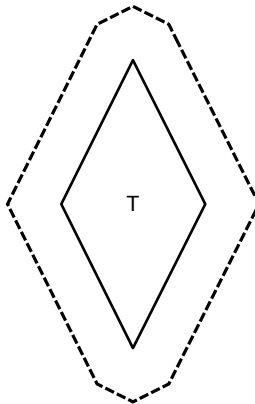
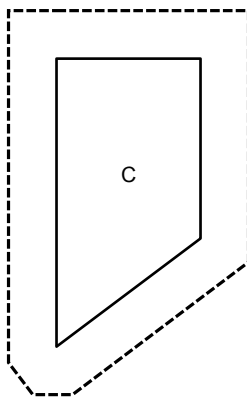
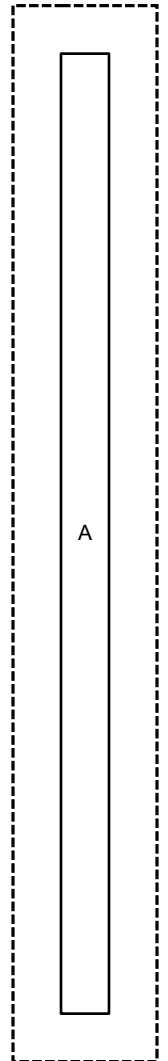
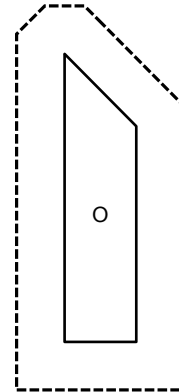
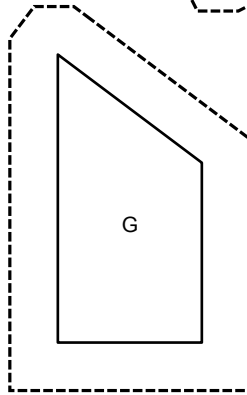
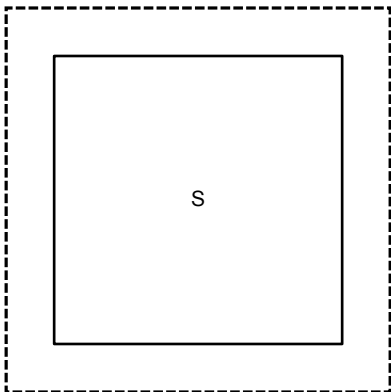
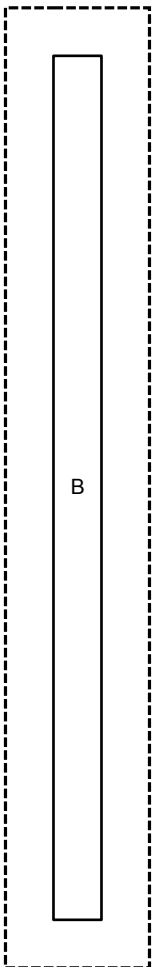
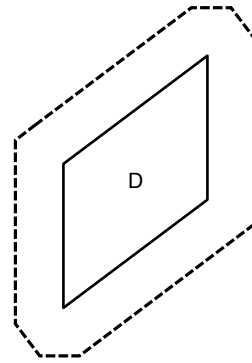
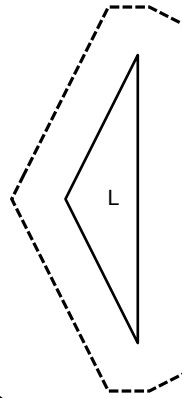
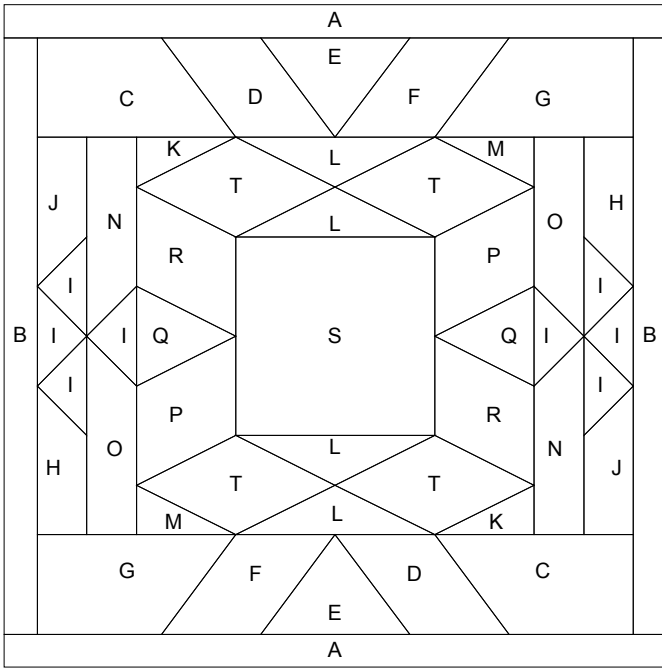

2"

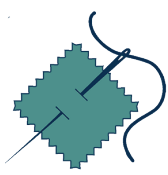

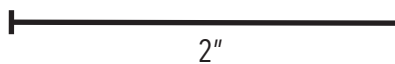
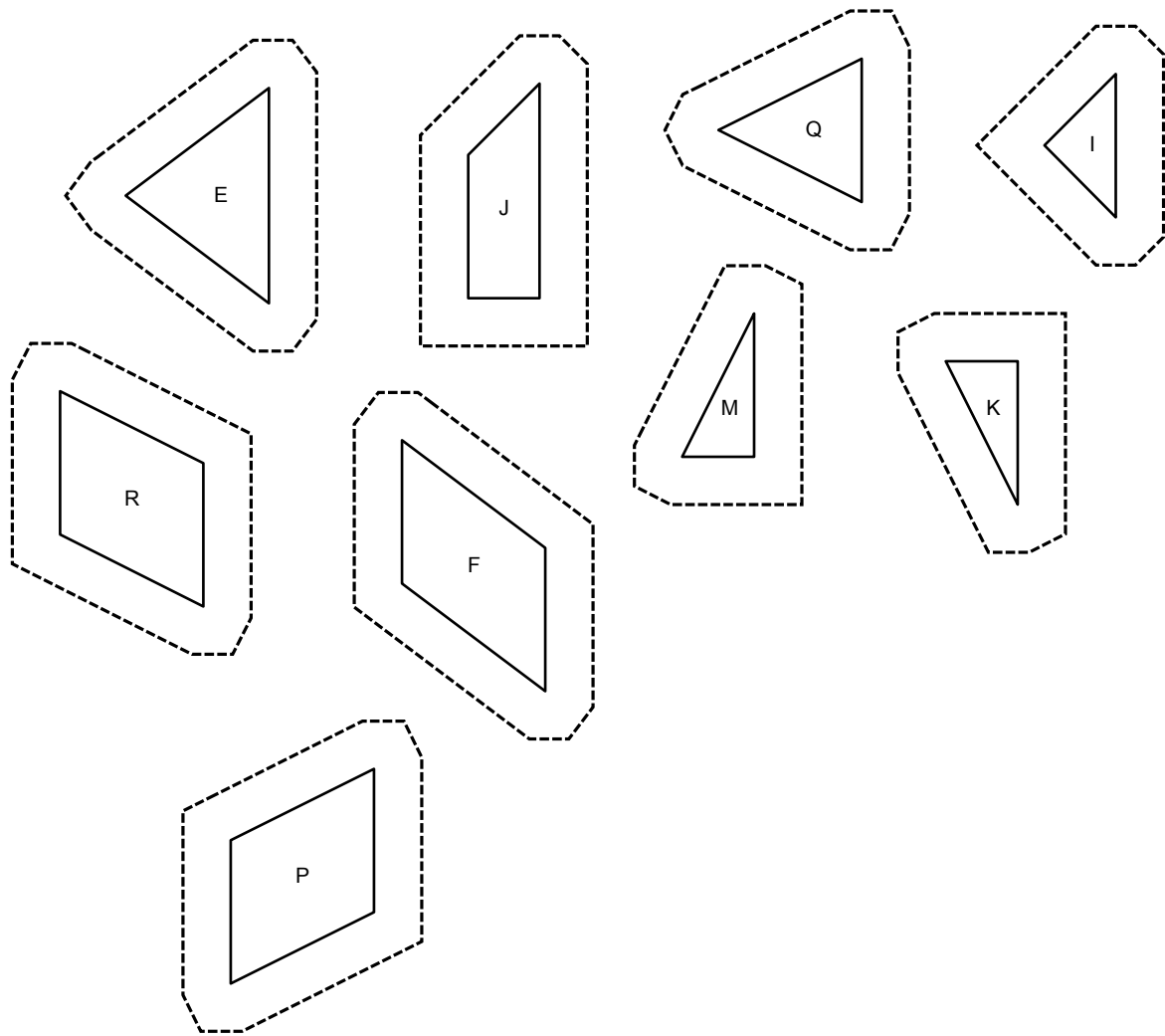

SET PRINTER TO "ACTUAL SIZE" WHEN PRINTING THIS PAGE.

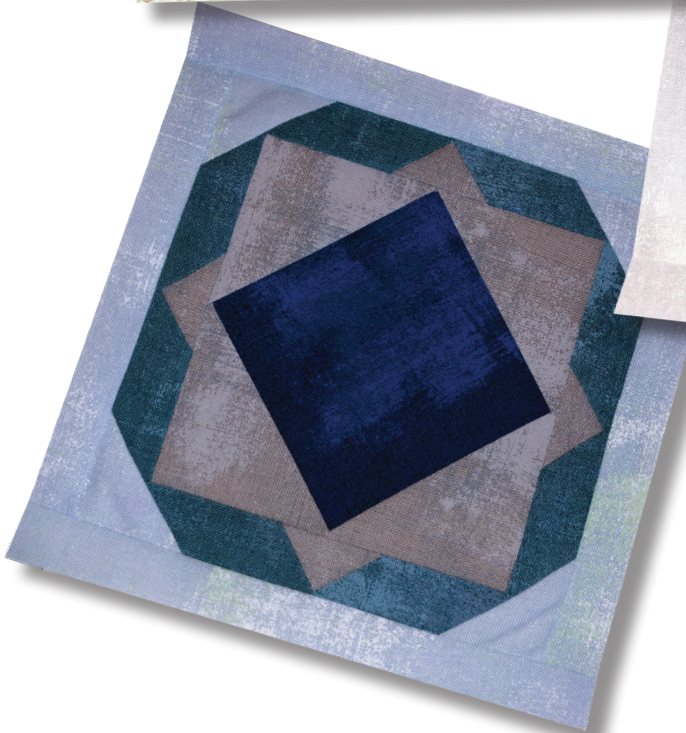

## The Jane Stickle Quilt - Block L11



### What you need:

Patches	Quantity/size
A*	(2) 1" x 6"
B*	(2) 1" x 5"
C	 (2) 2½" x 2½" - cut once diagonally
D	(4) 1½" x 3½"
E	(4) 1½" x 3½"
F	 (1) 3" x 3" - cut twice diagonally
G	 (2) 3" x 3" - cut once diagonally
H	(1) 3½" x 3½"

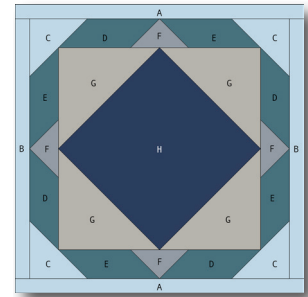

*Hobbystash Colorway*

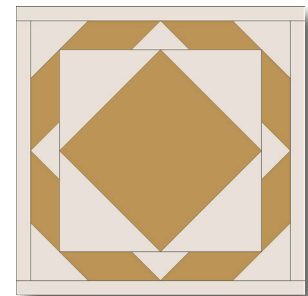

*Jane Stickle Colorway*

*\*The actual required width for Unit A and Unit B units is ¾". The increased width specified above allows for squaring the block to exactly 5½".*

### Assembly:

1. Using templates on Page L11-2, foundation piece sections. Arrange and sew together.
2. Join Unit B to the right side of the block, and then the left.
3. Join Unit A to the top of the block and then the bottom. Square up block to measure 5½" x 5½" square.

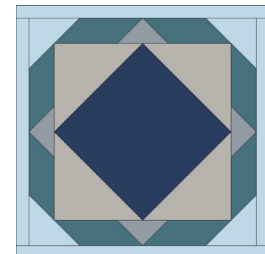
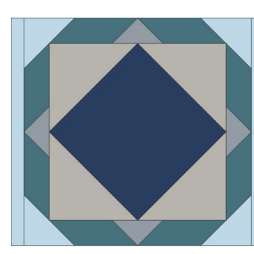
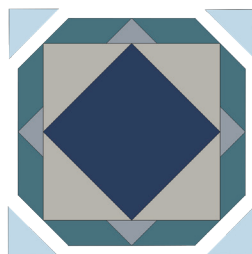
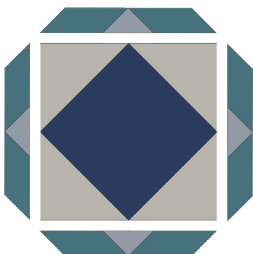

SET PRINTER TO "ACTUAL SIZE" WHEN PRINTING THIS PAGE.

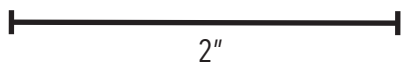
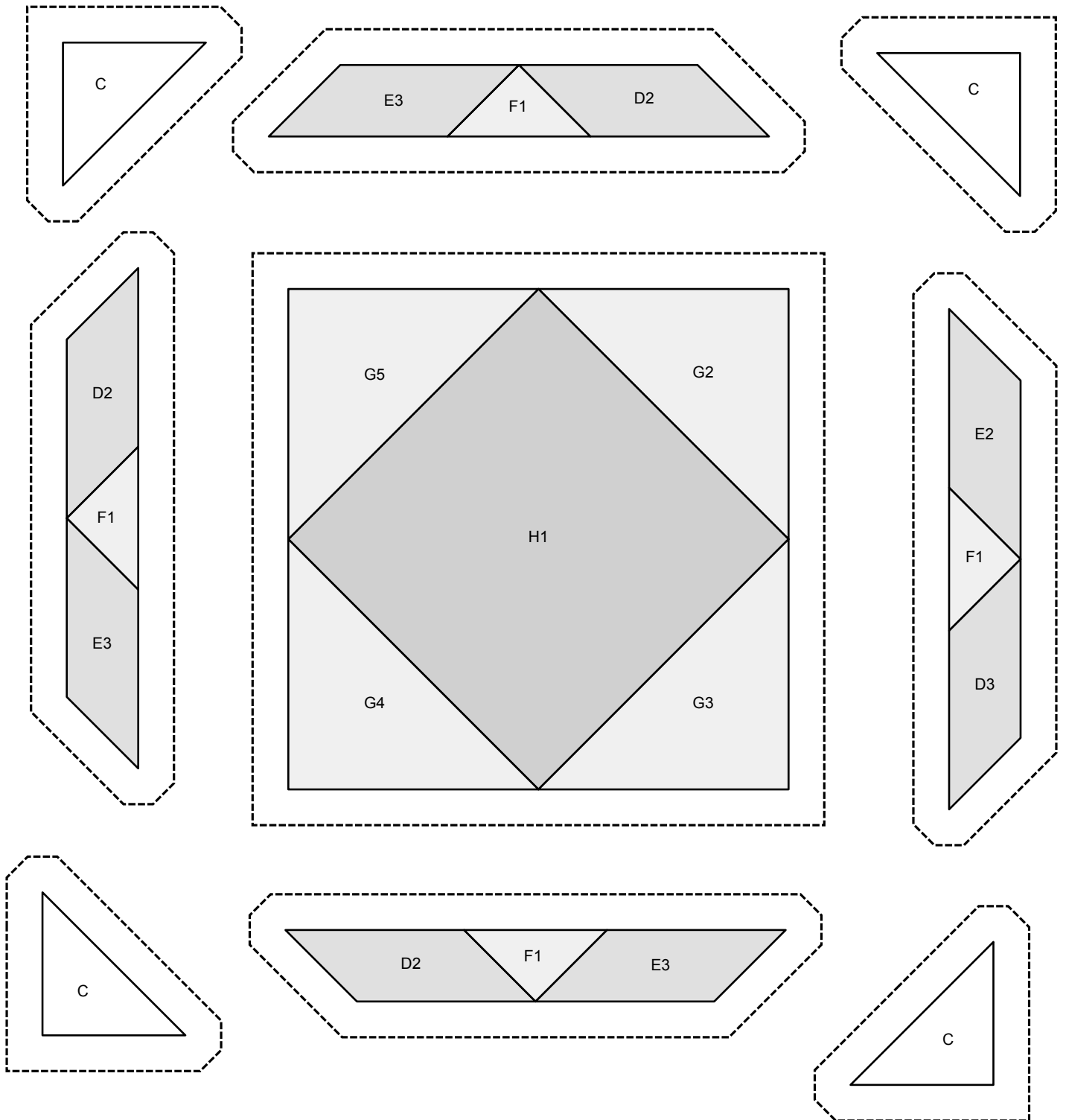



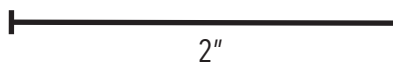
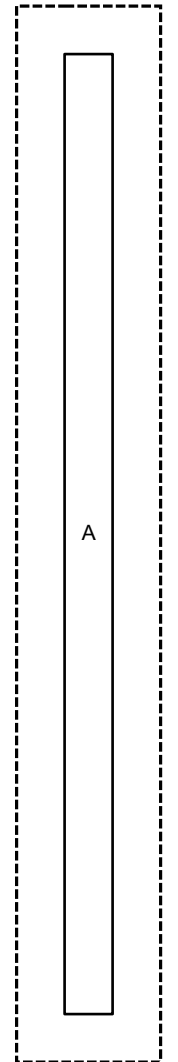
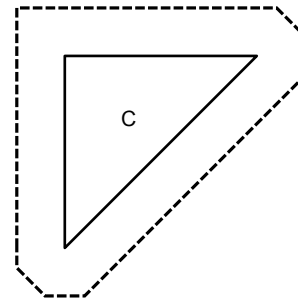
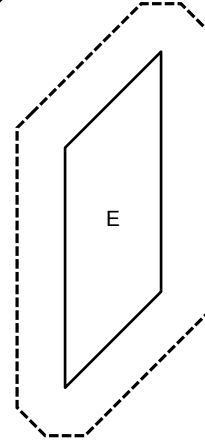
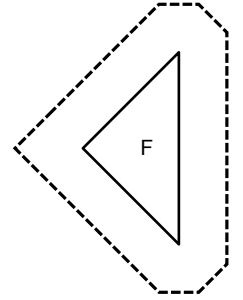
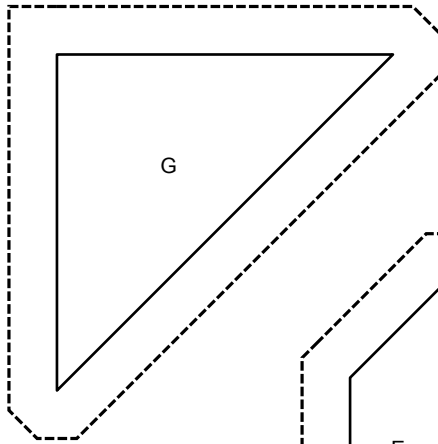
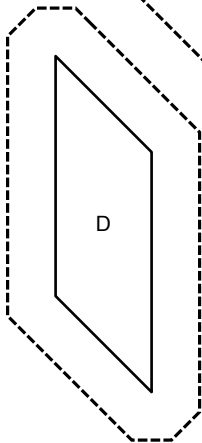
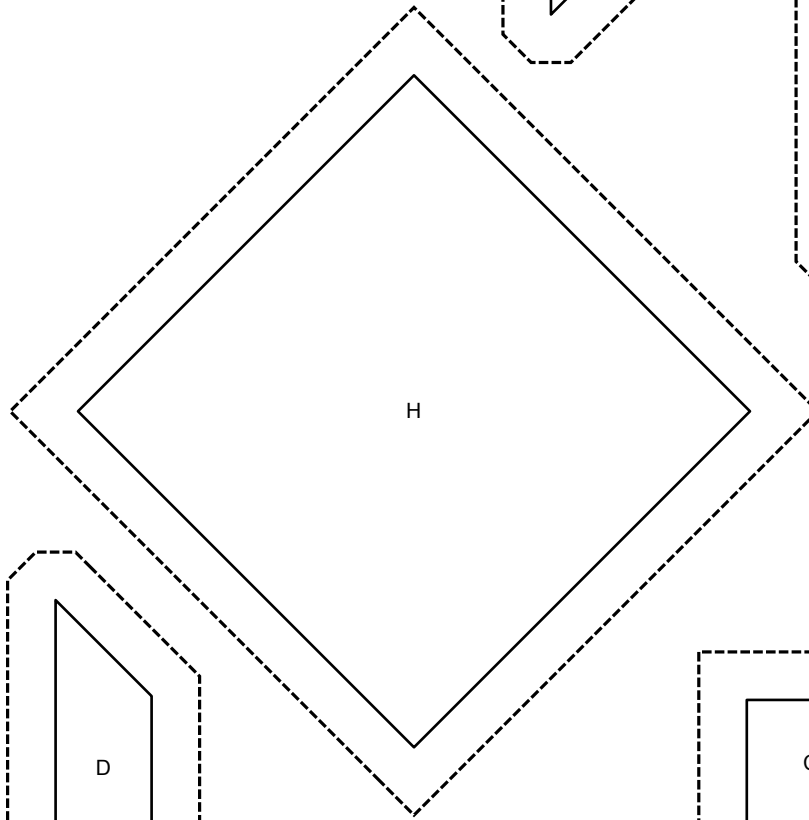
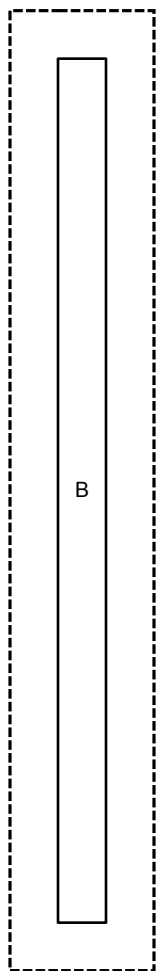
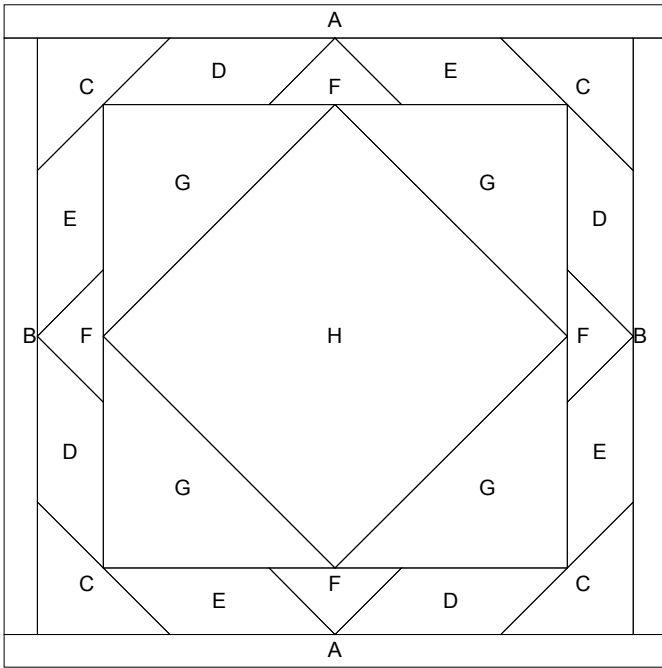

SET PRINTER TO "ACTUAL SIZE" WHEN PRINTING THIS PAGE.

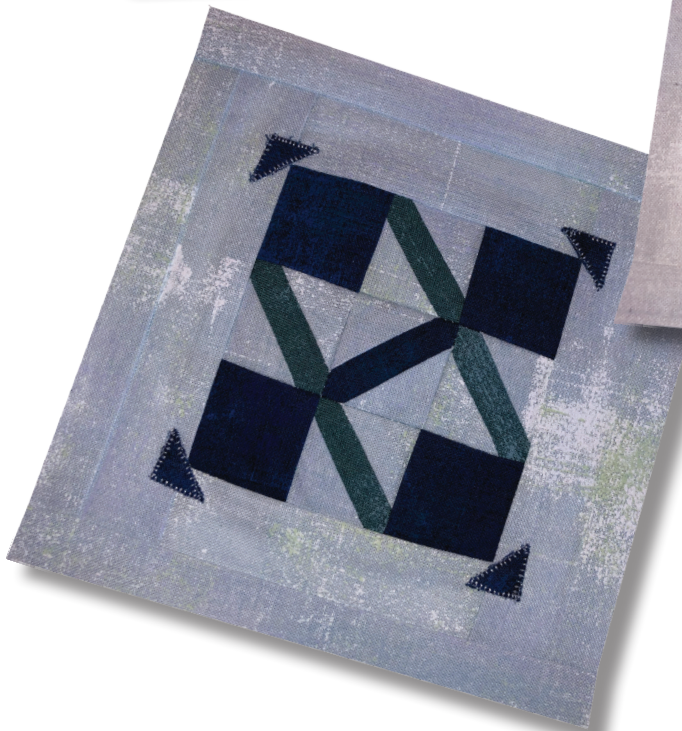

## The Jane Stickle Quilt - Block L12



### What you need:

Patches	Quantity/size
A*	(2) 1" x 6"
B*	(2) 1" x 5"
C	(2) 1½" x 5½"
D	(2) 1½" x 4"
E	(4) 2" x 2"
F	 (5) 2" x 2" - cut once diagonally
G	(4) 1½" x 3" - green (1) 1½" x 3" - navy
H	 (2) 2" x 2" - cut once diagonally

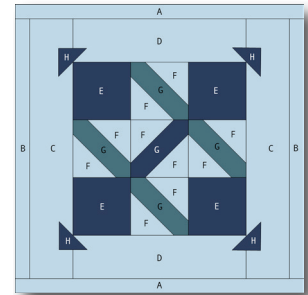

Hobbystash Colorway

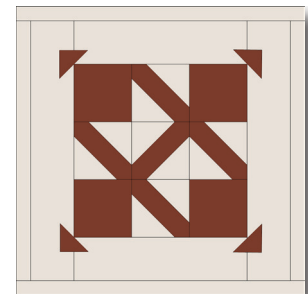

Jane Stickle Colorway

### Assembly:

- Using templates on Page L12-2, foundation piece sections. Arrange and sew together.
- Join Unit B to the right side of the block, and then the left.
- Join Unit A to the top of the block and then the bottom. Square up block to measure 5½" x 5½" square.

*\*The actual required width for Unit A and Unit B units is ¾". The increased width specified above allows for squaring the block to exactly 5½".*

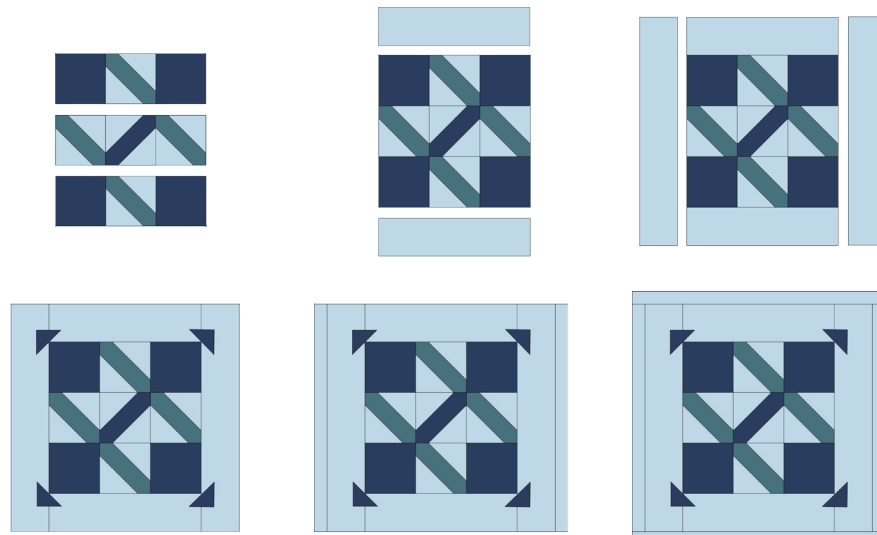

SET PRINTER TO "ACTUAL SIZE" WHEN PRINTING THIS PAGE.

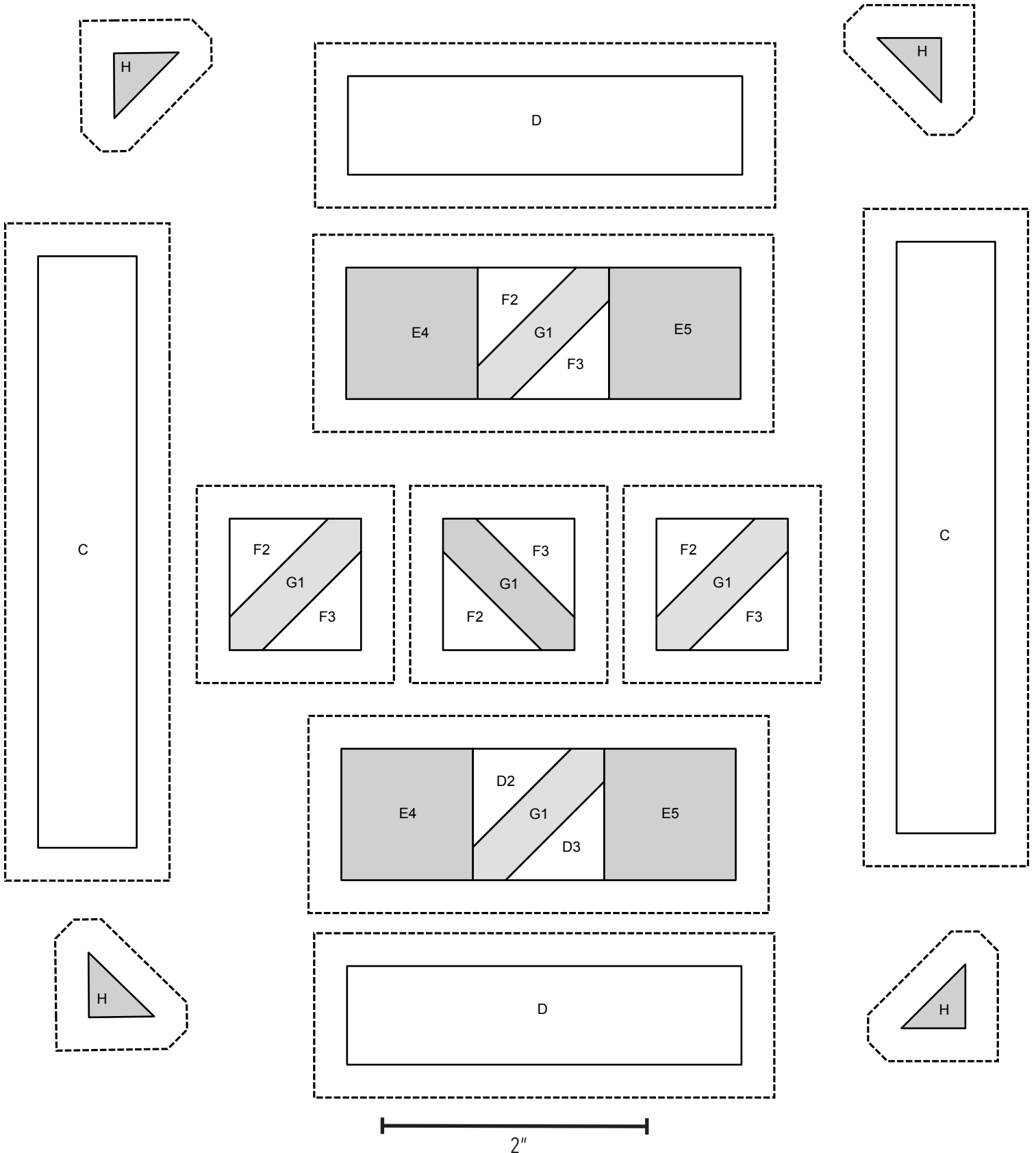

SET PRINTER TO "ACTUAL SIZE" WHEN PRINTING THIS PAGE.

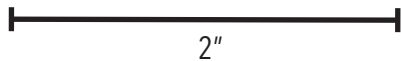
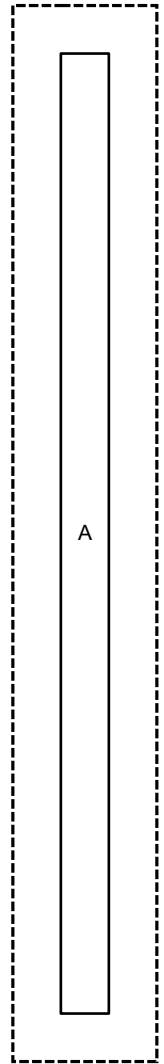
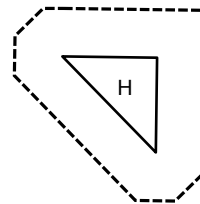
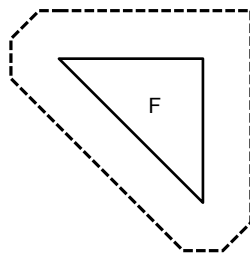
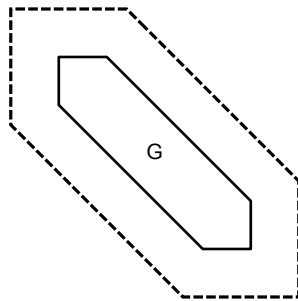
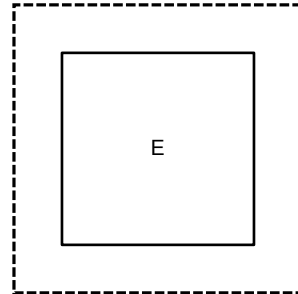
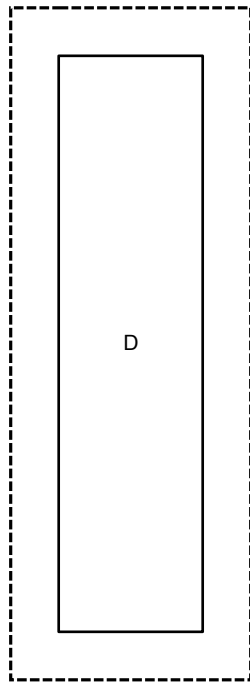
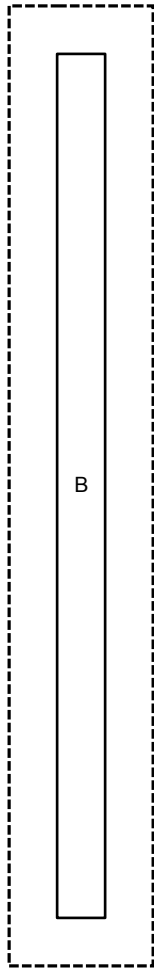
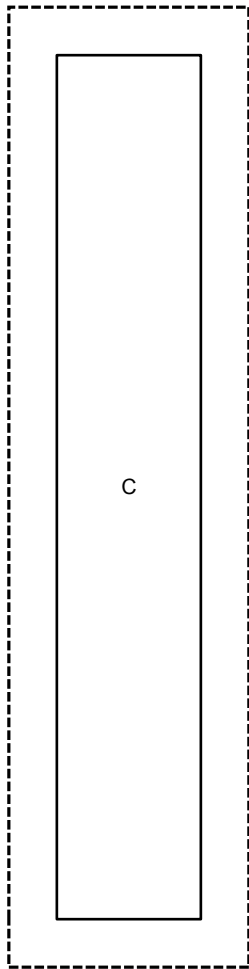
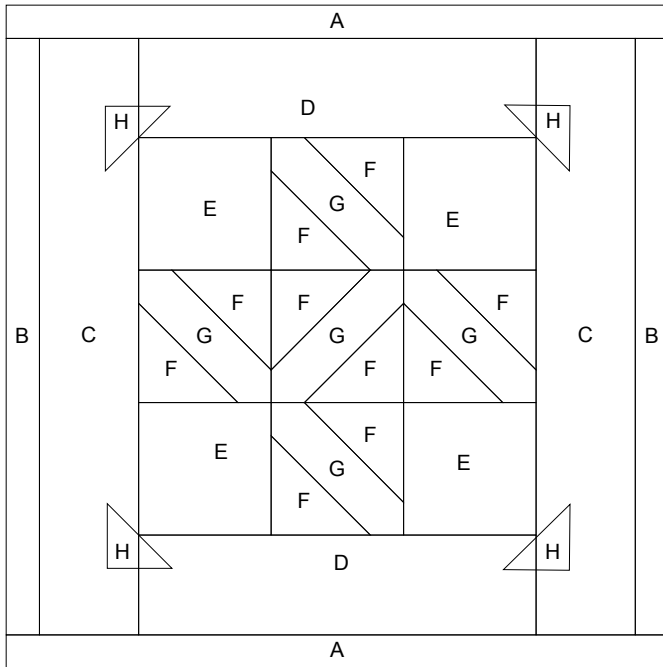



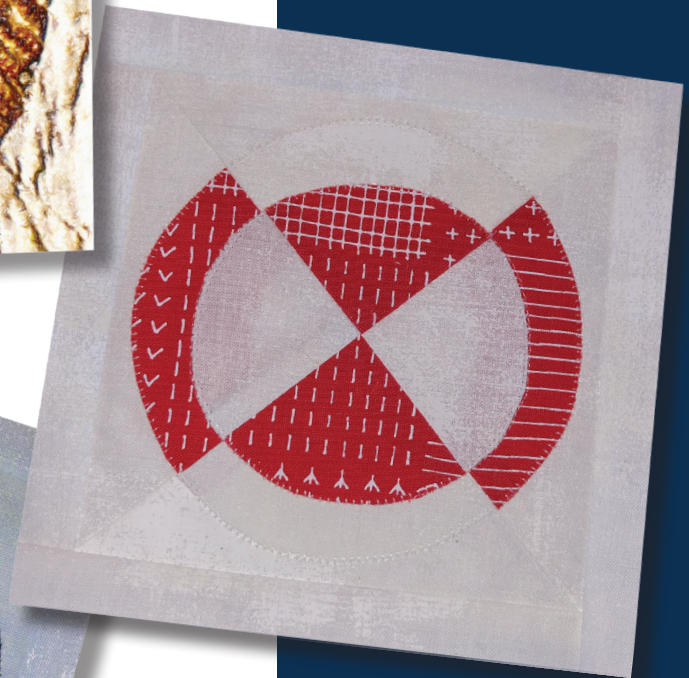

## The Jane Stickle Quilt - Block L13

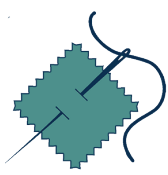



### What you need:

Patches	Quantity/size
A*	(2) 1" x 6"
B*	(2) 1" x 5"
C	 (1) 6" x 6" - cut twice diagonally - light blue
D	 (1) 6" x 6" - cut twice diagonally - navy
E	 (1) 6" x 6" - cut twice diagonally - green

*\*The actual required width for Unit A and Unit B units is ¾". The increased width specified above allows for squaring the block to exactly 5½".*

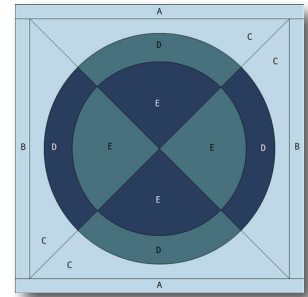

*Hobbystash Colorway*

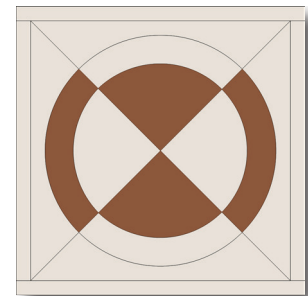

*Jane Stickle Colorway*

### Assembly:

1. Assemble and sew together two Unit D and two Unit E to make one quarter-square triangle (QST) block. Repeat to make a second block.
2. Using Unit D circle template on Page L13-2 , cut circle from one Step 1 QST block.
3. Assemble and sew together four Unit C to make a one QST block.
4. Appliqué Step 2 circle to Step 3 QST block, matching seams.
5. Using Unit E circle template on Page L13-s, cut circle from second Step 1 QST block.
6. Appliqué Step 5 circle to Step 4 QST block, matching seams and color pattern. Square block to 5" x 5".
7. Join Unit B to the right side of the block, and then the left.
8. Join Unit A to the top of the block and then the bottom. Square up block to measure 5½" x 5½" square.

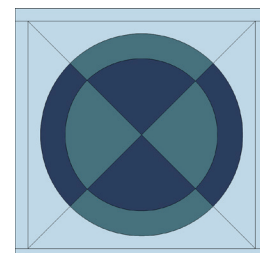
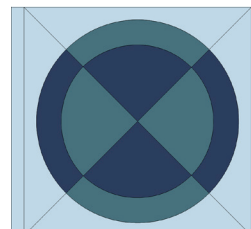
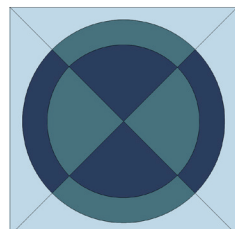
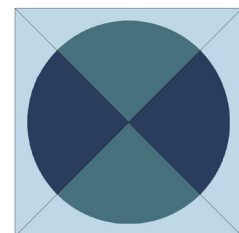
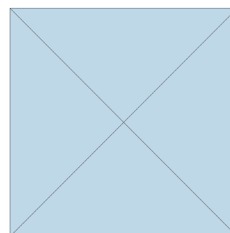
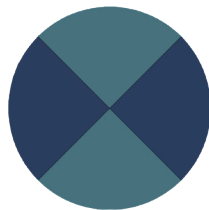

SET PRINTER TO "ACTUAL SIZE" WHEN PRINTING THIS PAGE.

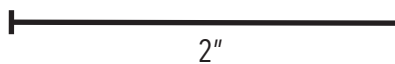
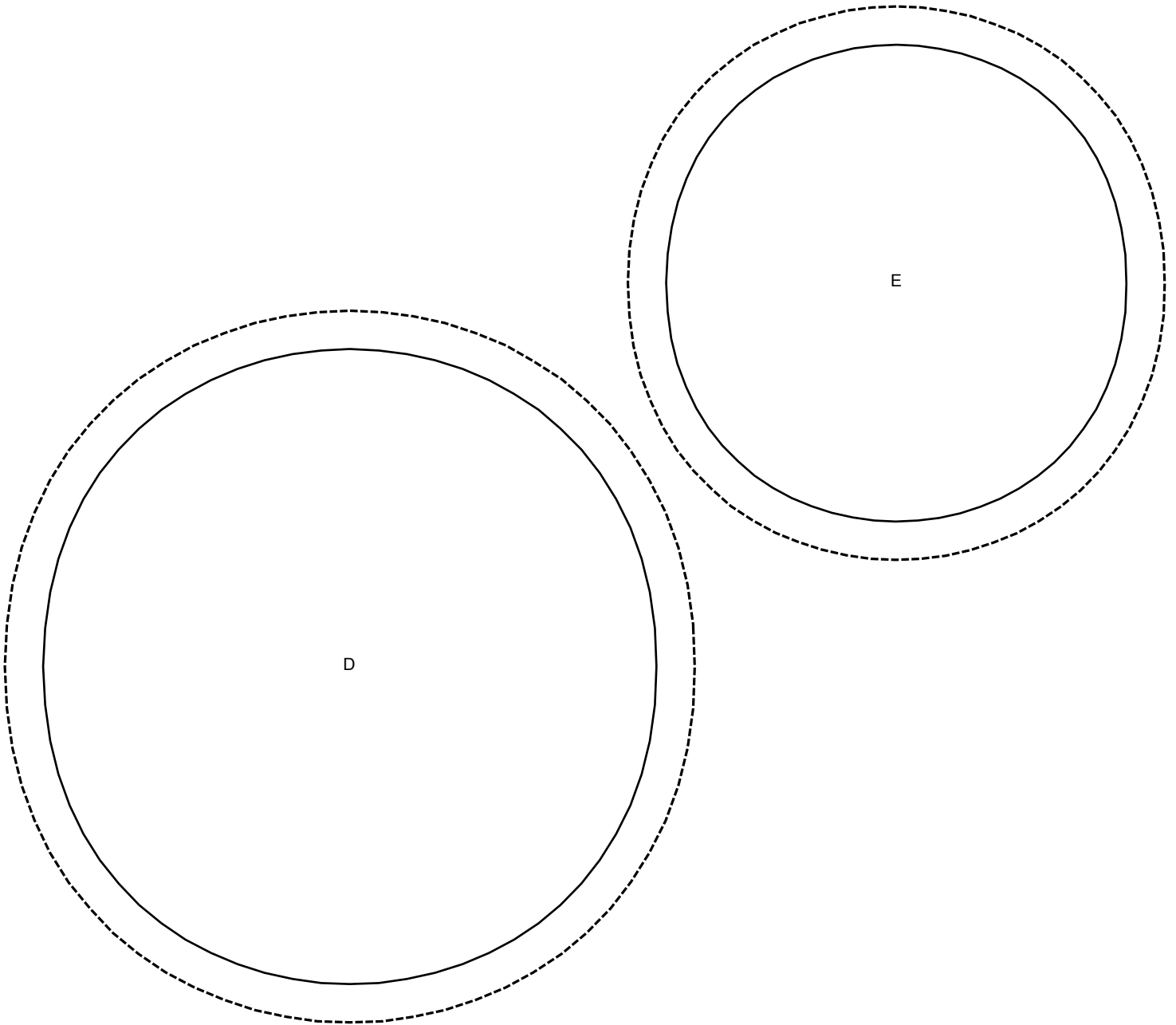

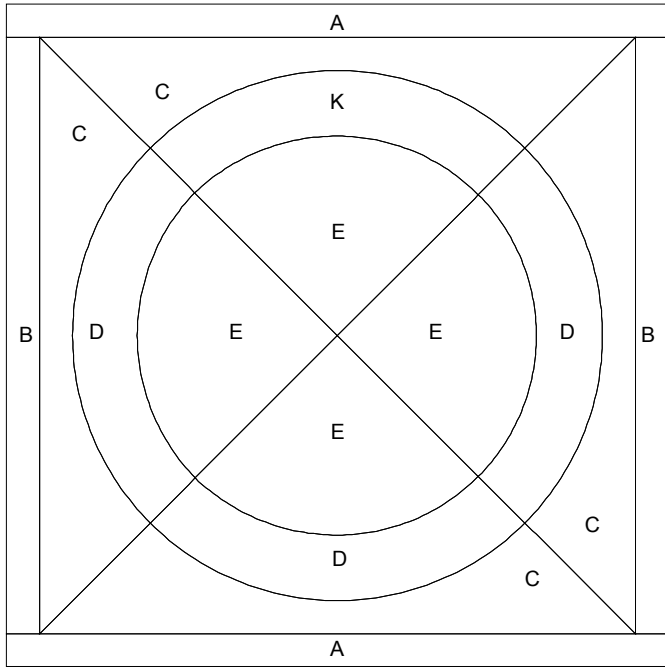

SET PRINTER TO "ACTUAL SIZE" WHEN PRINTING THIS PAGE.

