

The Jane Stickle Quilt - Row H

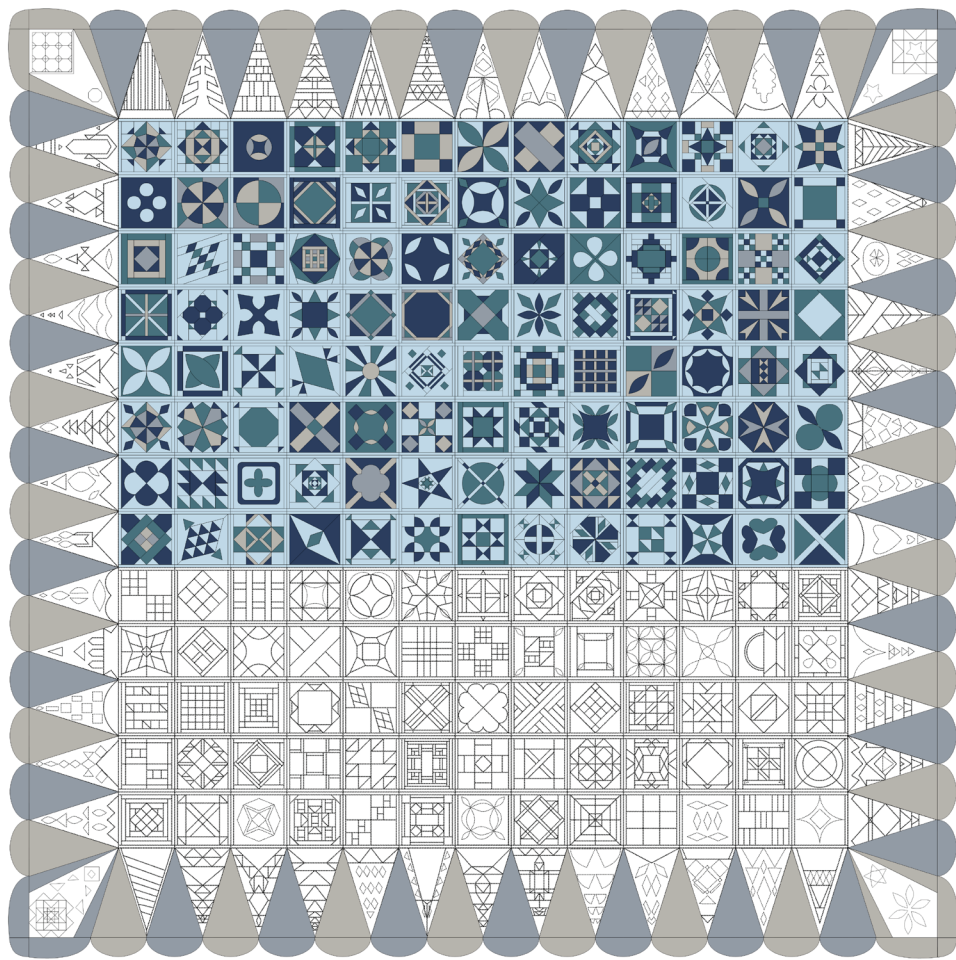

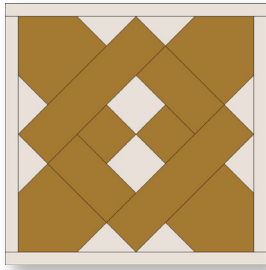

H1

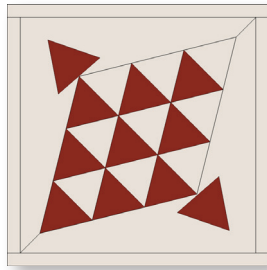

H2

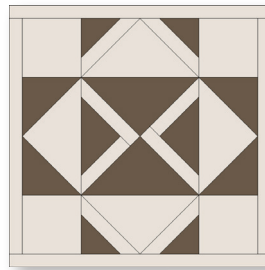

H3

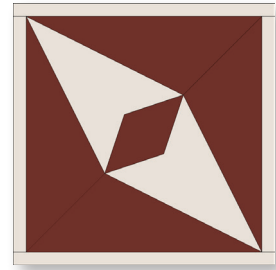

H4

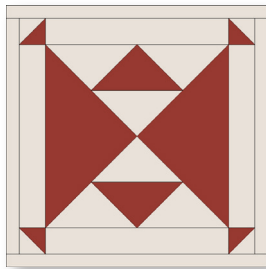

H5

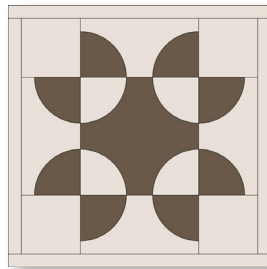

H6

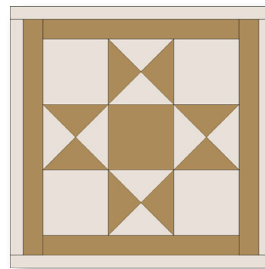

H7

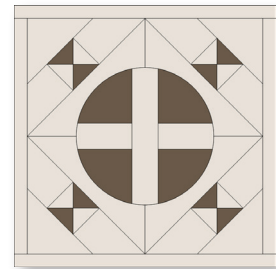

H8

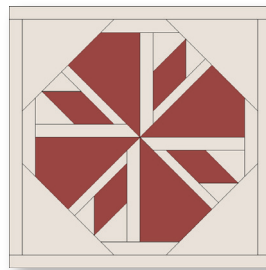

H9

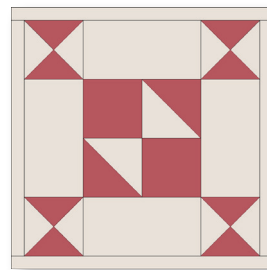

H10

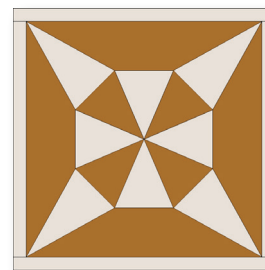

H11

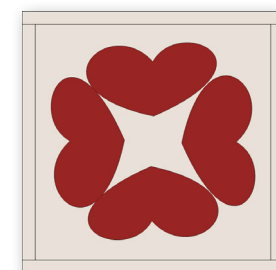

H12

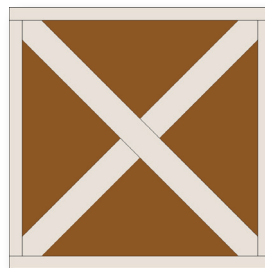

H13

The Jane Stickle Quilt - Block H1

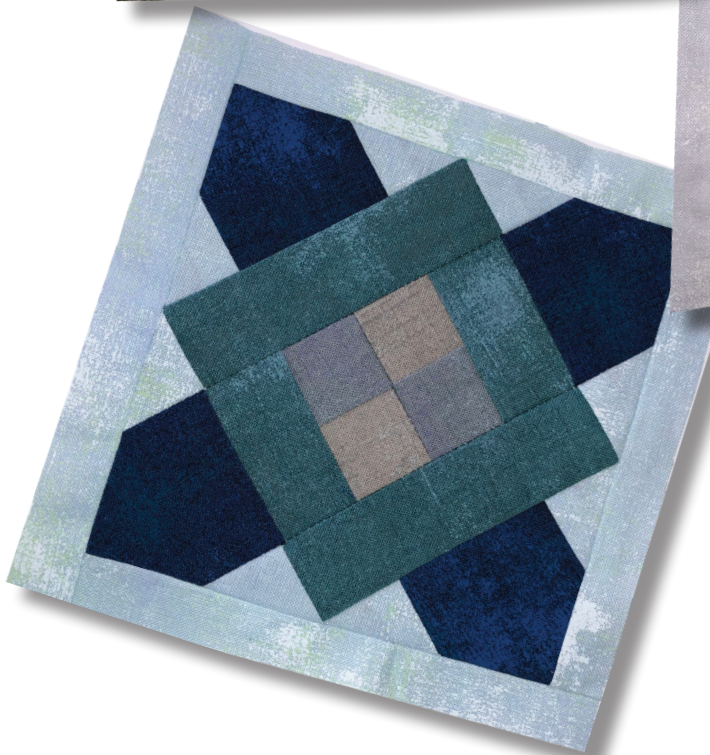

What you need:

Patches	Quantity/size
A*	(2) 1" x 6"
B*	(2) 1" x 5"
C	(4) 3" x 3"
D	 (2) 3" x 3", cut twice diagonally
E	(2) 1½" x 3"
F	(2) 1½" x 1½" - gray (2) 1½" x 1½" - beige
G	(2) 1½" x 4"

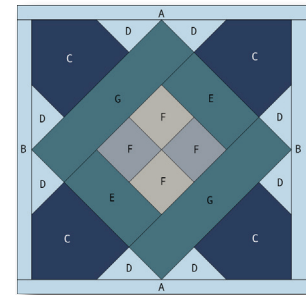

Hobbystash Colorway

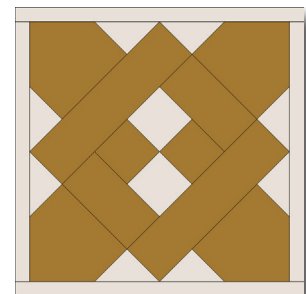

Jane Stickle Colorway

**The actual required width for Unit A and Unit B units is ¾". The increased width specified above allows for squaring the block to exactly 5½".*

Assembly:

1. Using templates on Page H1-2, foundation piece sections.
2. Assemble sections and sew together.
3. Join Unit B to the right side of the block, and then the left.
4. Join Unit A to the top of the block and then the bottom. Square up block to measure 5½" x 5½" square.

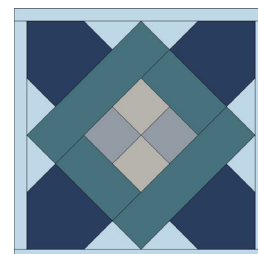
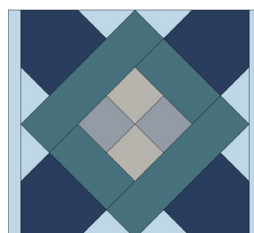

SET PRINTER TO "ACTUAL SIZE" WHEN PRINTING THIS PAGE.

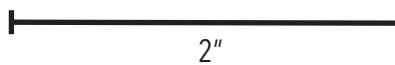
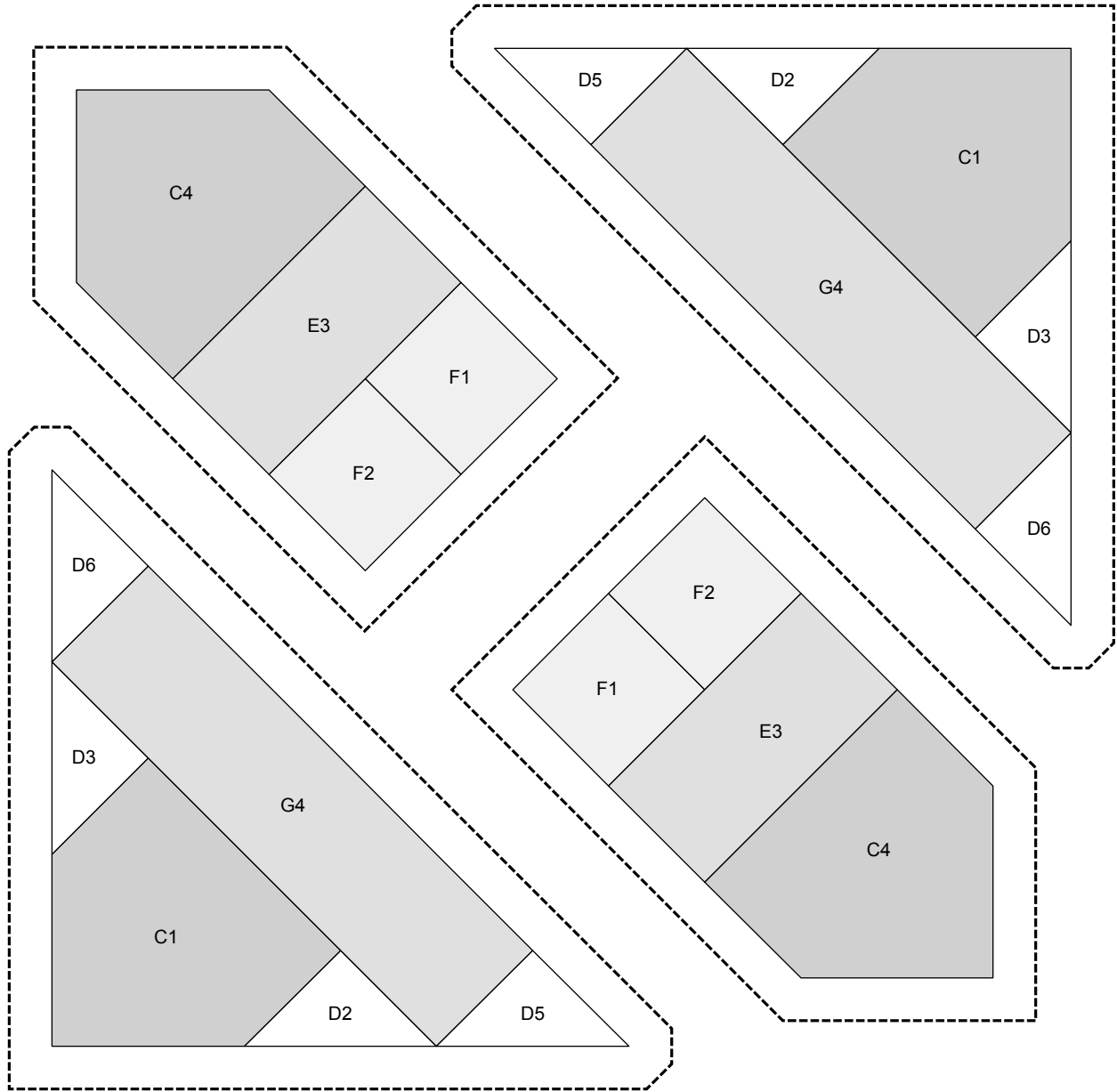

SET PRINTER TO "ACTUAL SIZE" WHEN PRINTING THIS PAGE.

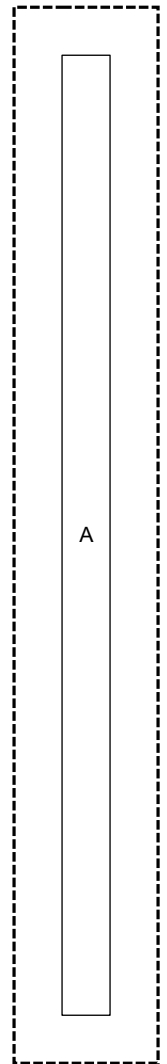
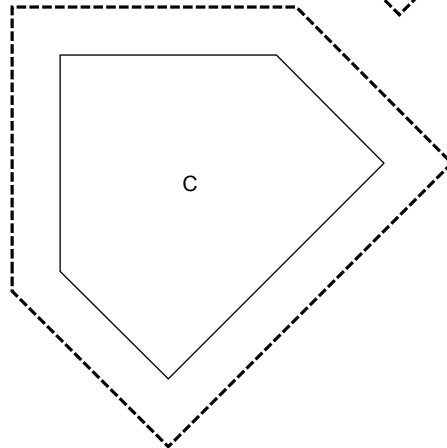
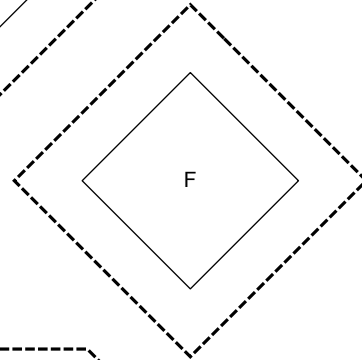
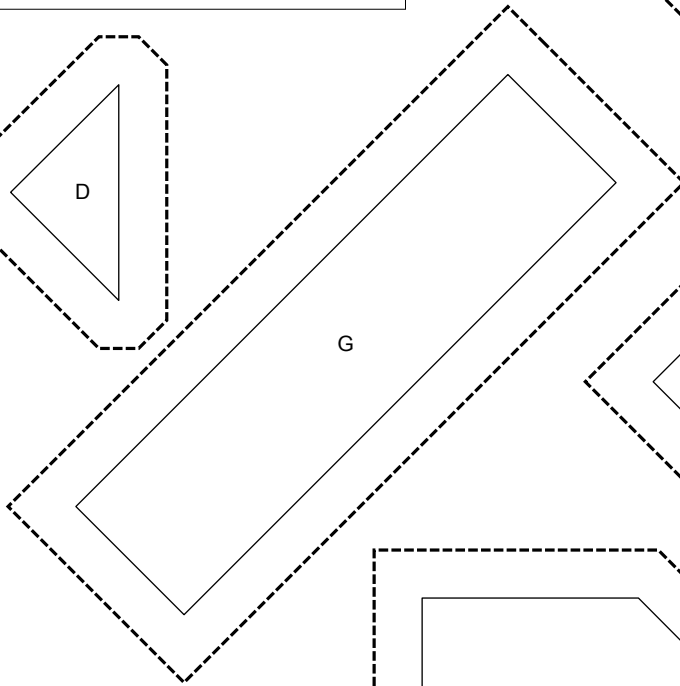
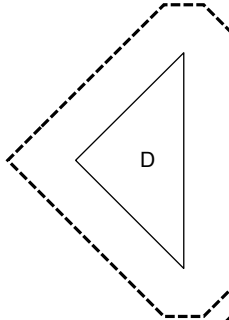
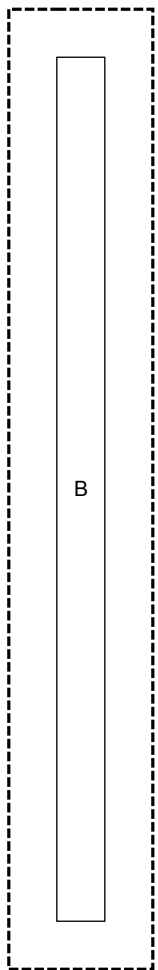
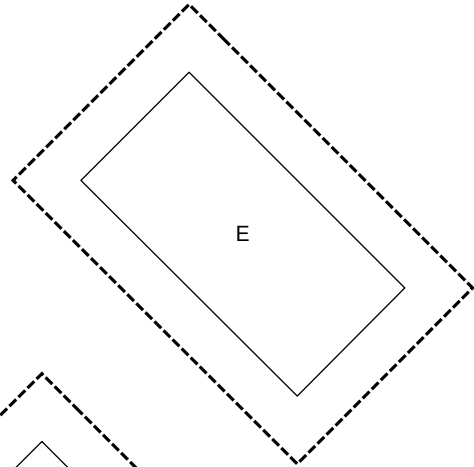
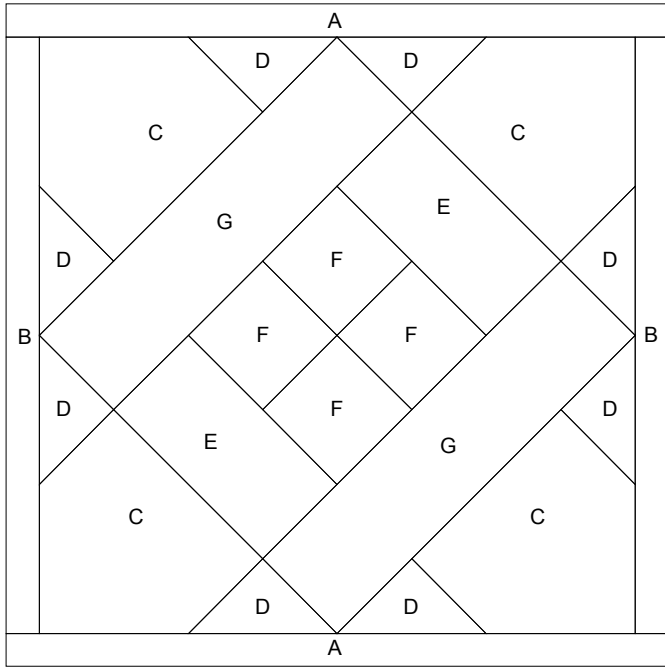

2"

The Jane Stickle Quilt - Block H2

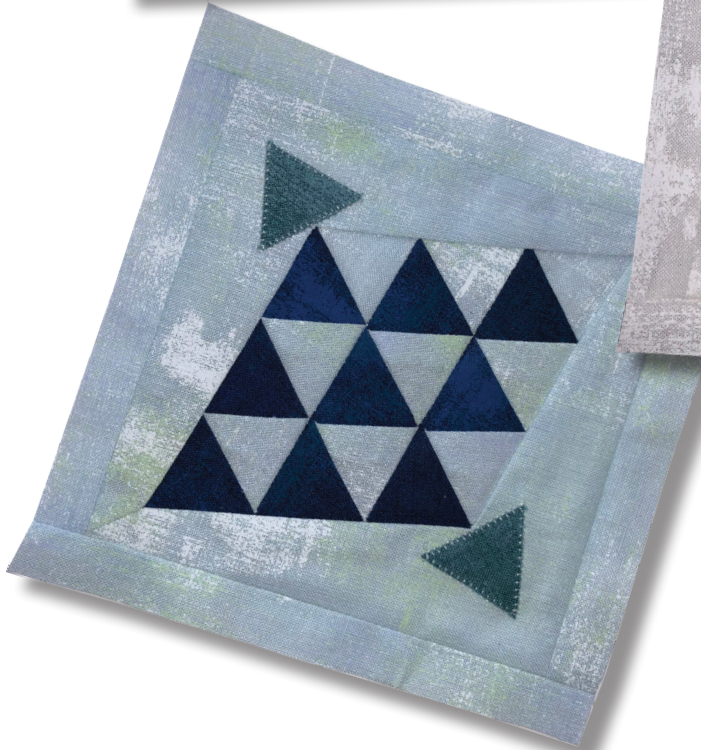

What you need:

Patches	Quantity/size
A*	(2) 1" x 6"
B*	(2) 1" x 5"
C	(1) 6" x 6", cut once diagonally
D	(9) 2½" x 2½" - light blue (9) 2½" x 2½" - navy (2) 2½" x 2½" - green

**The actual required width for Unit A and Unit B units is ¾". The increased width specified above allows for squaring the block to exactly 5½".*

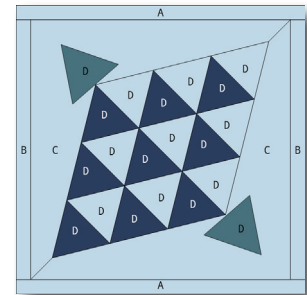

Hobbystash Colorway

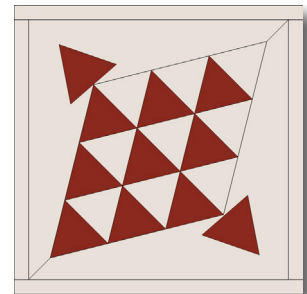

Jane Stickle Colorway

Assembly:

1. Using templates on Page H2-2, foundation piece sections. Assemble and sew together.
2. Appliqué remaining two green Unit D to opposite corners of Step 1 patch.
3. Join Unit B to the right side of the block, and then the left.
4. Join Unit A to the top of the block and then the bottom. Square up block to measure 5½" x 5½" square.

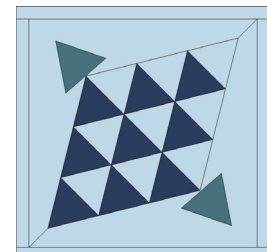
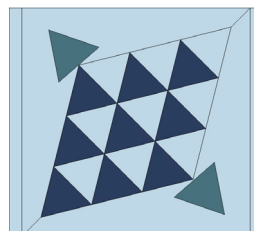
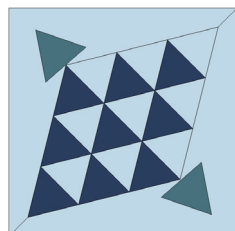
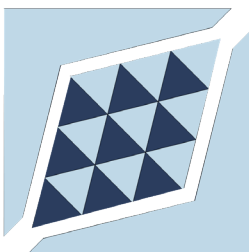

SET PRINTER TO "ACTUAL SIZE" WHEN PRINTING THIS PAGE.

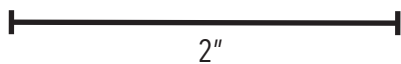
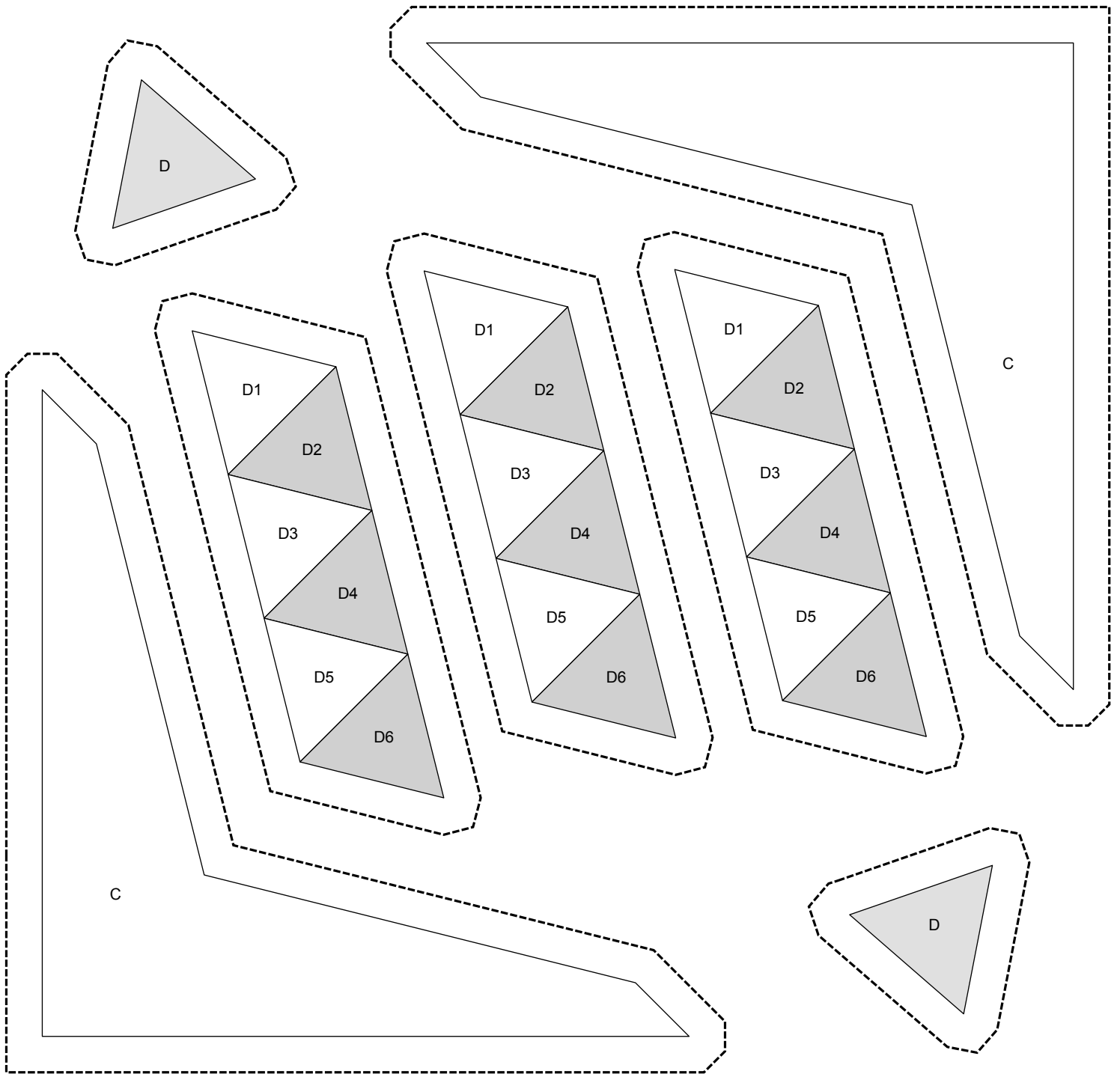

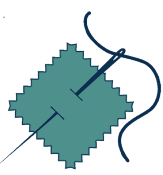

SET PRINTER TO "ACTUAL SIZE" WHEN PRINTING THIS PAGE.

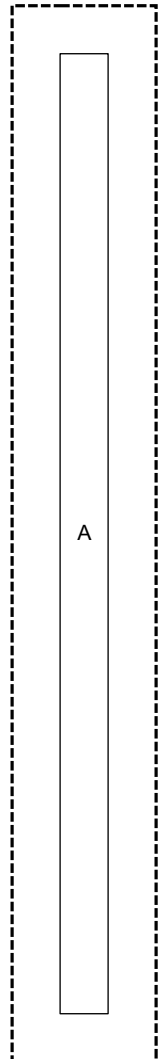
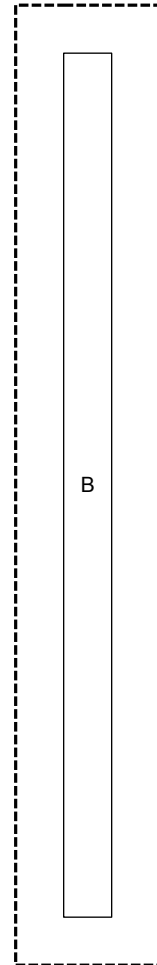
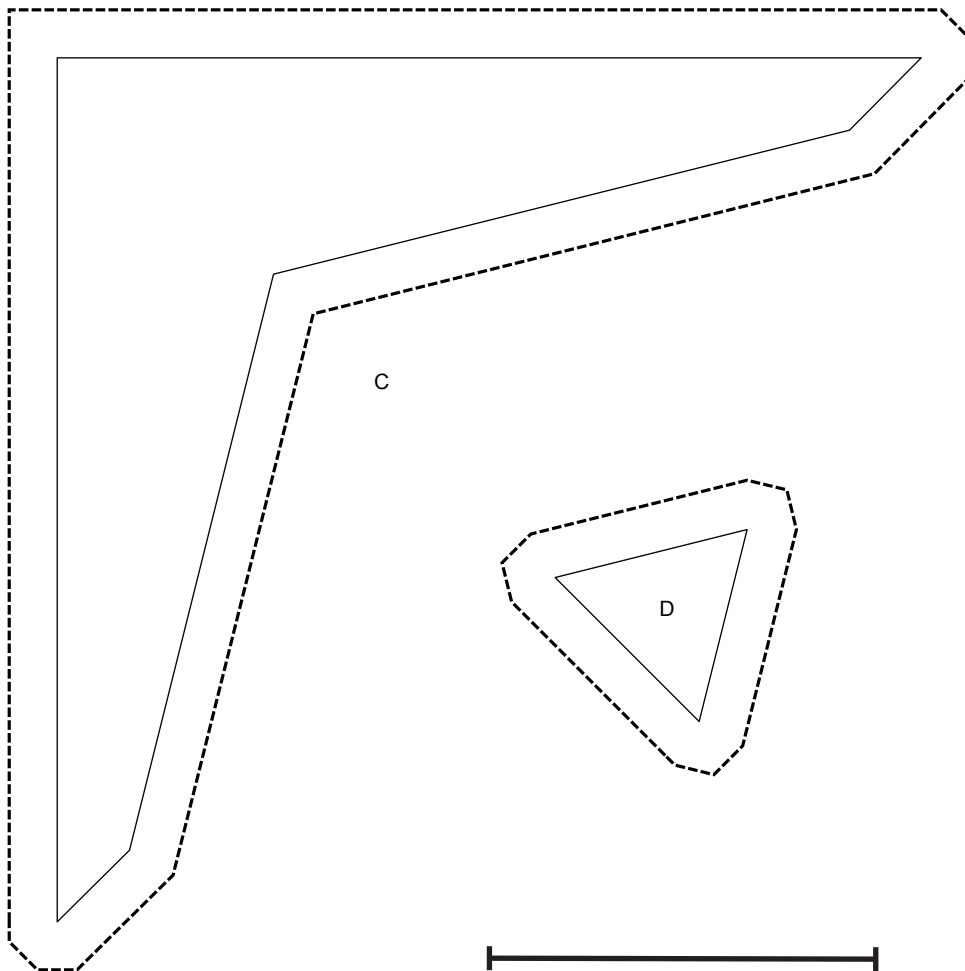
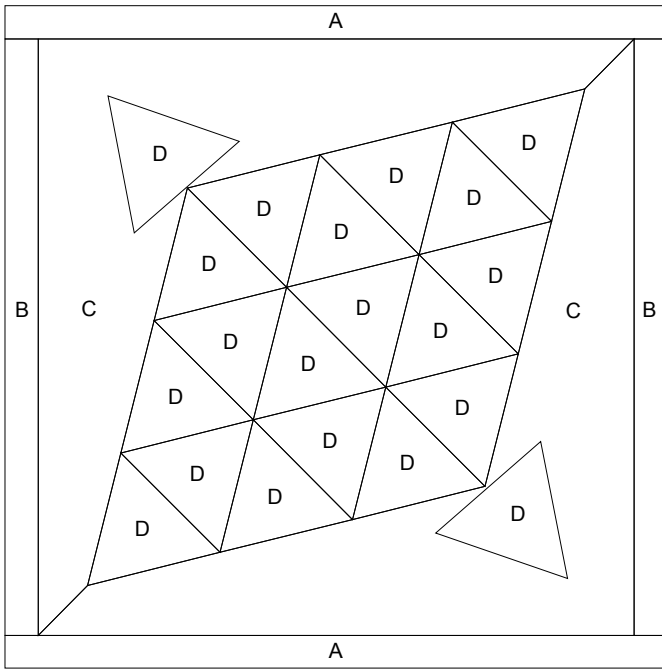

The Jane Stickle Quilt - Block H3



What you need:

Patches	Quantity/size
A*	(2) 1" x 6"
B*	(2) 1" x 5"
C	(4) 2" x 2"
D	(2) 2" x 2", cut once diagonally
E	(4) 1" x 3"
F	(2) 2½" x 2½", cut once diagonally
G	(1) 3½" x 3½" - lt blue, cut once diagonally (1) 3½" x 3½" - green, cut once diagonally (1) 3½" x 3½" - beige, cut once diagonally
H	(2) 1" x 2½"
I	(1) 2½" x 2½", cut once diagonally
J	(2) 1" x 2½"

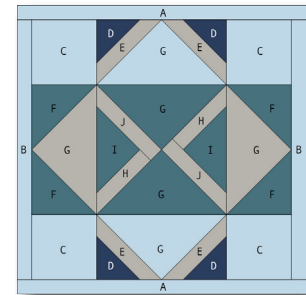

Hobbystash Colorway

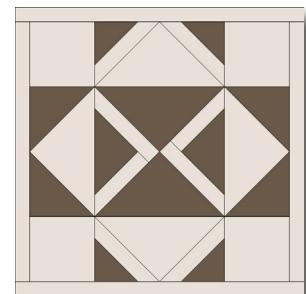

Jane Stickle Colorway

**The actual required width for Unit A and Unit B units is ¾". The increased width specified above allows for squaring the block to exactly 5½".*

Assembly:

- Using templates on Page H3-2, foundation piece sections.
- Assemble sections and sew together.
- Join Unit B to the right side of the block, and then the left.
- Join Unit A to the top of the block and then the bottom. Square up block to measure 5½" x 5½" square.

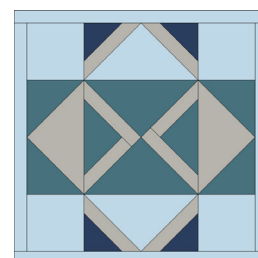
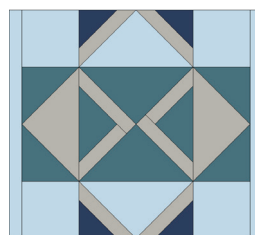
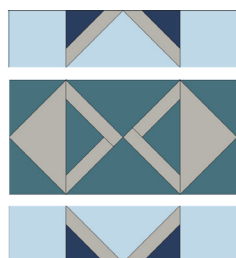

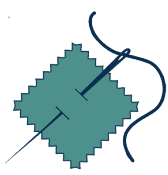

SET PRINTER TO "ACTUAL SIZE" WHEN PRINTING THIS PAGE.

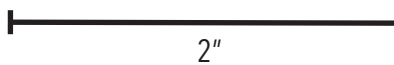
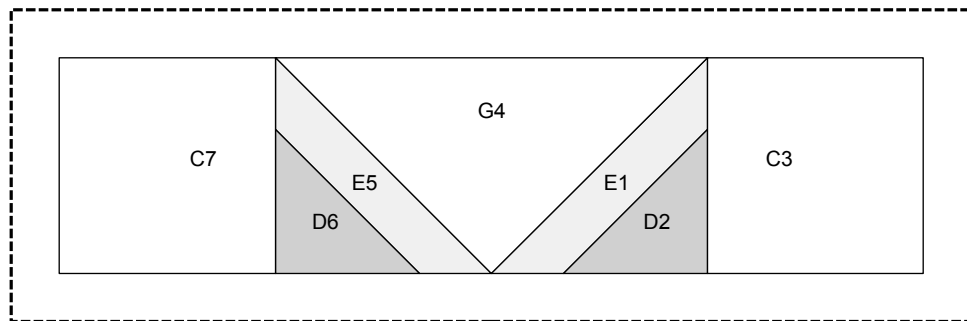
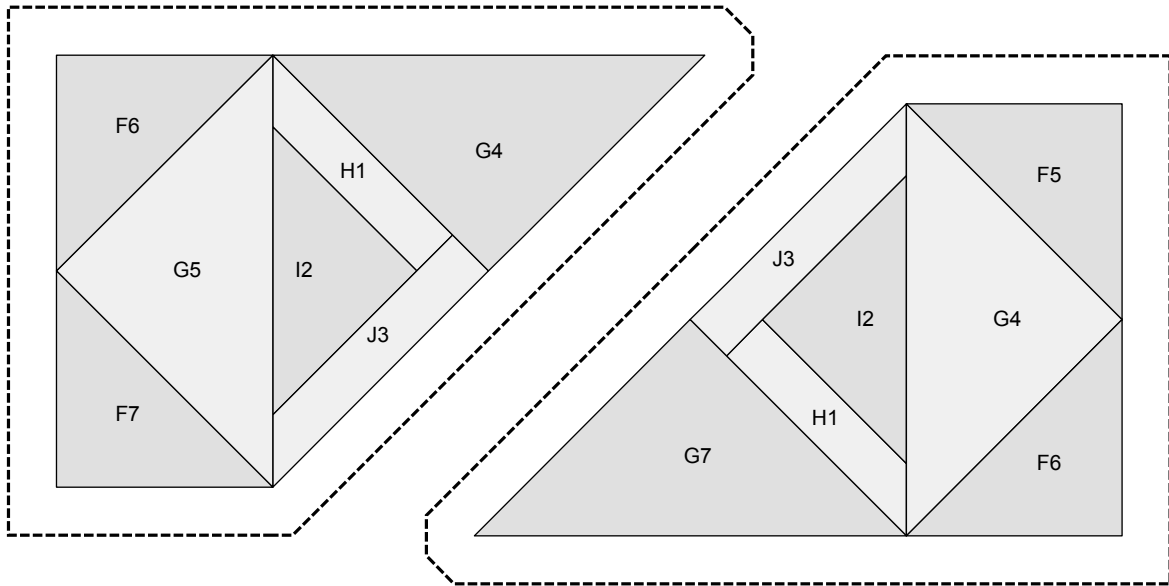
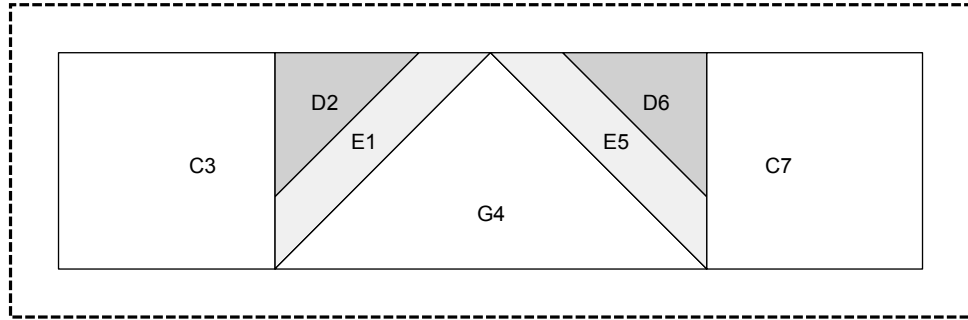

SET PRINTER TO "ACTUAL SIZE" WHEN PRINTING THIS PAGE.

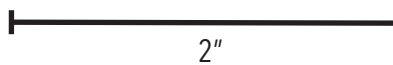
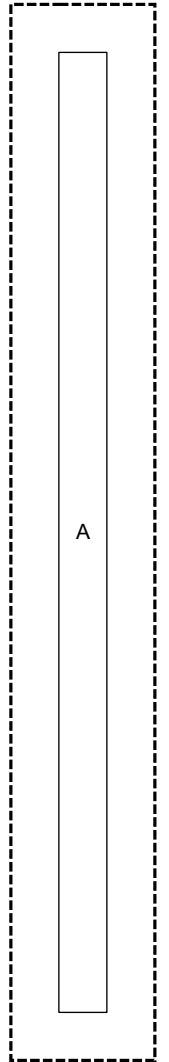
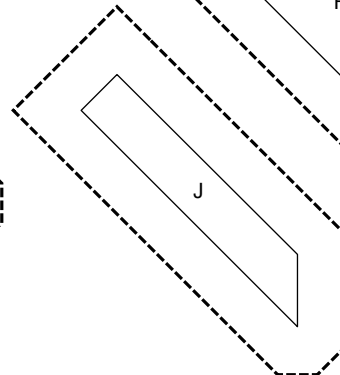
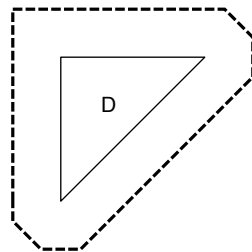
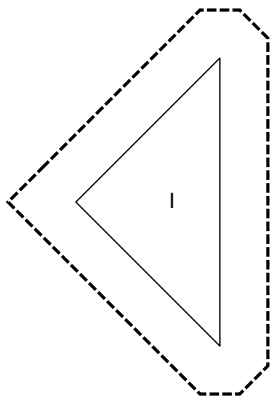
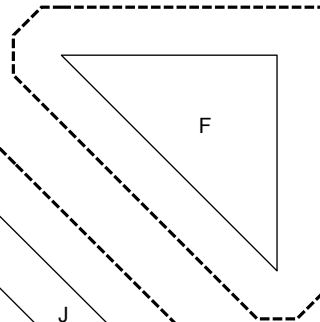
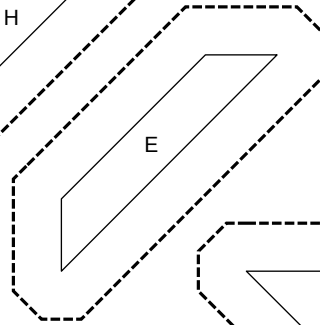
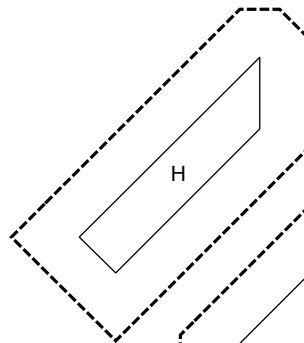
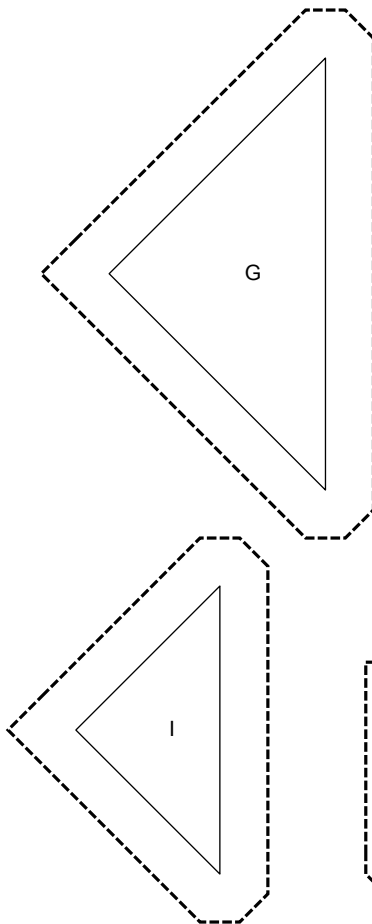
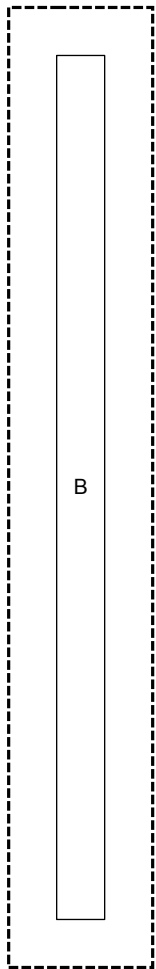
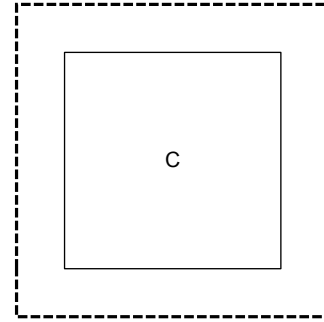
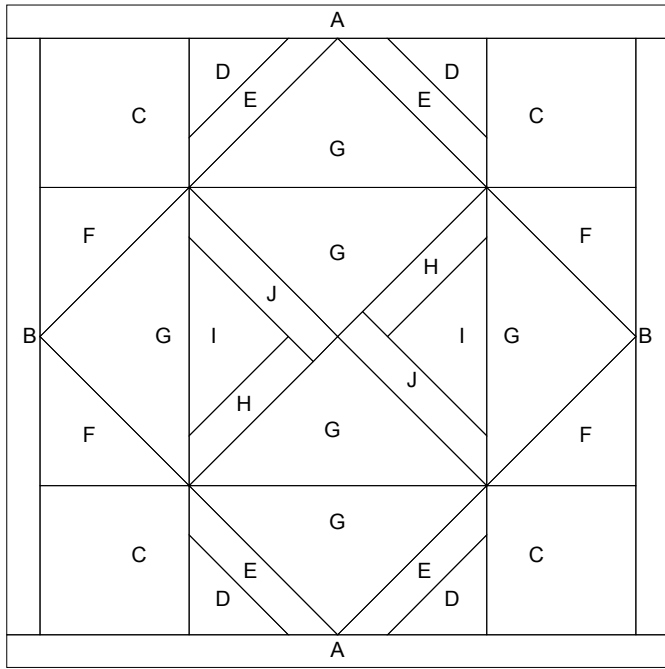

The Jane Stickle Quilt - Block H4

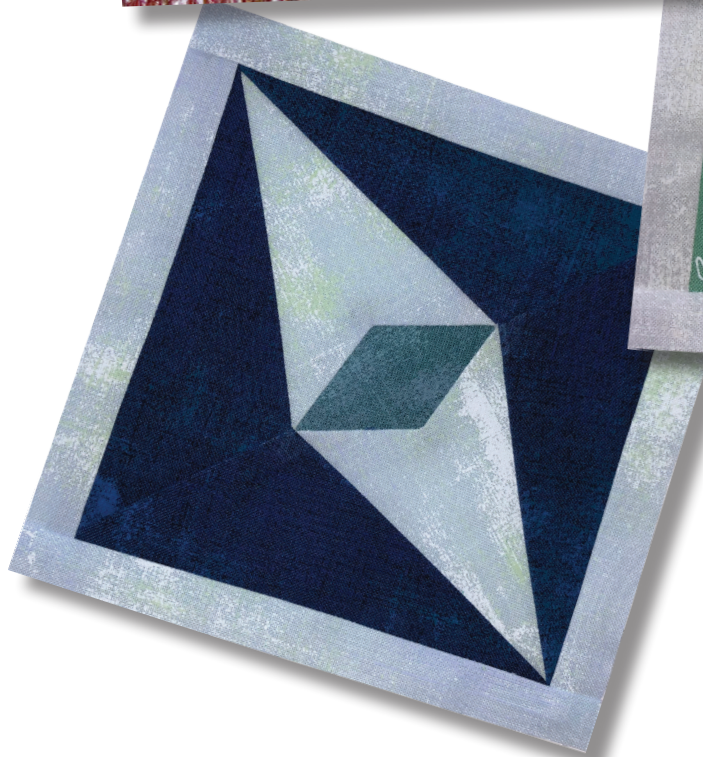
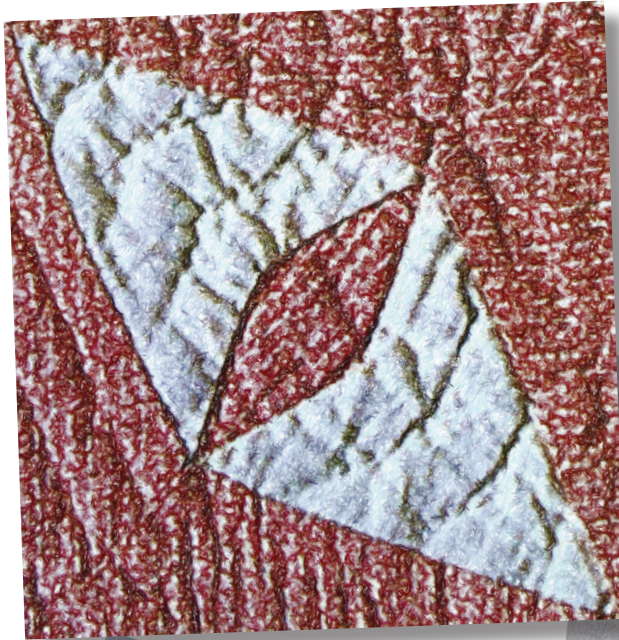

What you need:

Patches	Version 1 or 2	Version 3	Version 4
A*	(2) 1" x 6"	(2) 1" x 6"	(2) 1" x 6"
B*	(2) 1" x 5"	(2) 1" x 5"	(2) 1" x 5"
C	(2) 2½" x 6½"	(1) 6" x 6"-cut diagonally	(1) 6" x 6"-cut diagonally
D	(2) 2½" x 6½"	N/A	N/A
E	(2) 4½" x 3½"	(2) 4½" x 3½"	(1) 6" x 6"
F	(1) 2" x 3"	(1) 2" x 3"	(1) 2" x 3"

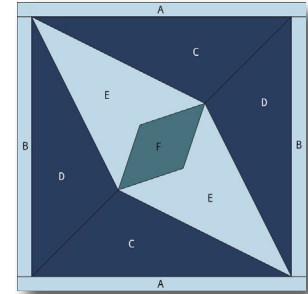

Hobbystash Colorway

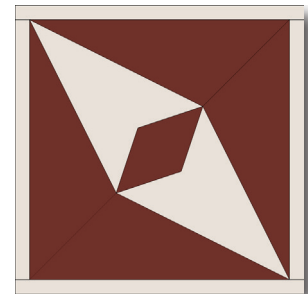

Jane Stickle Colorway

**The actual required width for Unit A and Unit B units is ¾". The increased width specified above allows for squaring the block to exactly 5½".*

Assembly:

1. Using templates on Page H4-2, foundation piece sections.
2. Assemble sections and sew together.
3. Join Unit B to the right side of the block, and then the left.
4. Join Unit A to the top of the block and then the bottom. Square up block to measure 5½" x 5½" square.

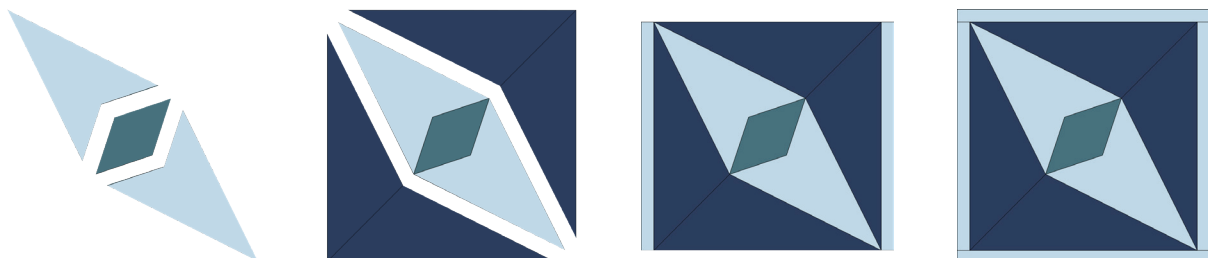

SET PRINTER TO "ACTUAL SIZE" WHEN PRINTING THIS PAGE.

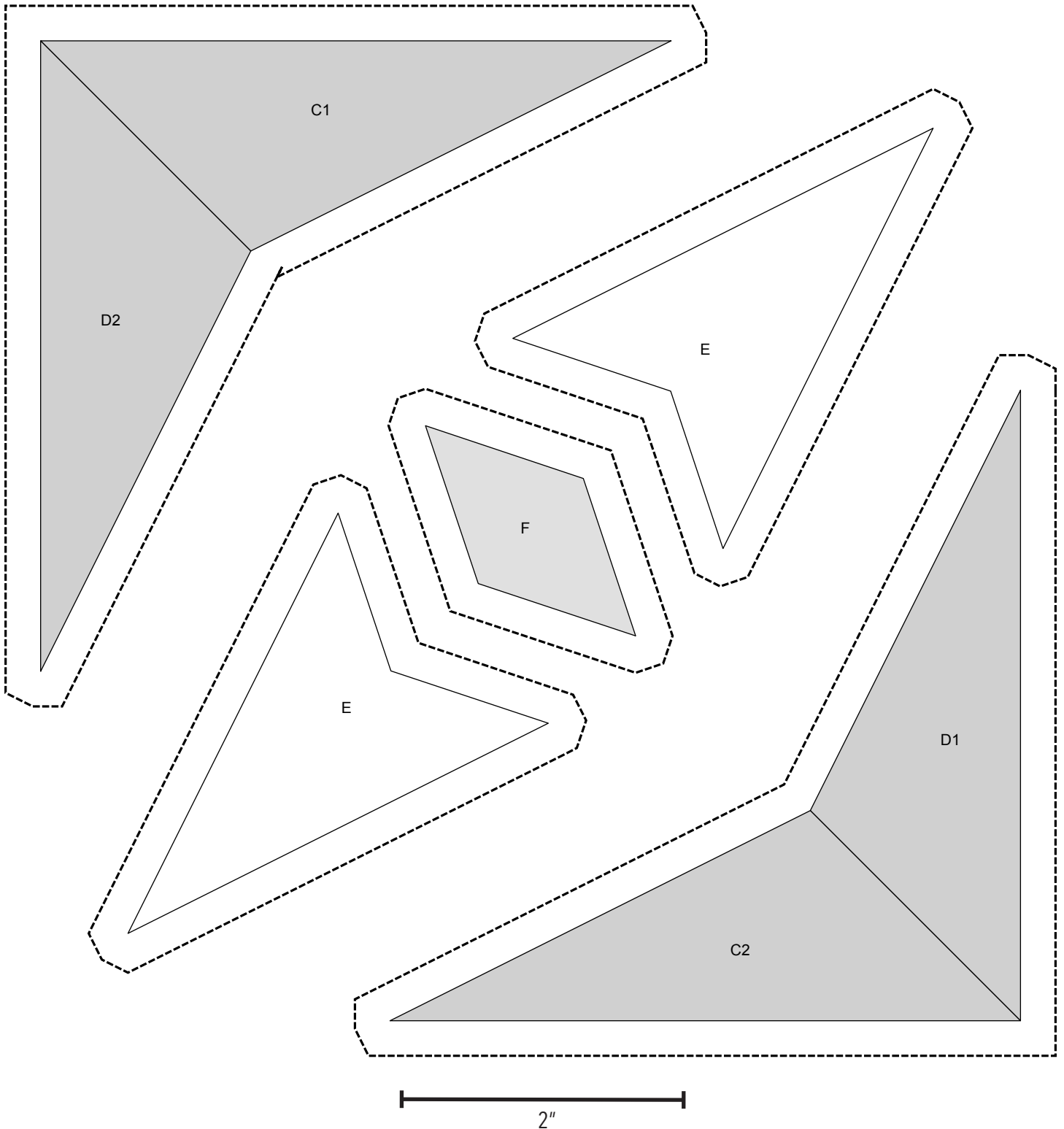

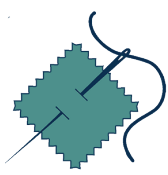

SET PRINTER TO "ACTUAL SIZE" WHEN PRINTING THIS PAGE.

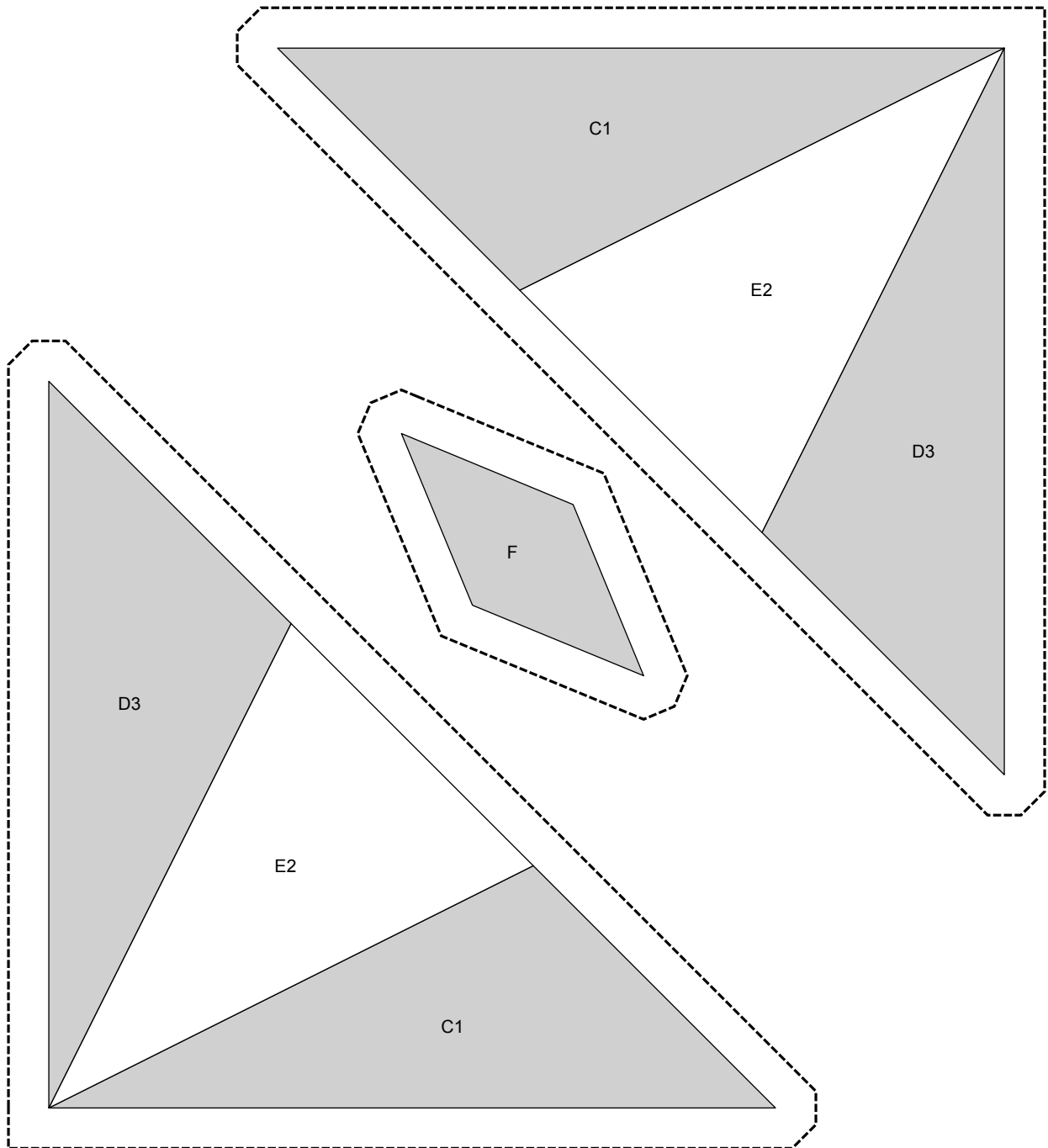

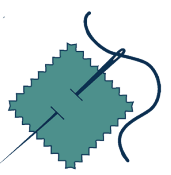

SET PRINTER TO "ACTUAL SIZE" WHEN PRINTING THIS PAGE.

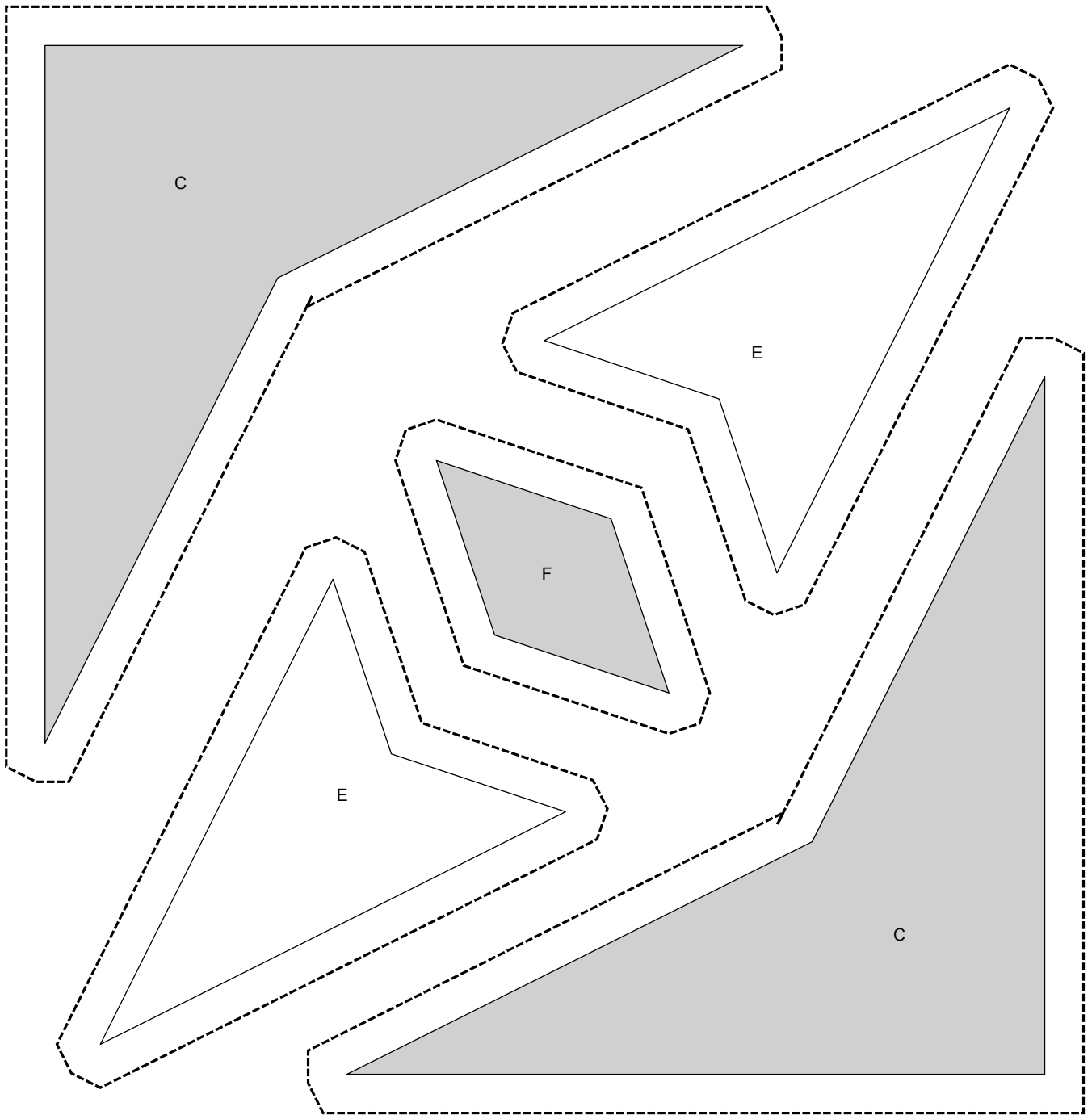

2"

SET PRINTER TO "ACTUAL SIZE" WHEN PRINTING THIS PAGE.

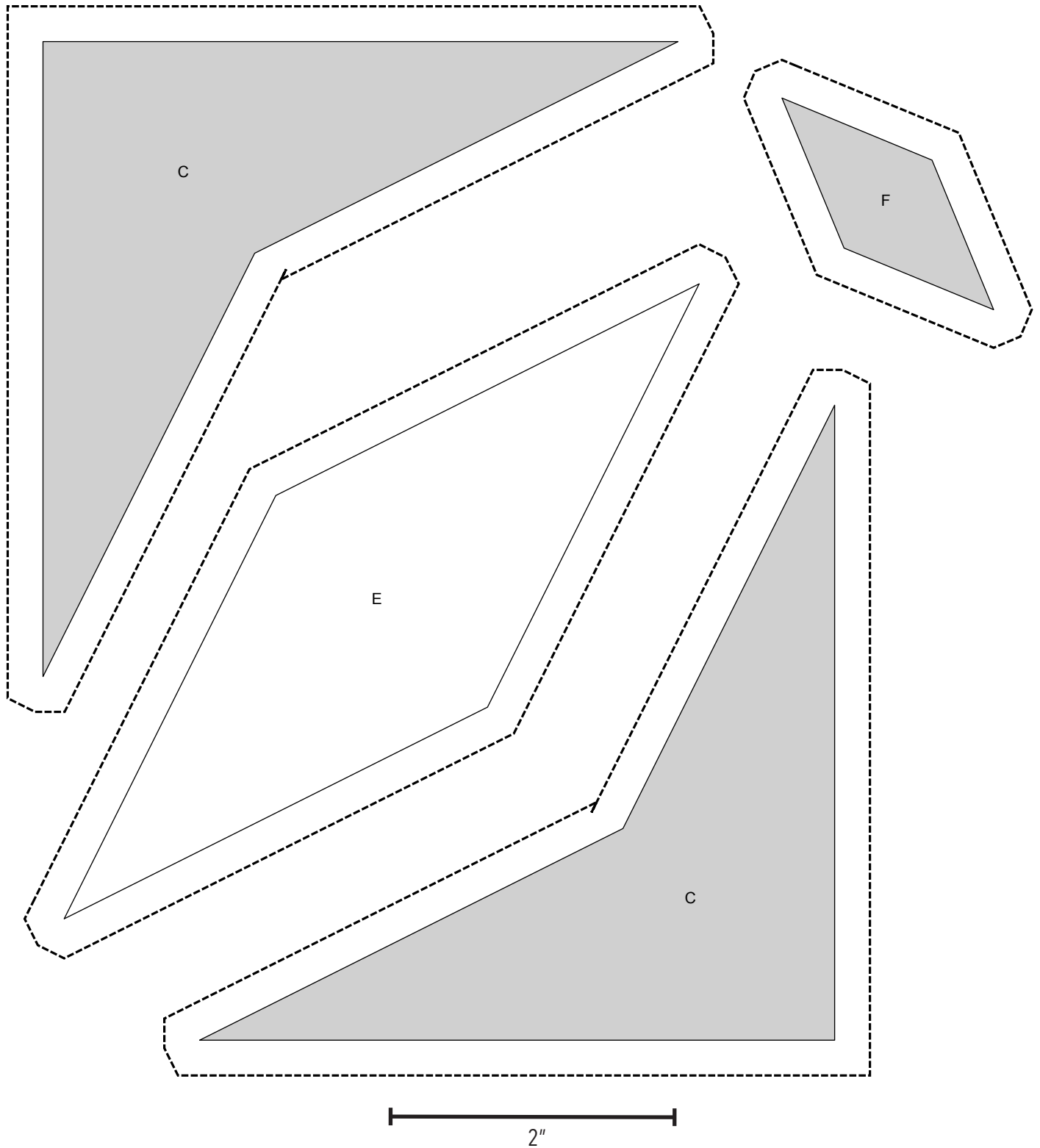

SET PRINTER TO "ACTUAL SIZE" WHEN PRINTING THIS PAGE.

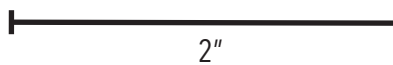
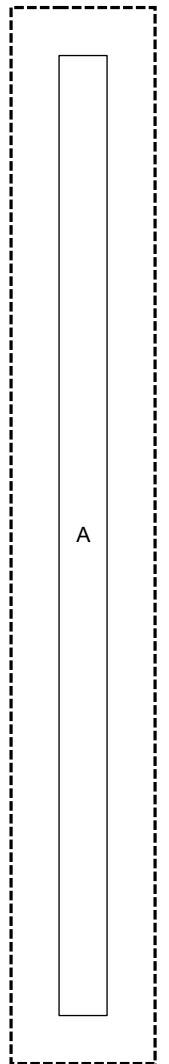
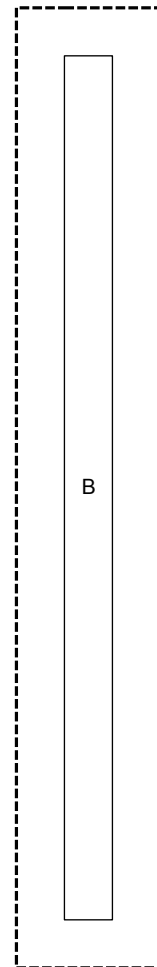
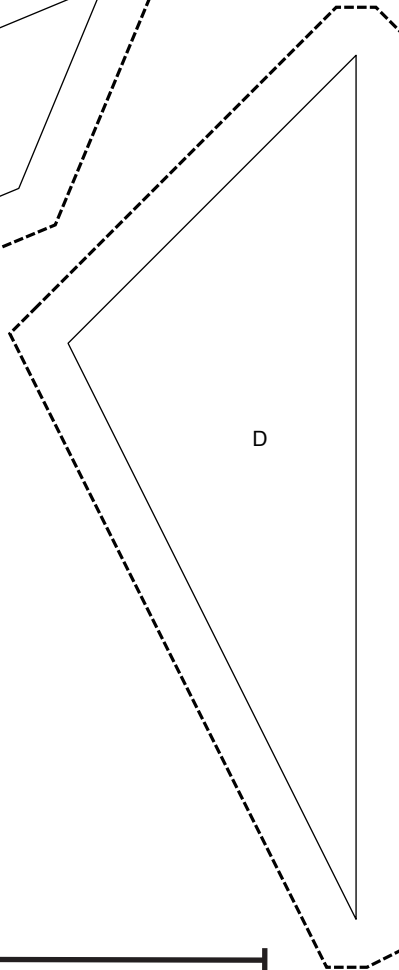
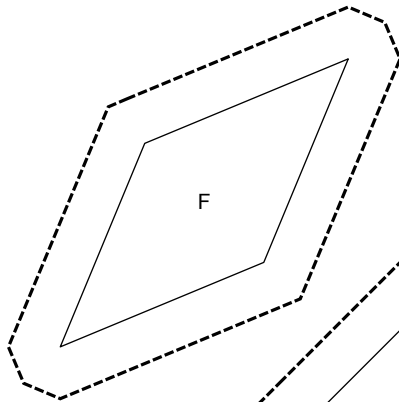
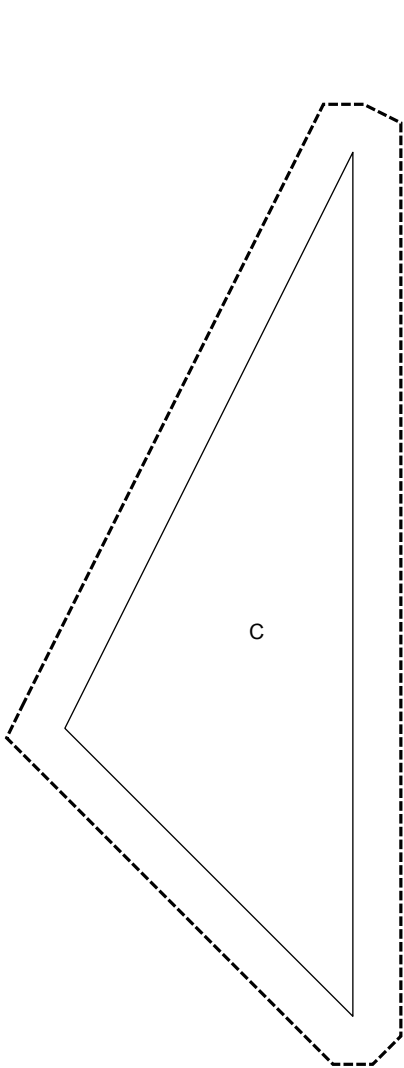
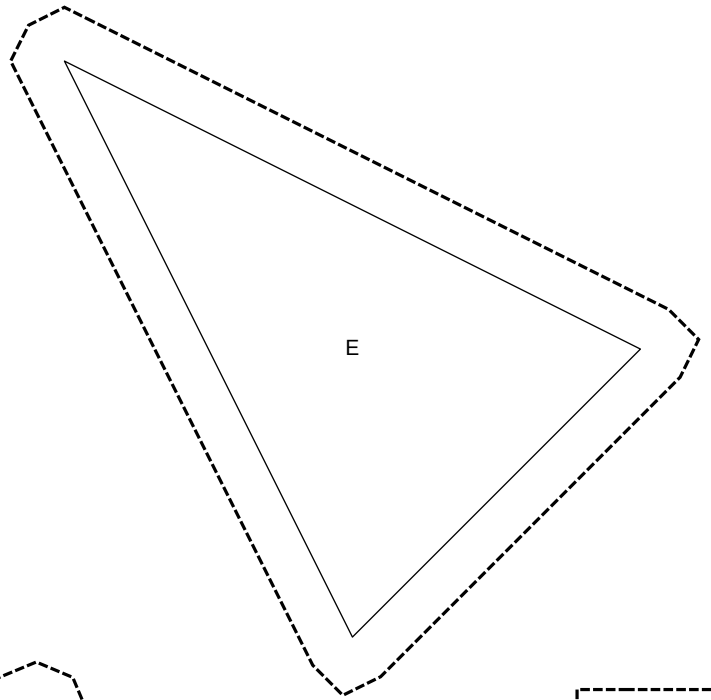
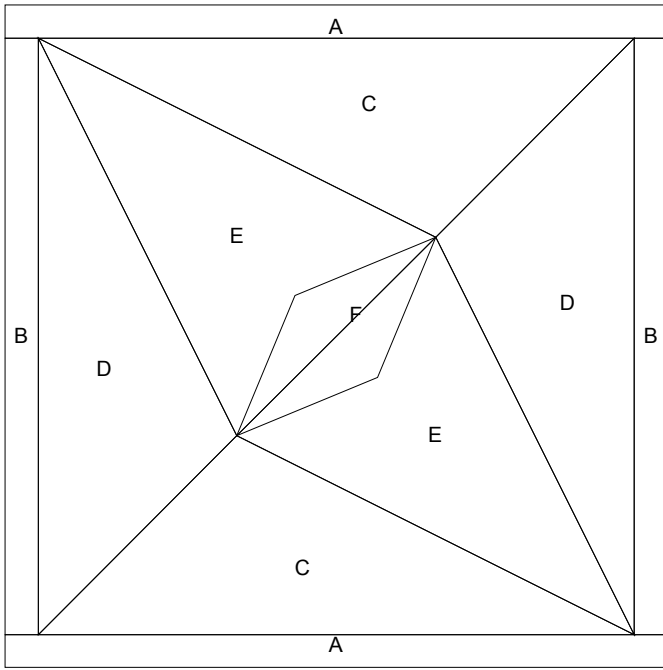

The Jane Stickle Quilt - Block H5

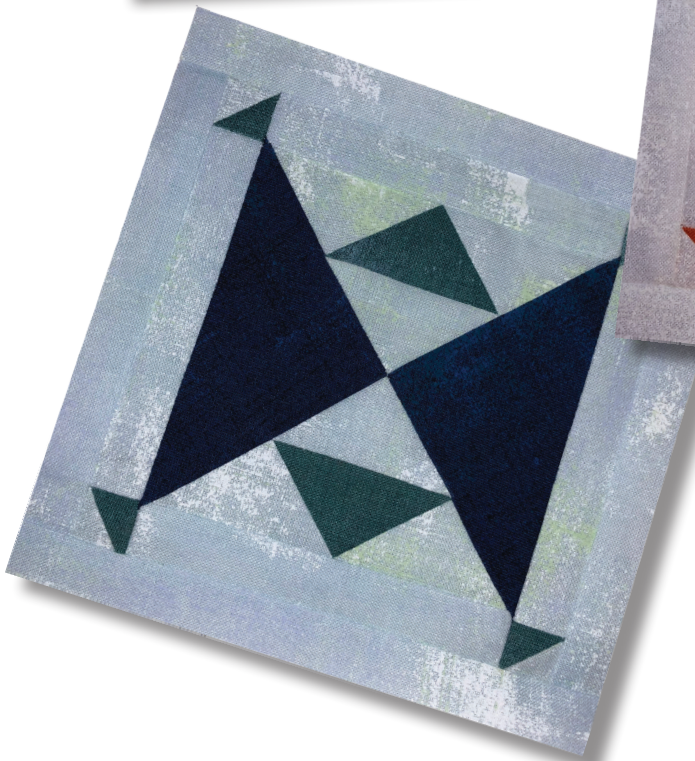

What you need:

Patches	Quantity/size
A*	(2) 1" x 6"
B*	(2) 1" x 5"
C	(2) 2" x 2" - green, cut once diagonally (2) 2" x 2" - light blue, cut once diagonally
D	(4) 1½" x 4½"
E	(2) 3½" x 3½" - light blue, cut twice diagonally (1) 3½" x 3½" - green, cut twice diagonally
F	(1) 4" x 4", cut once diagonally

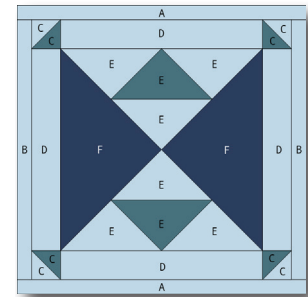

Hobbystash Colorway

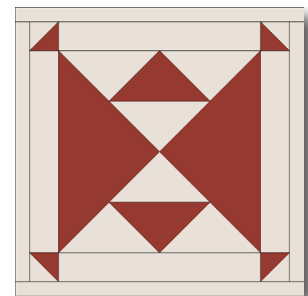

Jane Stickle Colorway

**The actual required width for Unit A and Unit B units is ¾". The increased width specified above allows for squaring the block to exactly 5½".*

Assembly:

1. Using templates on Page H5-2, foundation piece sections.
2. Assemble sections and sew together.
3. Join Unit B to the right side of the block, and then the left.
4. Join Unit A to the top of the block and then the bottom. Square up block to measure 5½" x 5½" square.

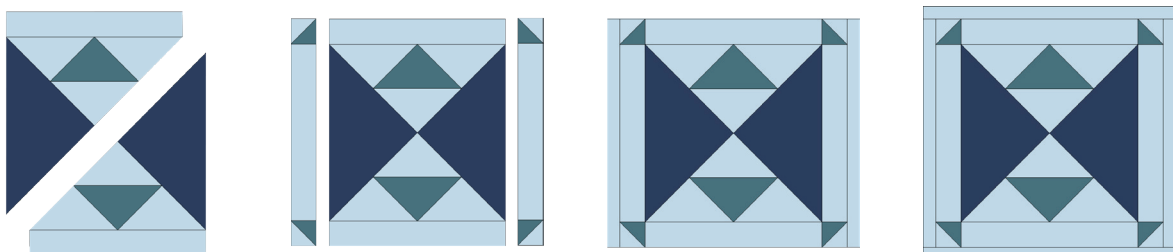

SET PRINTER TO "ACTUAL SIZE" WHEN PRINTING THIS PAGE.

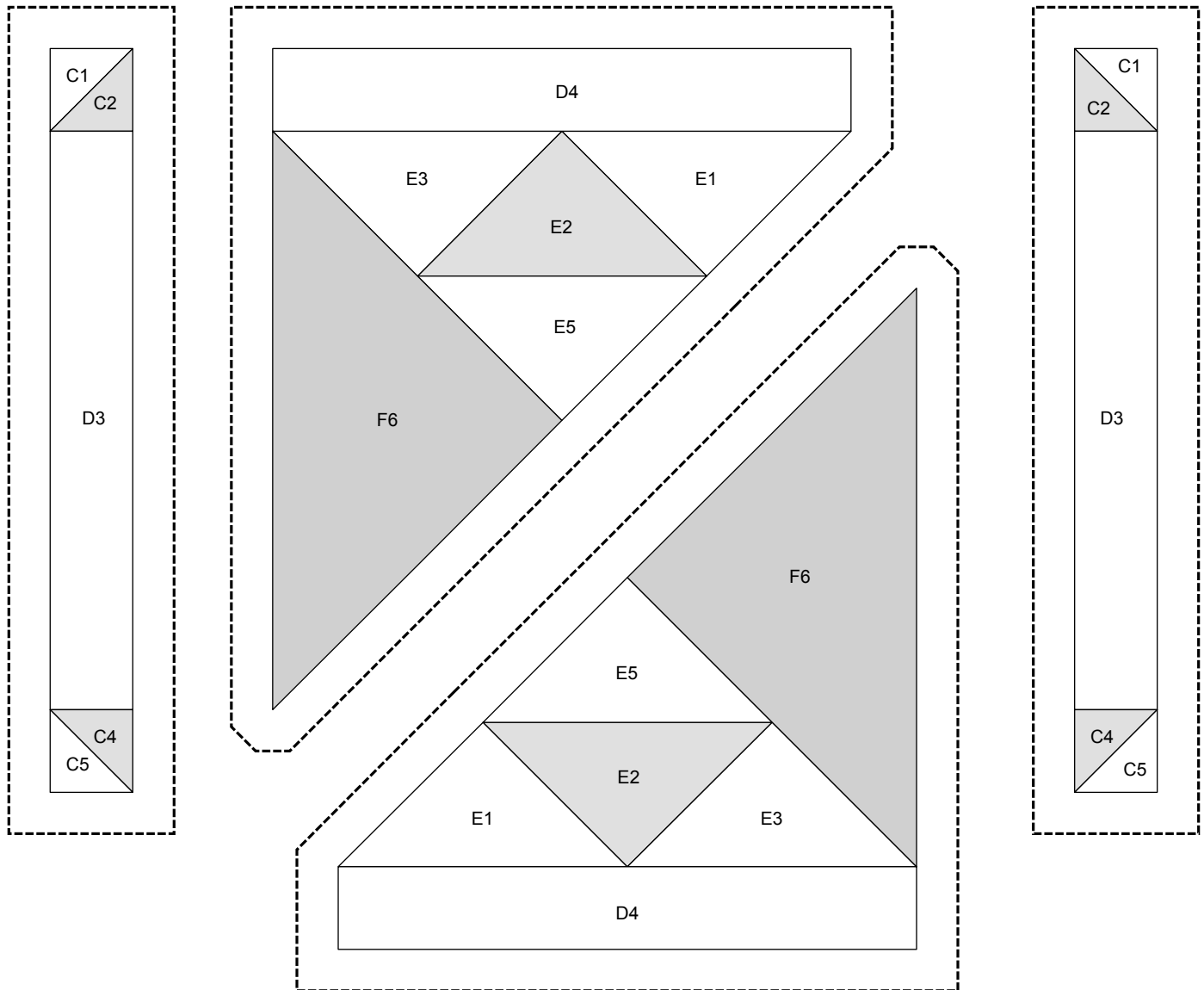

2"

SET PRINTER TO "ACTUAL SIZE" WHEN PRINTING THIS PAGE.

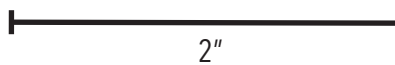
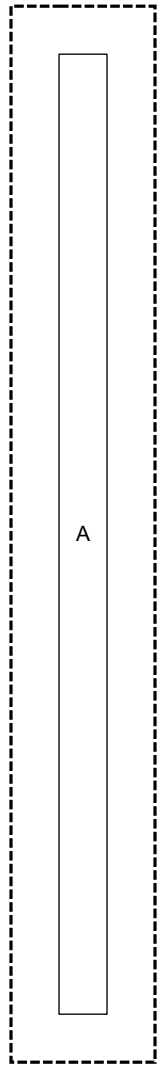
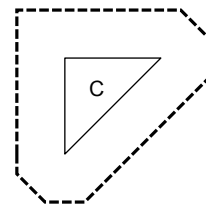
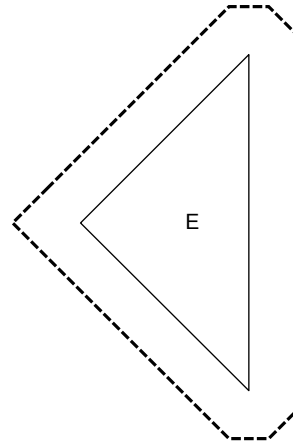
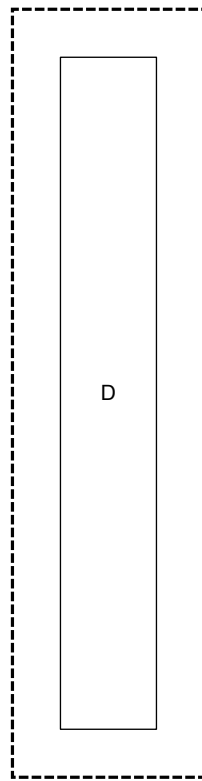
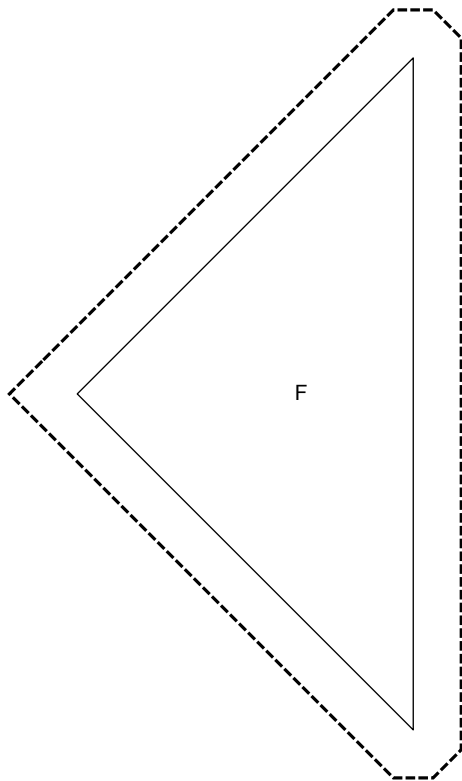
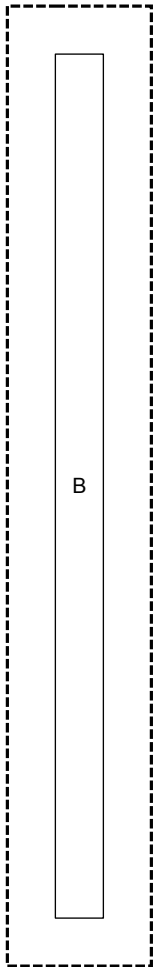
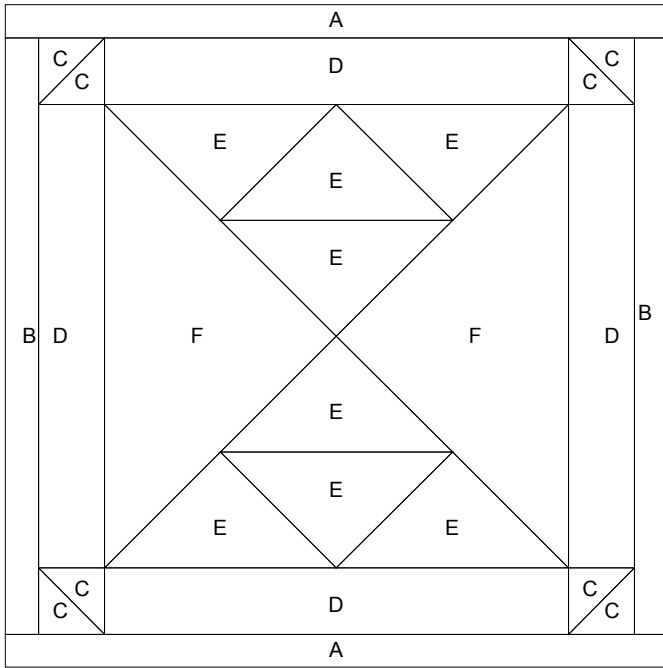

The Jane Stickle Quilt - Block H6

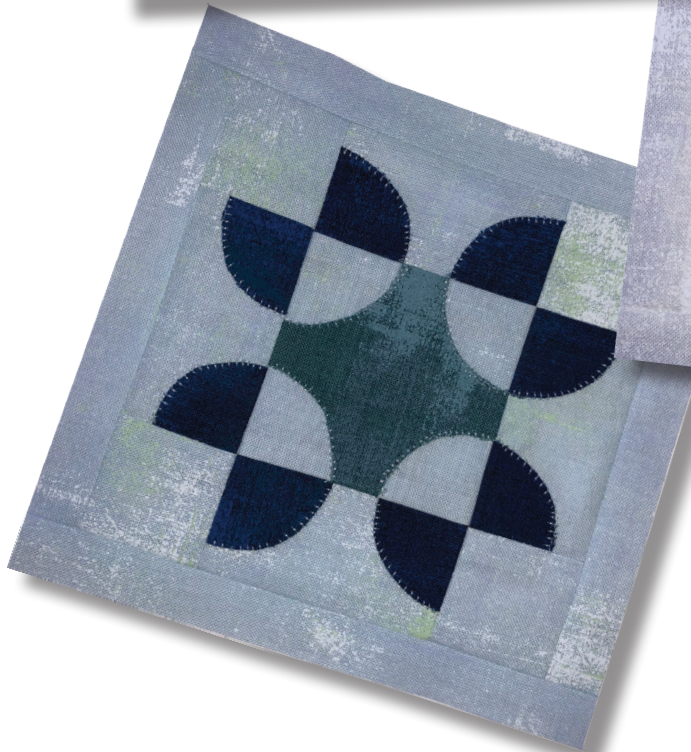
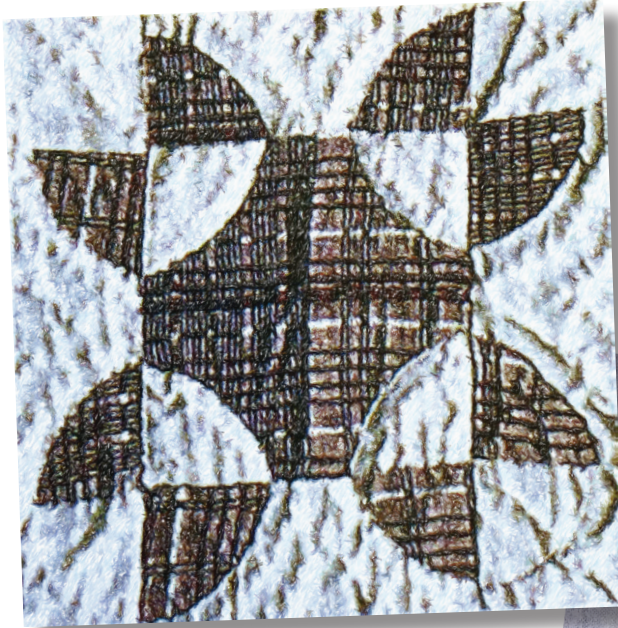

What you need:

Patches	Quantity/size (foundation)	Quantity/size (traditional piecing)
A*	(2) 1" x 6"	(2) 1" x 6"
B*	(2) 1" x 5"	(2) 1" x 5"
C	(4) 2" x 2"	(4) 1⅝" x 1⅝"
D	(4) 2" x 3"	(4) 1⅝" x 2¾"
E	(8) 1½" x 1½" - navy (4) 1½" x 1½" - light blue	(8) 1½" x 1½" - navy (1) 2¾" x 2¾" - light blue
F	(1) 3" x 3"	(1) 3" x 3"

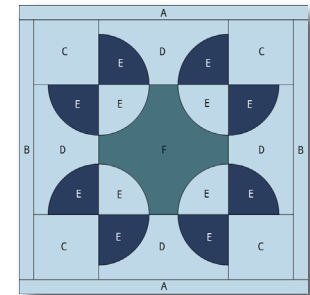

Hobbystash Colorway

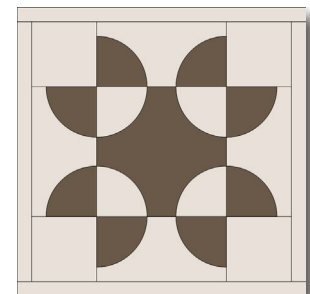

Jane Stickle Colorway

**The actual required width for Unit A and Unit B units is ¾". The increased width specified above allows for squaring the block to exactly 5½".*

Assembly:

- Using templates on Page H6-2 and H6-3, curve piece or appliqué two navy Unit E to Unit D. Make 4.
- Using templates on Page H6-2 and H6-3, curve piece four light blue Unit E to one Unit F, OR appliqué one Unit F to light blue Unit E.
- Sew Unit C to each side of two Step 1 patches.
- Sew remaining two Step 1 patches to each side of Step 2 patch.
- Arrange rows from Step 3 and Step 4 as shown and sew together.
- Join Unit B to the right side of the block, and then the left.
- Join Unit A to the top of the block and then the bottom. Square up block to measure 5½" x 5½" square.

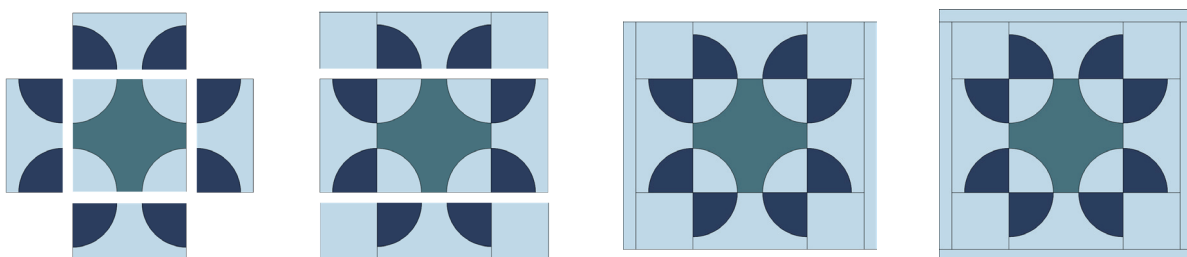

SET PRINTER TO "ACTUAL SIZE" WHEN PRINTING THIS PAGE.

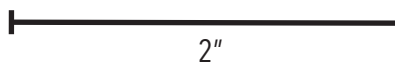
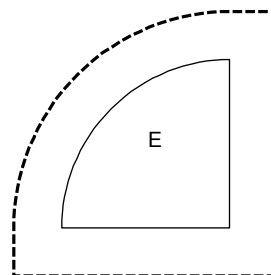
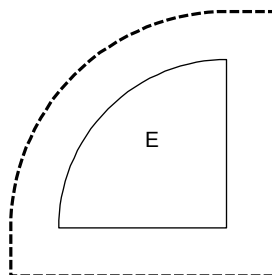
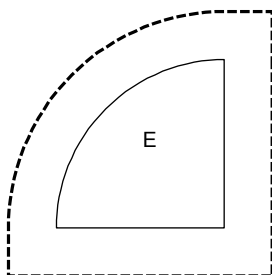
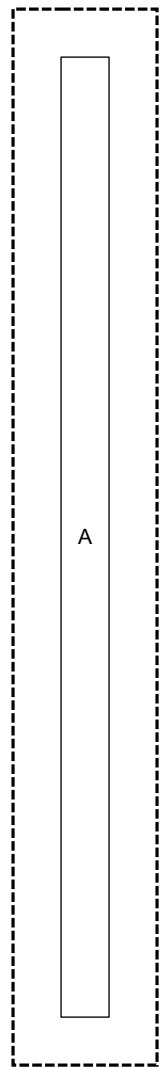
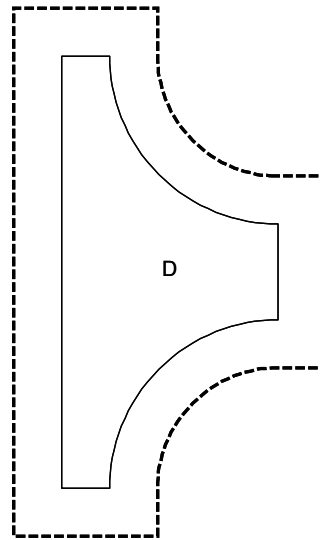
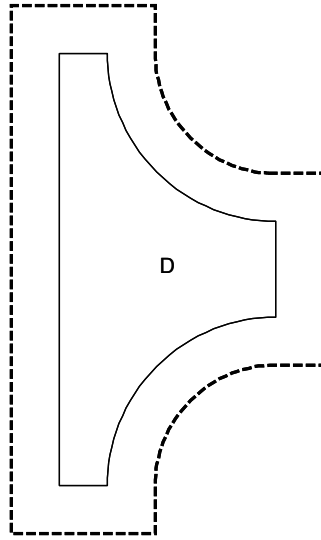
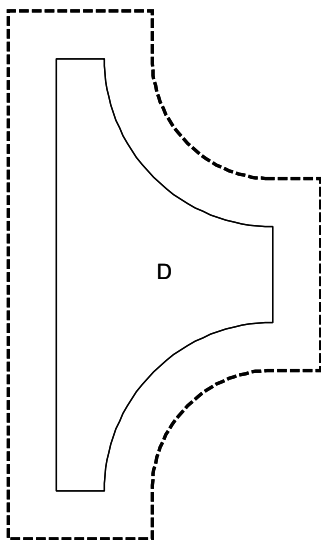
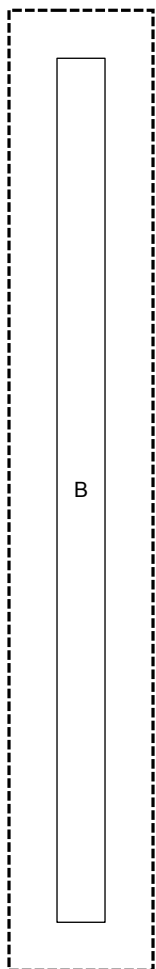
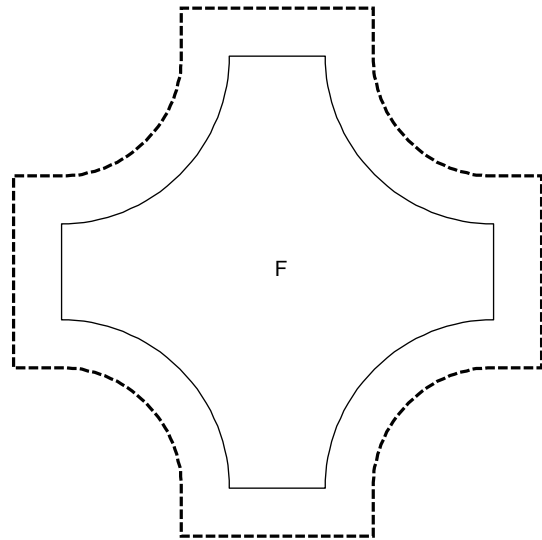
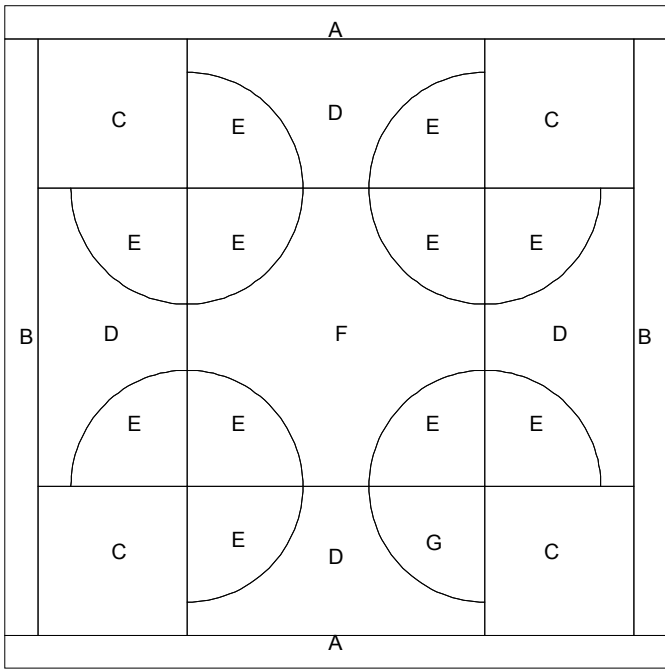

SET PRINTER TO "ACTUAL SIZE" WHEN PRINTING THIS PAGE.

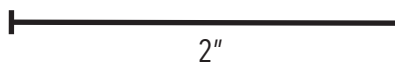
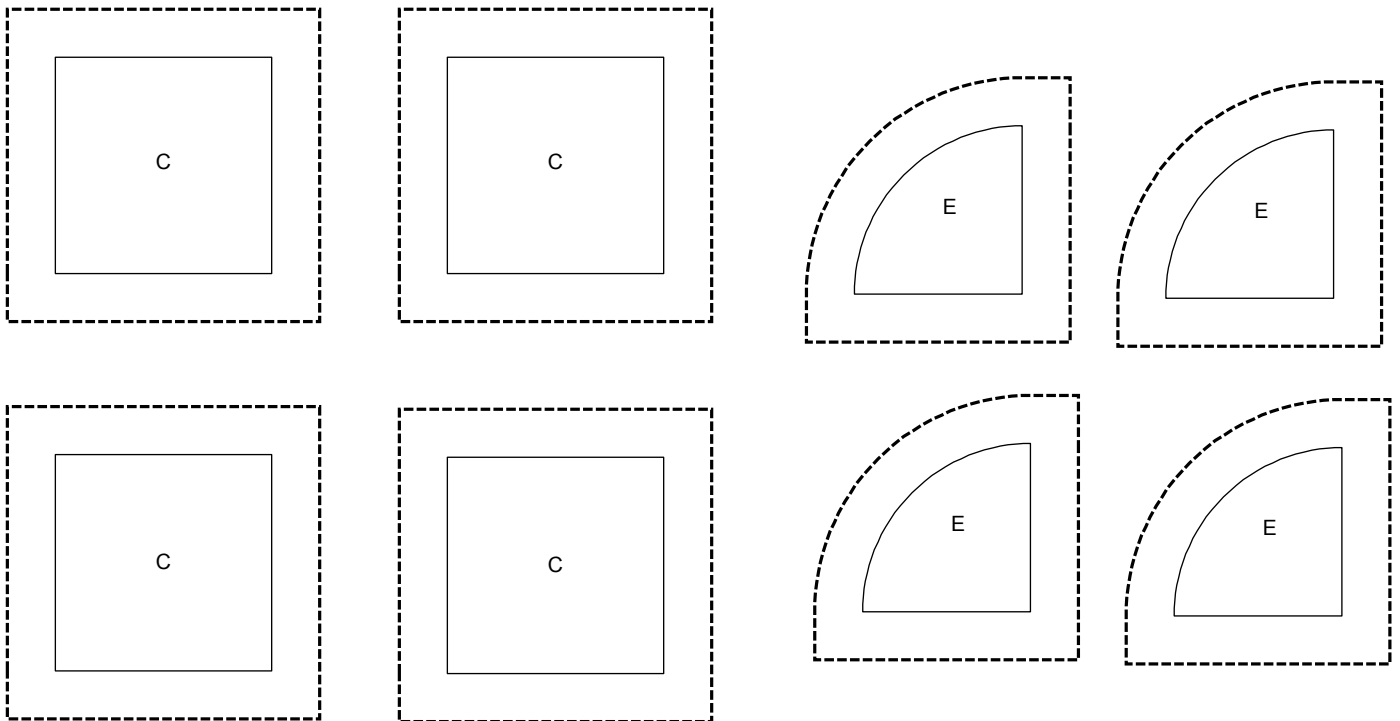
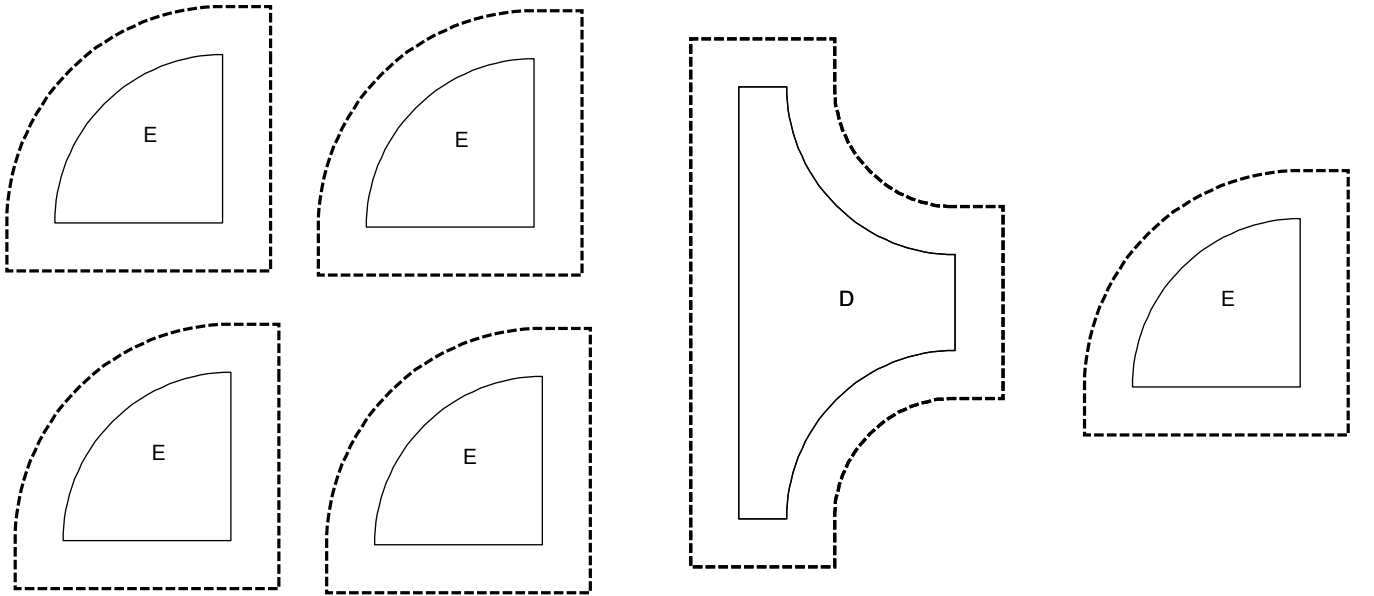

The Jane Stickle Quilt - Block H7

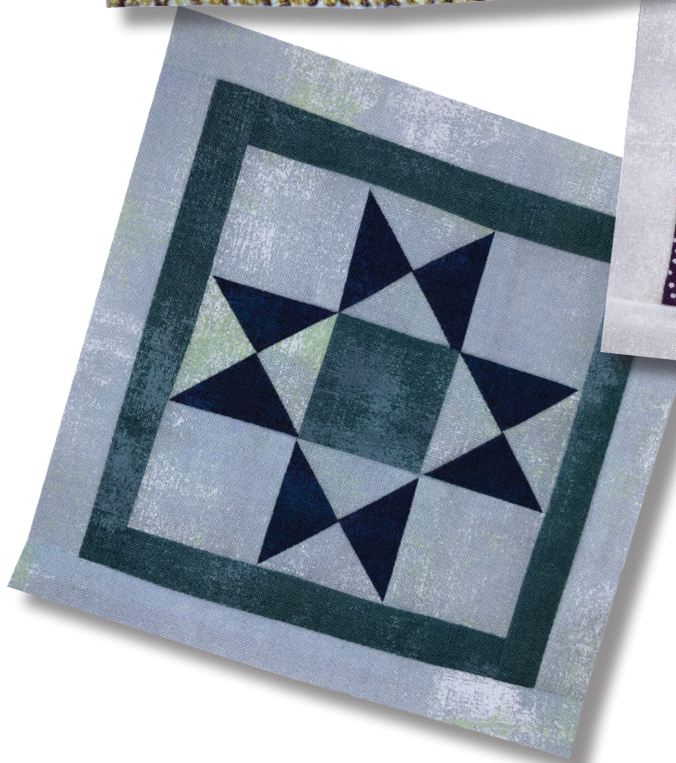

What you need:

Patches	Quantity/size
A*	(2) 1" x 6"
B*	(2) 1" x 5"
C	(2) 7/8" x 5"
D	(2) 7/8" x 4¼"
E	(4) 1¾" x 1¾" - light blue (1) 1¾" x 1¾" - green
F	(2) 2½" x 2½" - light blue (2) 2½" x 2½" - navy

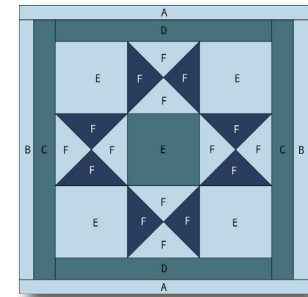

Hobbystash Colorway

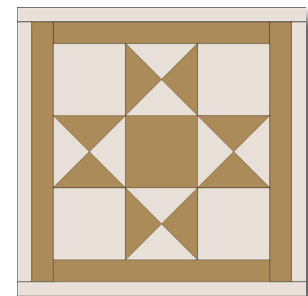

Jane Stickle Colorway

**The actual required width for Unit A and Unit B units is ¾". The increased width specified above allows for squaring the block to exactly 5½".*

Assembly:

- Referring to BASIC INSTRUCTIONS, make 4 HST units using the Unit F patches.
- On the reverse side of one HST unit, draw a diagonal line from corner to corner opposite the seam. Align with second HST unit right sides together, with contrasting colors facing each other. Sew two seams, each 1/4" away from drawn line. Cut apart on the drawn line and press open. Repeat the process for a total of 4 quarter-square triangle (QST) units. The QST units should measure 1¾" x 1¾" square.
- Sew a light blue Unit E to each side of two QST units. Sew the remaining QST units to each side of green Unit E as shown.
- Join Unit D to the top of the block, and then the bottom.
- Join Unit C to the right side of the block, and then the left.
- Join Unit B to the right side of the block, and then the left.
- Join Unit A to the top of the block and then the bottom. Square up block to measure 5½" x 5½" square.

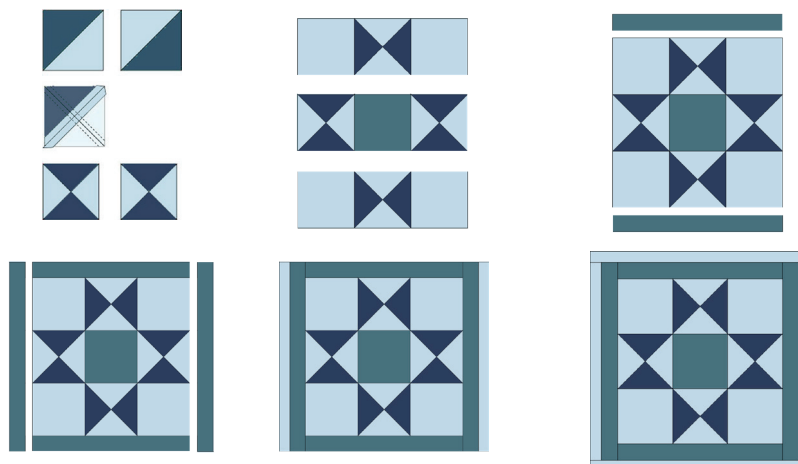

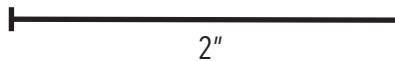
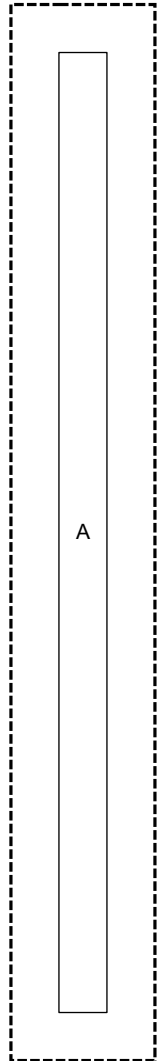
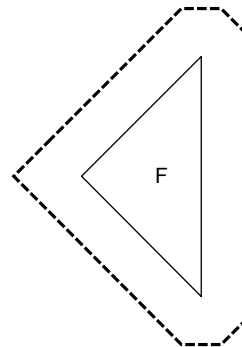
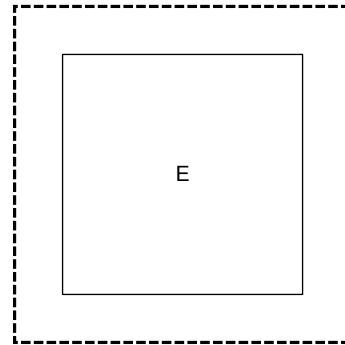
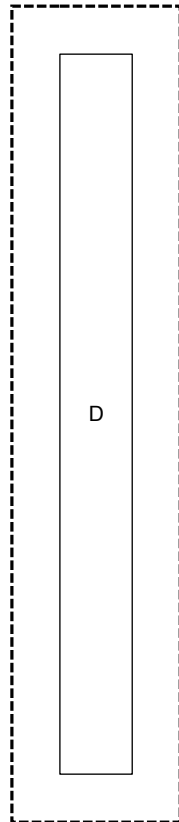
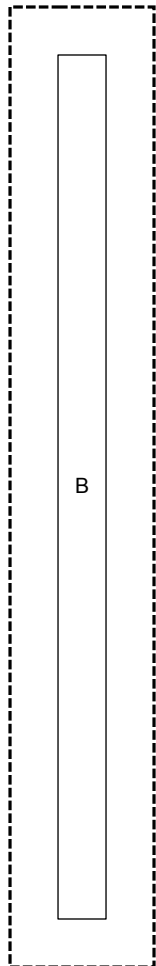
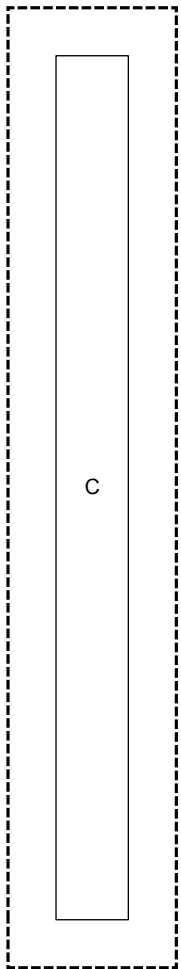
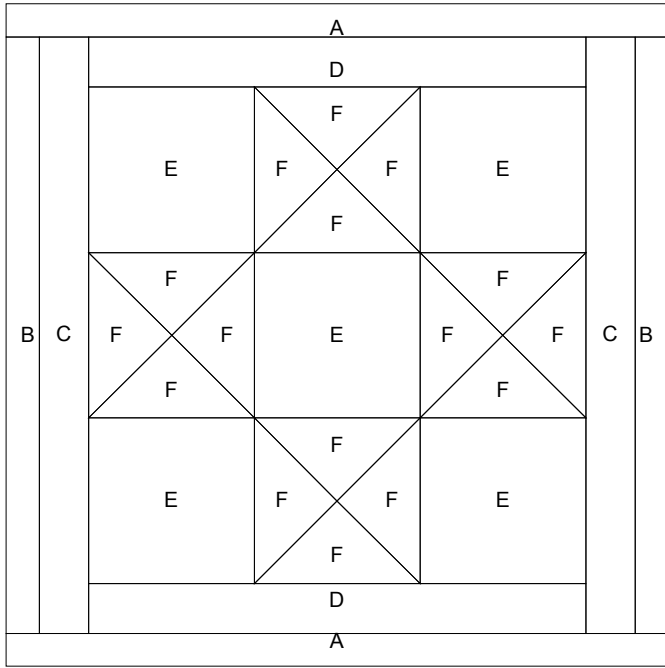

SET PRINTER TO "ACTUAL SIZE" WHEN PRINTING THIS PAGE.



The Jane Stickle Quilt - Block H8



What you need:

Patches	Quantity/size
A*	(2) 1" x 6"
B*	(2) 1" x 5"
C 	(2) 2½" x 2½", cut once diagonally
D	(4) 1½" x 2½"
E	(4) 1½" x 2½"
F 	(4) 2" x 2" - green, cut once diagonally (4) 2" x 2" - lt blue, cut once diagonally
G	(4) 1½" x 5"
H	(4) 2" x 2"
I	(2) 1" x 2"
J	(1) 1" x 4"

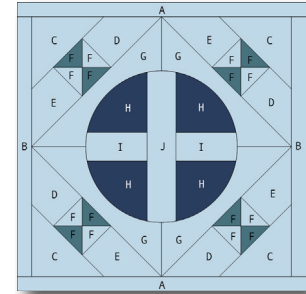

Hobbystash Colorway

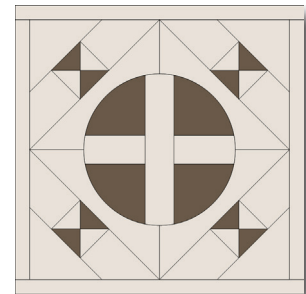

Jane Stickle Colorway

**The actual required width for Unit A and Unit B units is ¾". The increased width specified above allows for squaring the block to exactly 5½".*

Assembly:

- Using templates on Page H8-2, foundation piece sections.
- Assemble inner circle sections and sew together. Join foundation halves and appliqué to circle patch.
- Using the template provided on Page H8-3, foundation piece sections. Sew corners to Step 2 patch.
- Join Unit B to the right side of the block, and then the left.
- Join Unit A to the top of the block and then the bottom. Square up block to measure 5½" x 5½" square.

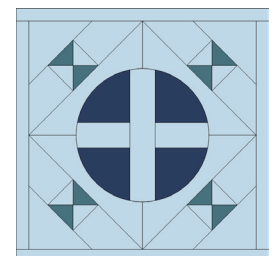
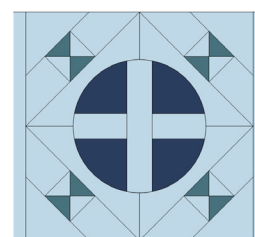
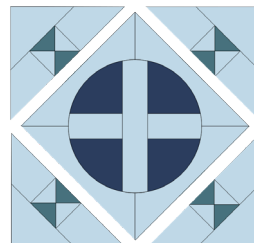
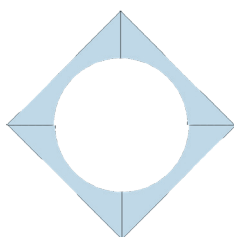

SET PRINTER TO "ACTUAL SIZE" WHEN PRINTING THIS PAGE.

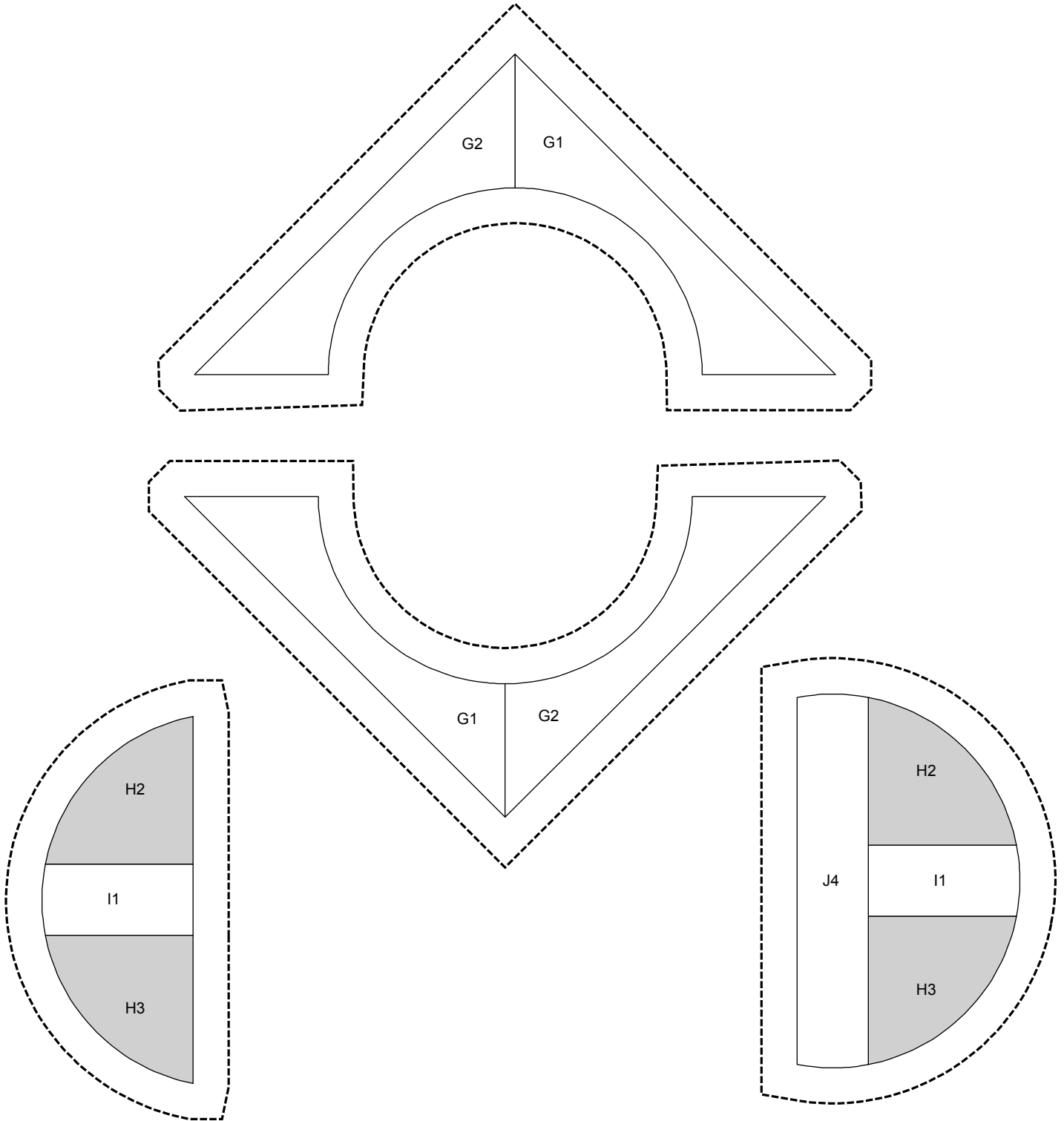

SET PRINTER TO "ACTUAL SIZE" WHEN PRINTING THIS PAGE.

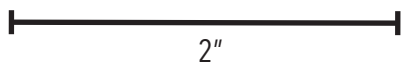
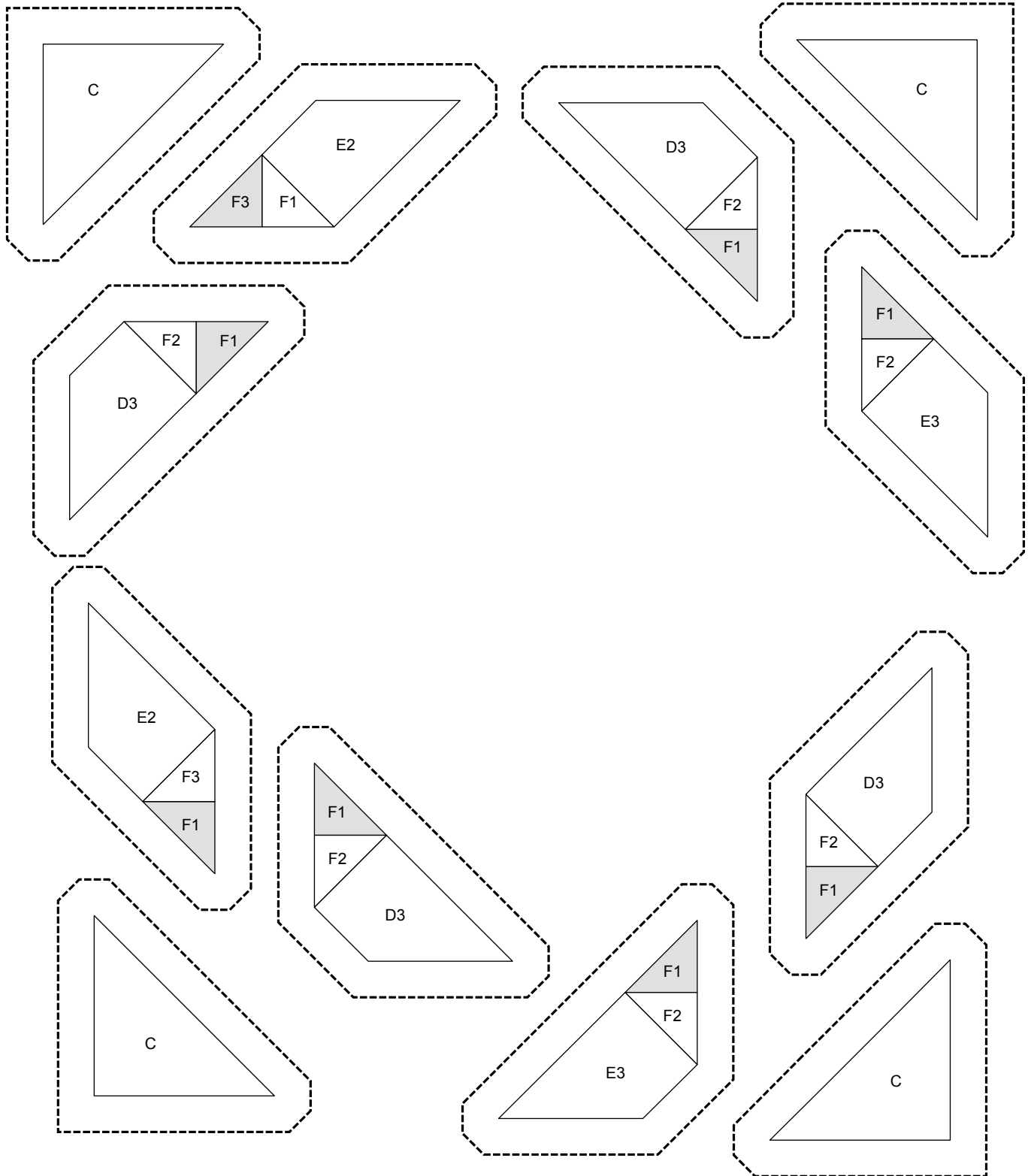

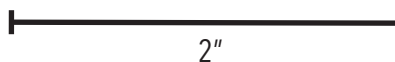
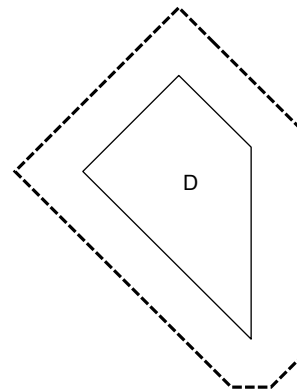
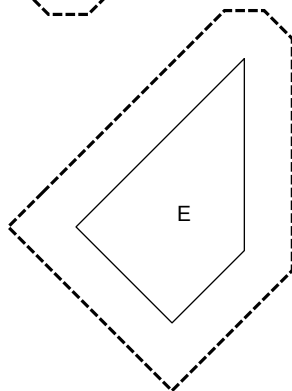
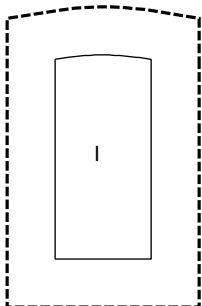
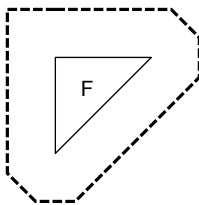
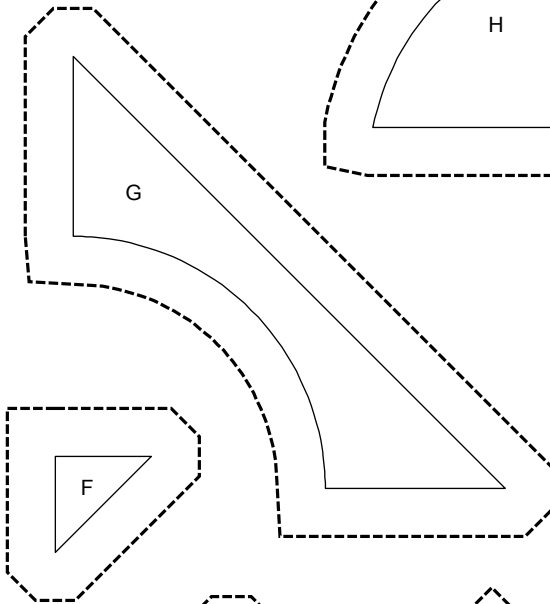
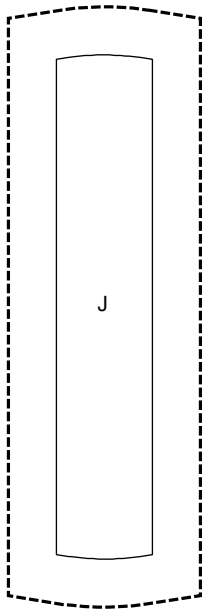
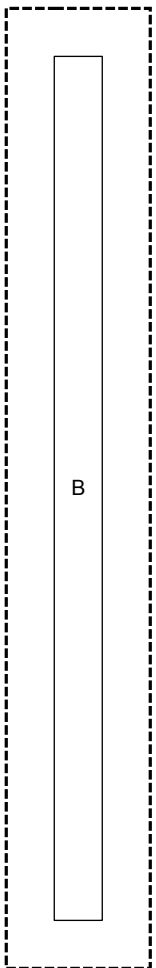
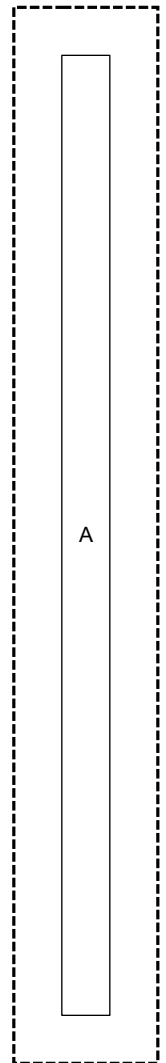
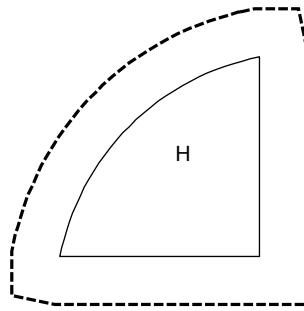
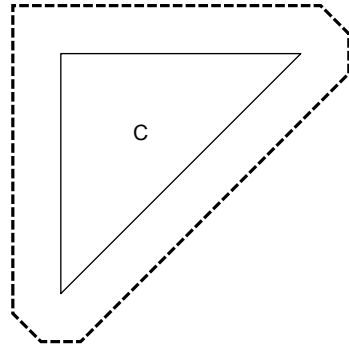
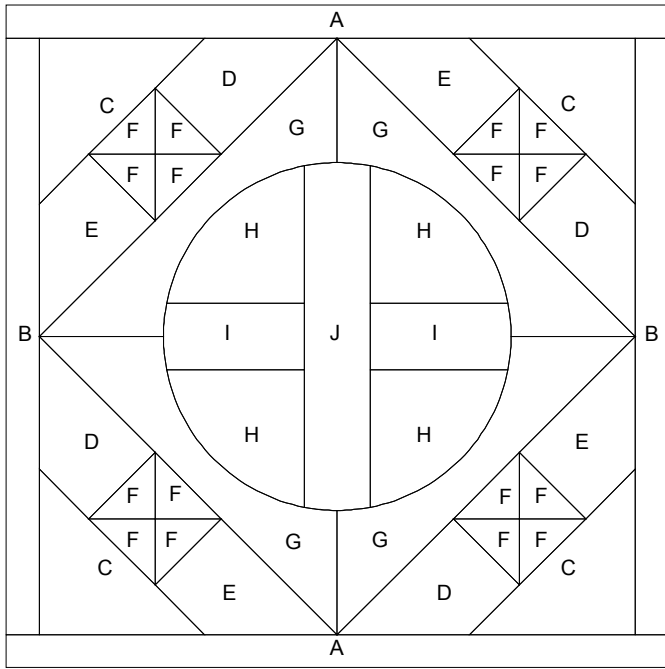

SET PRINTER TO "ACTUAL SIZE" WHEN PRINTING THIS PAGE.



The Jane Stickle Quilt - Block H9



What you need:

Patches	Quantity/size
A*	(2) 1" x 6"
B*	(2) 1" x 5"
C 	(2) 3" x 3", cut once diagonally
D	(4) 1" x 3"
E	(4) 2½" X 2½"
F	(4) 1¼" x 3"
G	(4) 1" x 3"
H	(4) 1½" X 2"
I	(4) 1½" X 1½"
J 	(1) 2½" X 2½", cut twice diagonally

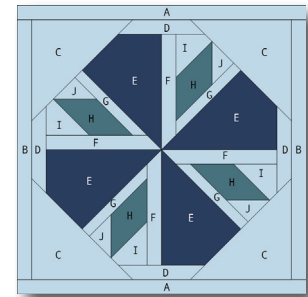

Hobbystash Colorway

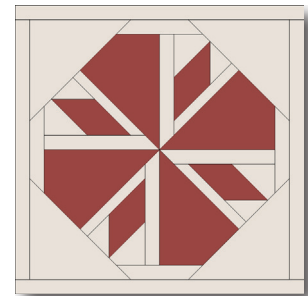

Jane Stickle Colorway

**The actual required width for Unit A and Unit B units is ¾". The increased width specified above allows for squaring the block to exactly 5½".*

Assembly:

- Using templates on Page H9-2, foundation piece sections.
- Assemble sections and sew together.
- Join Unit B to the right side of the block, and then the left.
- Join Unit A to the top of the block and then the bottom. Square up block to measure 5½" x 5½" square.

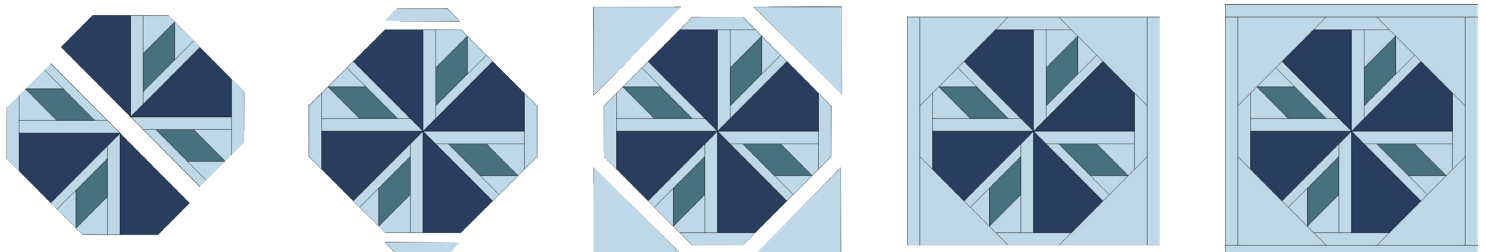

SET PRINTER TO "ACTUAL SIZE" WHEN PRINTING THIS PAGE.

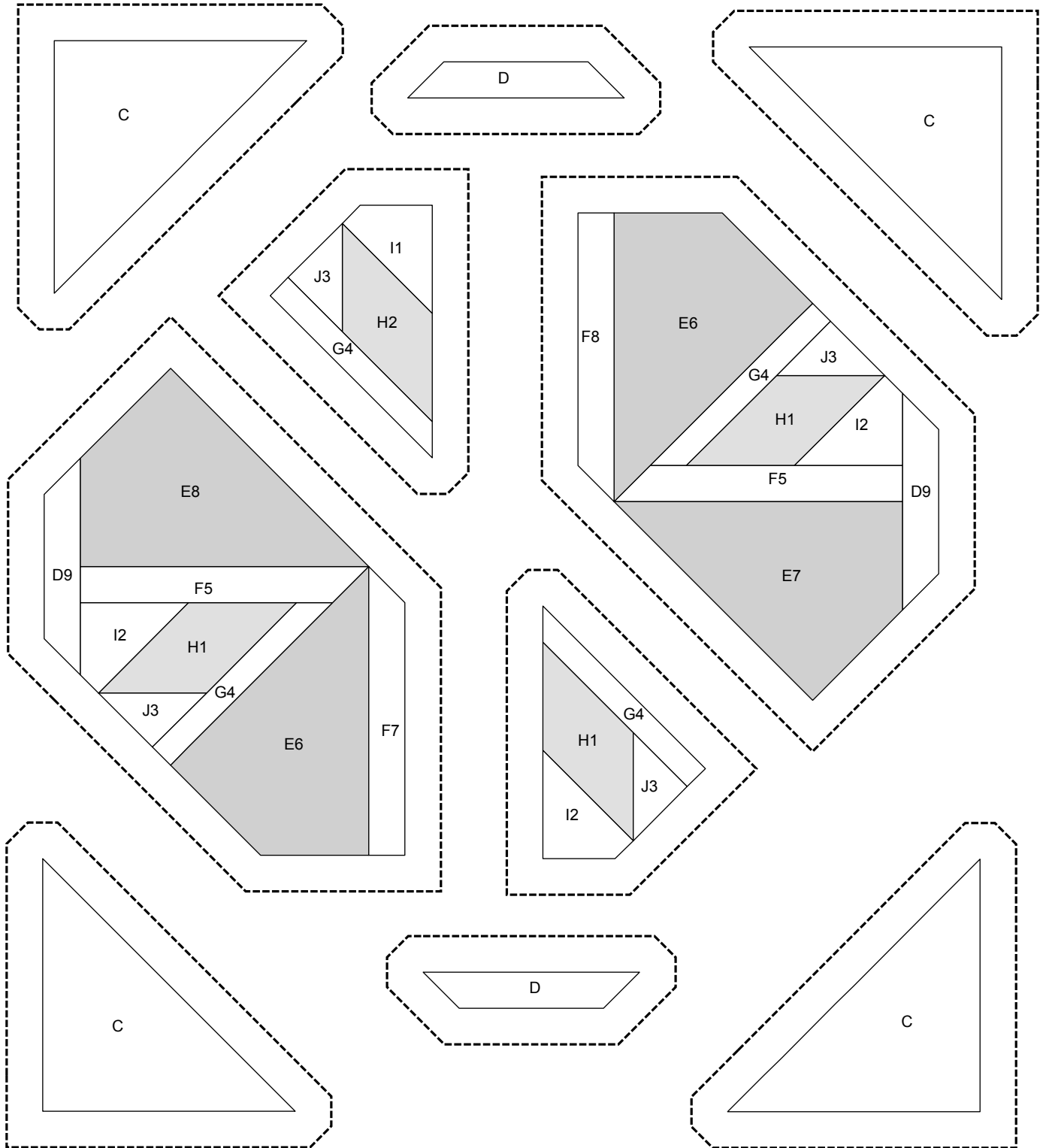

2"

SET PRINTER TO "ACTUAL SIZE" WHEN PRINTING THIS PAGE.

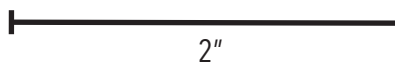
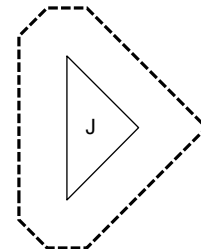
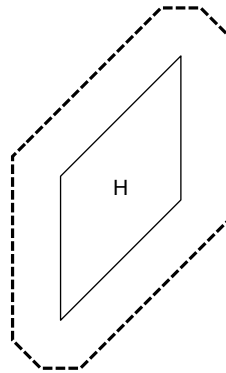
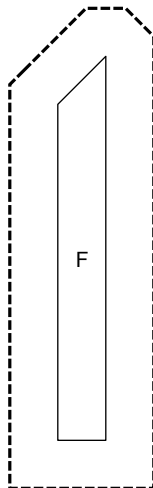
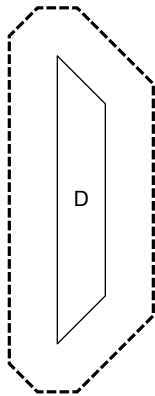
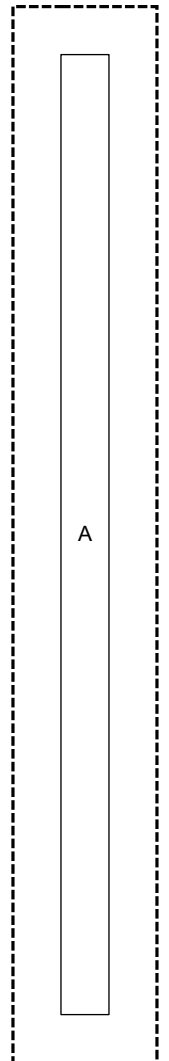
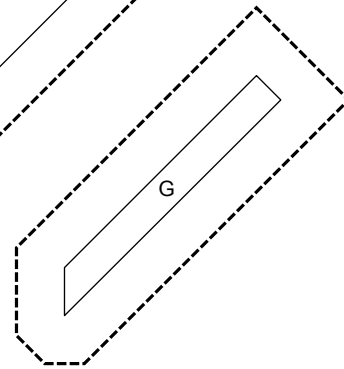
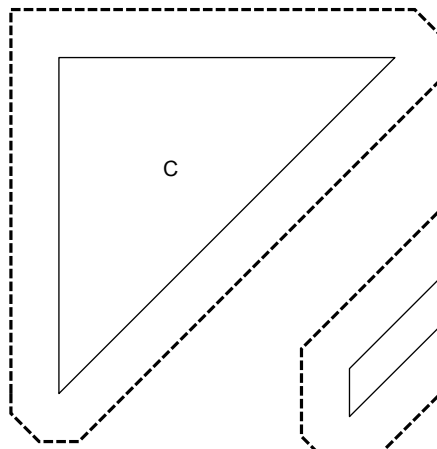
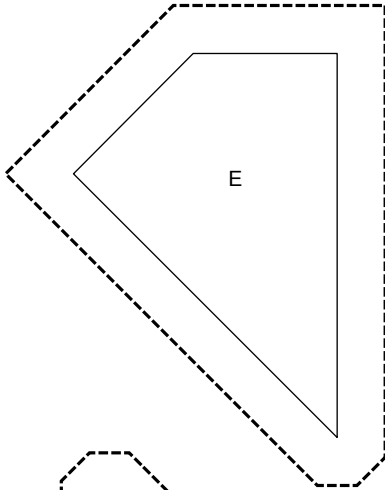
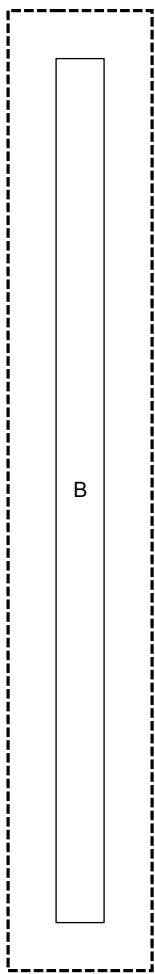
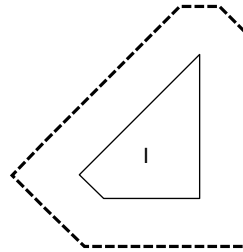
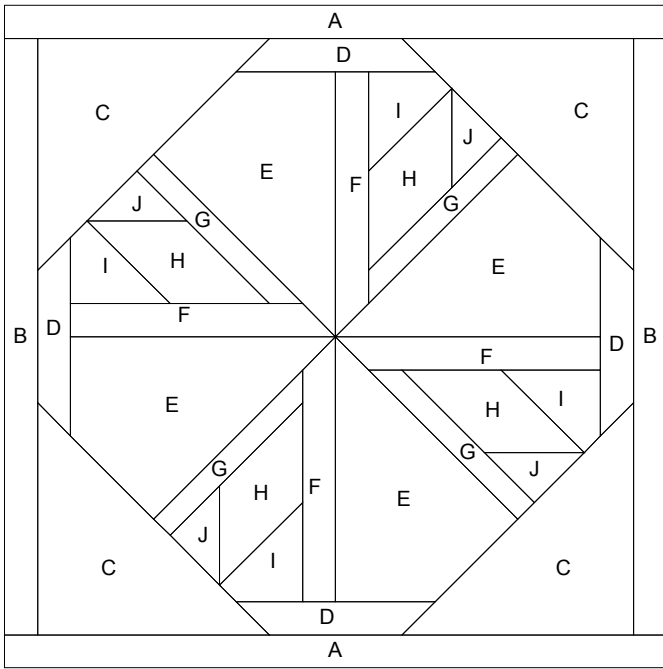

The Jane Stickle Quilt - Block H10



What you need:

Patches	Quantity/size
A*	(2) 1" x 6"
B*	(2) 1" x 5"
C	(2) 2⅜" x 2⅜" - navy (2) 2⅜" x 2⅜" - light blue
D	(4) 1⅝" x 2¾"
E	(1) 2" x 2" - light blue (1) 2" x 2" - green
F	(2) 1⅝" x 1⅝" - green

**The actual required width for Unit A and Unit B units is ¾". The increased width specified above allows for squaring the block to exactly 5½".*

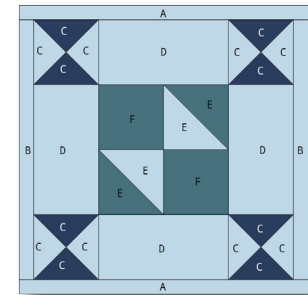

Hobbystash Colorway

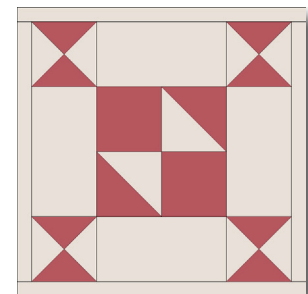

Jane Stickle Colorway

Assembly:

1. Referring to BASIC INSTRUCTIONS, make 2 HST units using the Unit E patches.
2. Assemble and sew together a four-patch unit using the Step 1 HST patches and two Unit F patches.
3. Referring to BASIC INSTRUCTIONS, make 4 HST units using the Unit C patches.
4. On the reverse side of one HST unit, draw a diagonal line from corner to corner opposite the seam. Align with second HST unit right sides together, with contrasting colors facing each other. Sew two seams, each 1/4" away from drawn line. Cut apart on the drawn line and press open. Repeat the process for a total of 4 quarter-square triangle (QST) units. The QST units should measure 1⅝" x 1⅝" square.
5. Sew a Step 4 QST to each side of two Unit D as shown. Sew the remaining two Unit D to each side Step 2 center patch as shown. Sew together the three rows.
6. Join Unit B to the right side of the block, and then the left.
7. Join Unit A to the top of the block and then the bottom. Square up block to measure 5½" x 5½" square.

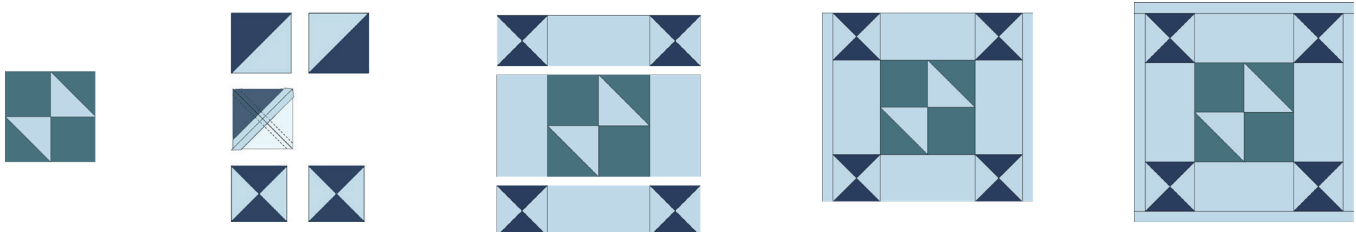

SET PRINTER TO "ACTUAL SIZE" WHEN PRINTING THIS PAGE.

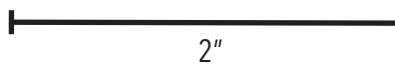
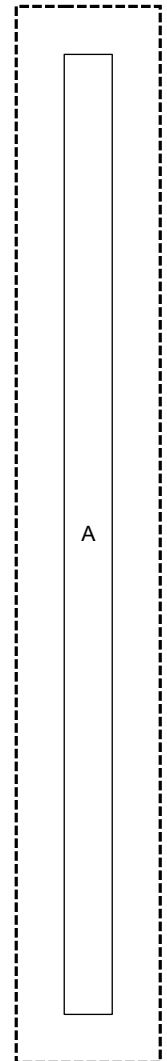
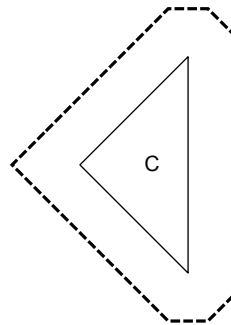
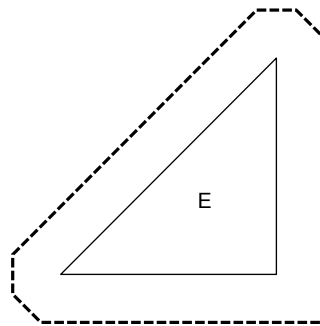
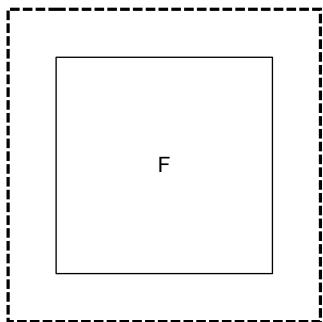
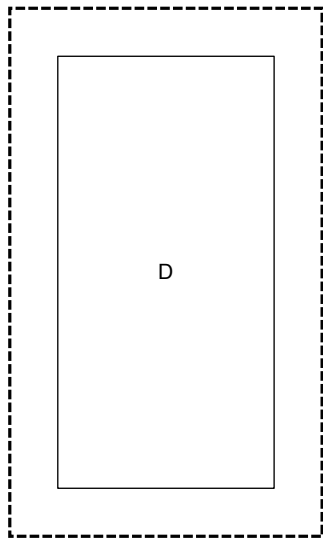
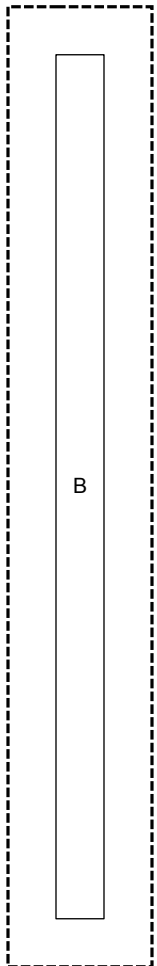
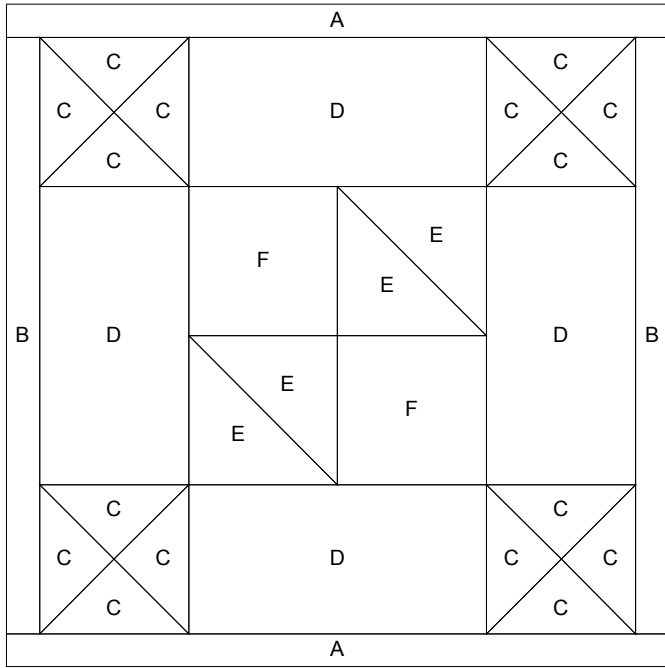

The Jane Stickle Quilt - Block H11

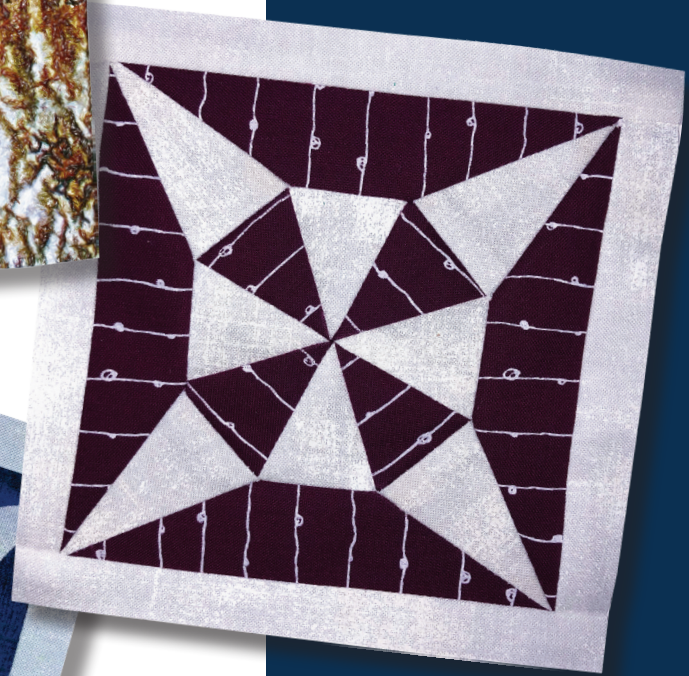
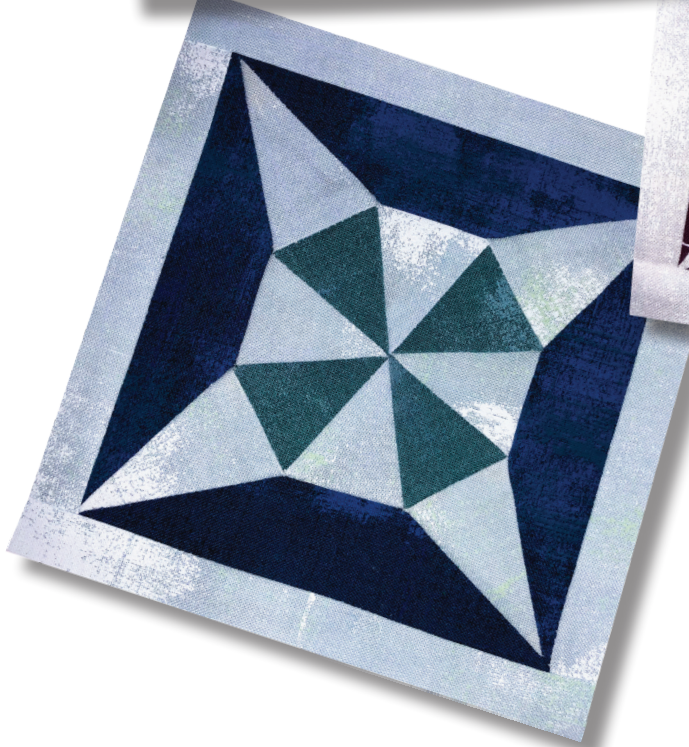

What you need:

Patches	Quantity/size
A*	(2) 1" x 6"
B*	(2) 1" x 5"
C	(4) 2" x 7"
D	(4) 2½" x 2½"
E	(4) 2½" x 2½"
F	(4) 2" x 3"

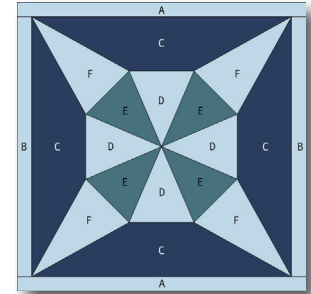

Hobbystash Colorway

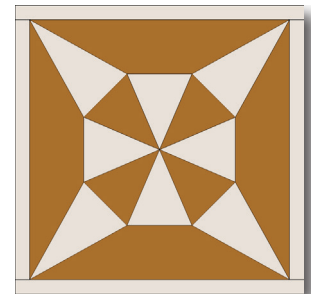

Jane Stickle Colorway

**The actual required width for Unit A and Unit B units is ¾". The increased width specified above allows for squaring the block to exactly 5½".*

Assembly:

1. Using templates on Page H11-2, foundation piece sections.
2. Assemble sections and sew together.
3. Join Unit B to the right side of the block, and then the left.
4. Join Unit A to the top of the block and then the bottom. Square up block to measure 5½" x 5½" square.



SET PRINTER TO "ACTUAL SIZE" WHEN PRINTING THIS PAGE.

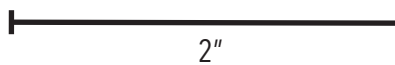
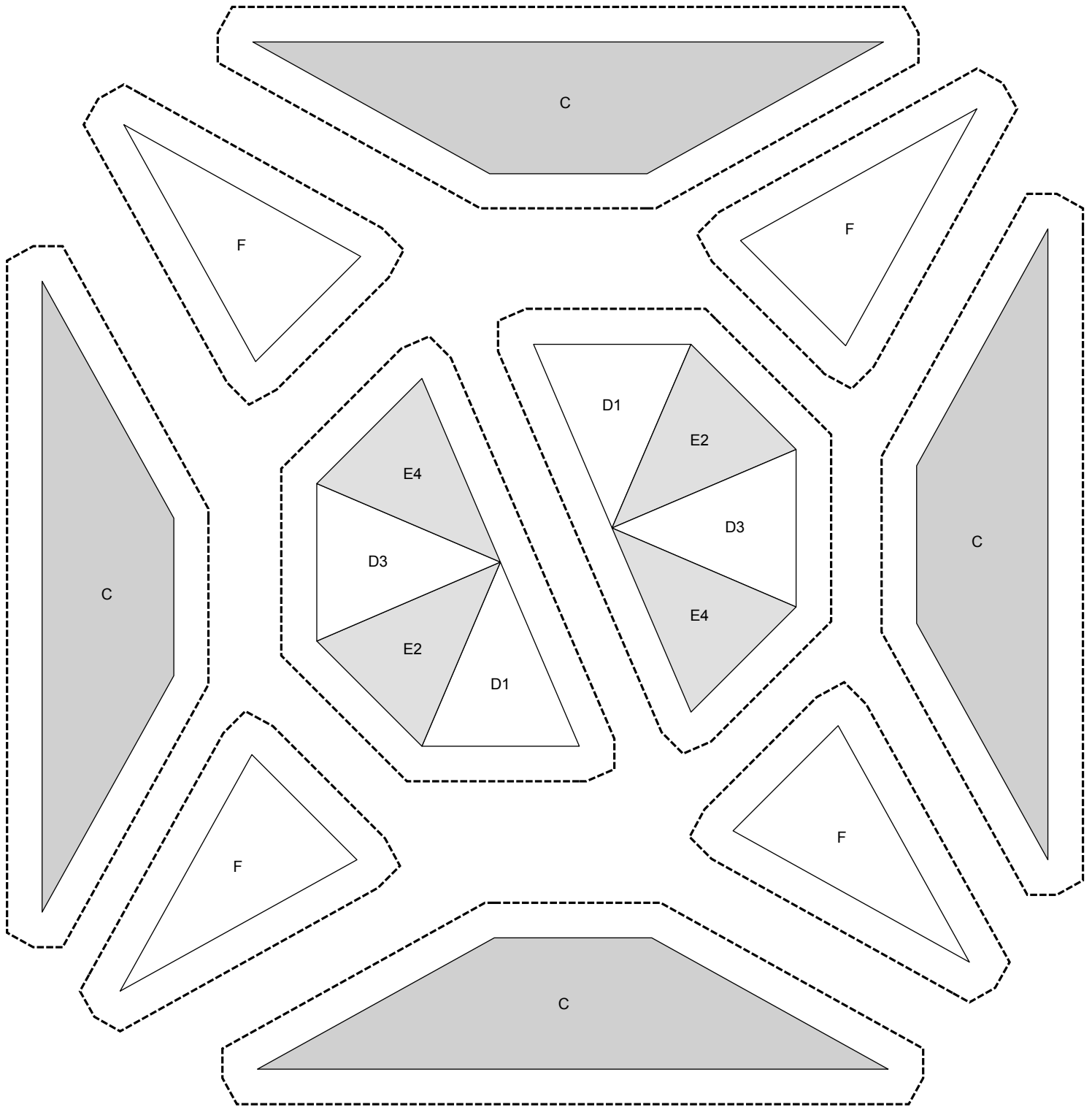

SET PRINTER TO "ACTUAL SIZE" WHEN PRINTING THIS PAGE.

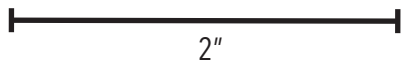
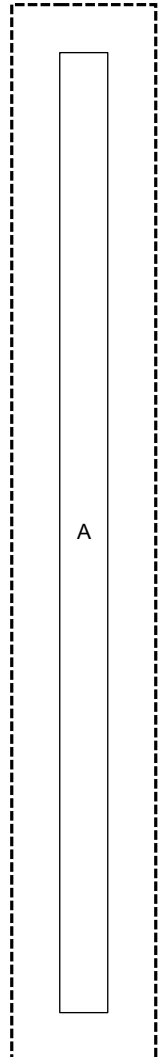
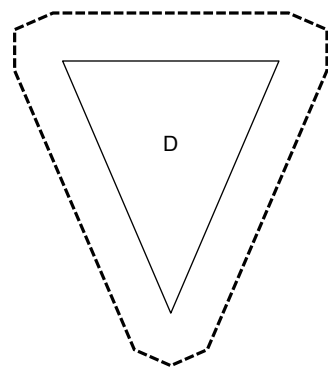
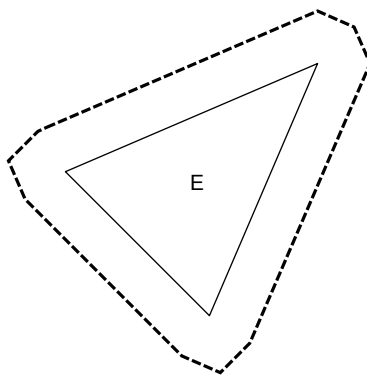
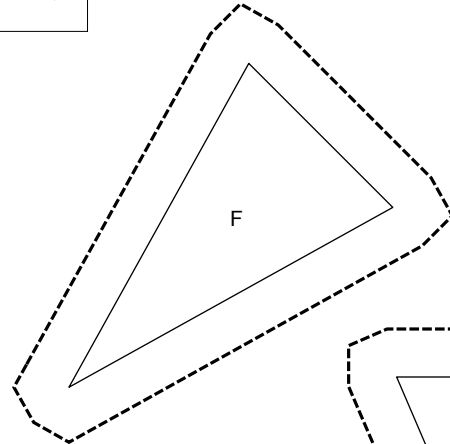
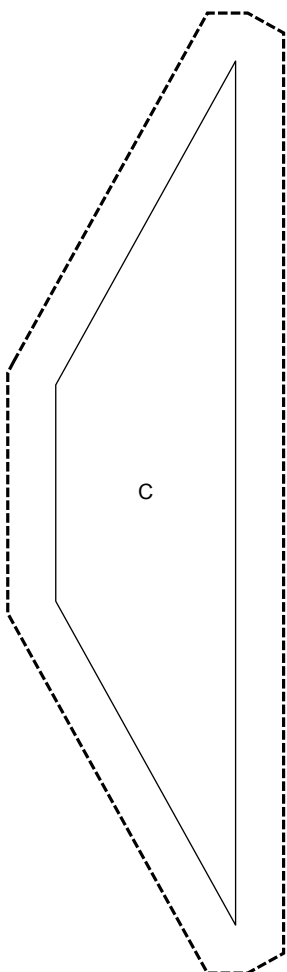
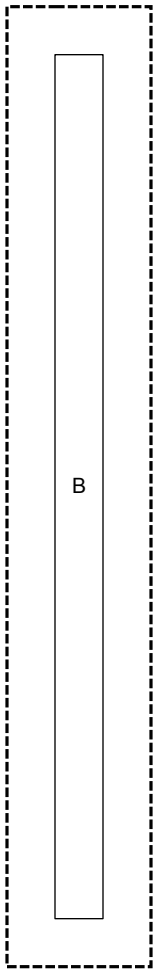
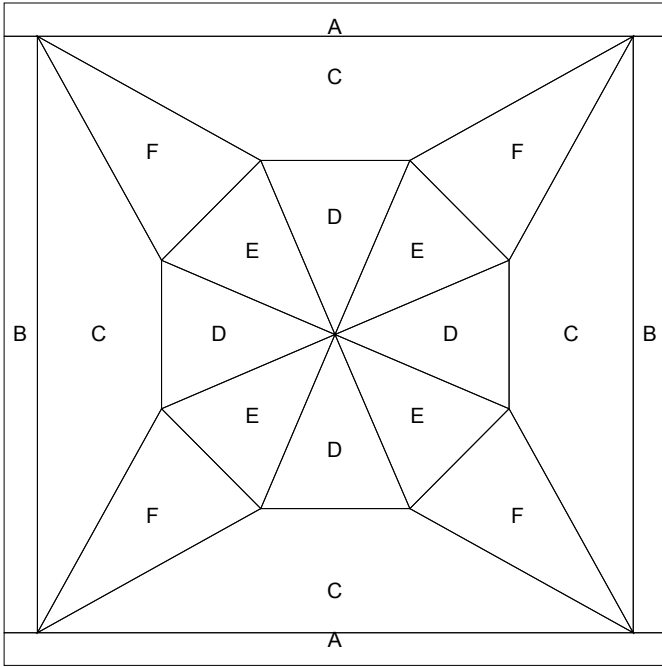

The Jane Stickle Quilt - Block H12

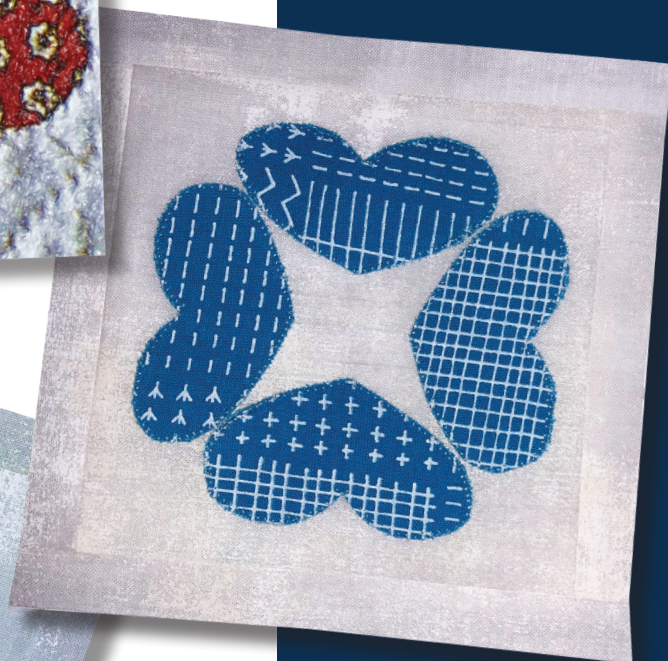

What you need:

Patches	Quantity/size
A*	(2) 1" x 6"
B*	(2) 1" x 5"
C	(1) 6" x 6"
D	(4) 2½" x 3½"

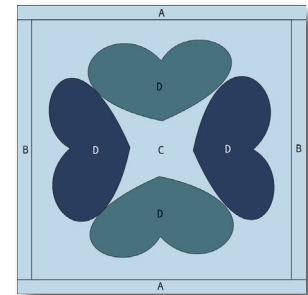

Hobbystash Colorway

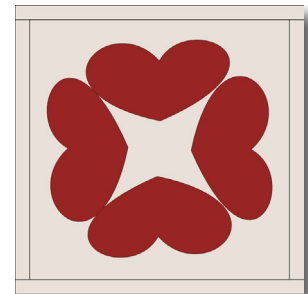

Jane Stickle Colorway

**The actual required width for Unit A and Unit B units is ¾". The increased width specified above allows for squaring the block to exactly 5½".*

Assembly:

1. Using heart template on Page H12-2, appliqué four hearts to Unit C as shown. Square block to 5" x 5" square.
2. Join Unit B to the right side of the block, and then the left.
3. Join Unit A to the top of the block and then the bottom. Square up block to measure 5½" x 5½" square.

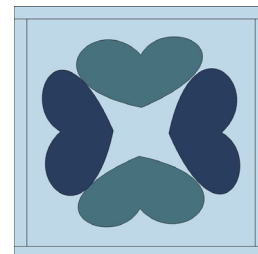
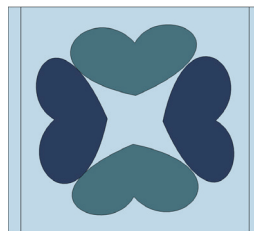
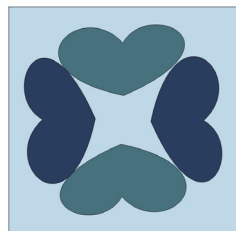

SET PRINTER TO "ACTUAL SIZE" WHEN PRINTING THIS PAGE.

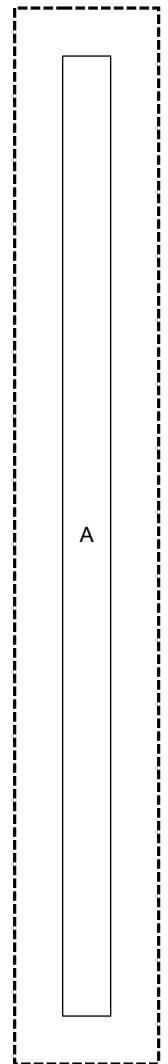
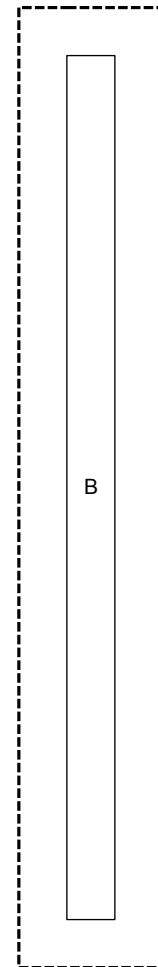
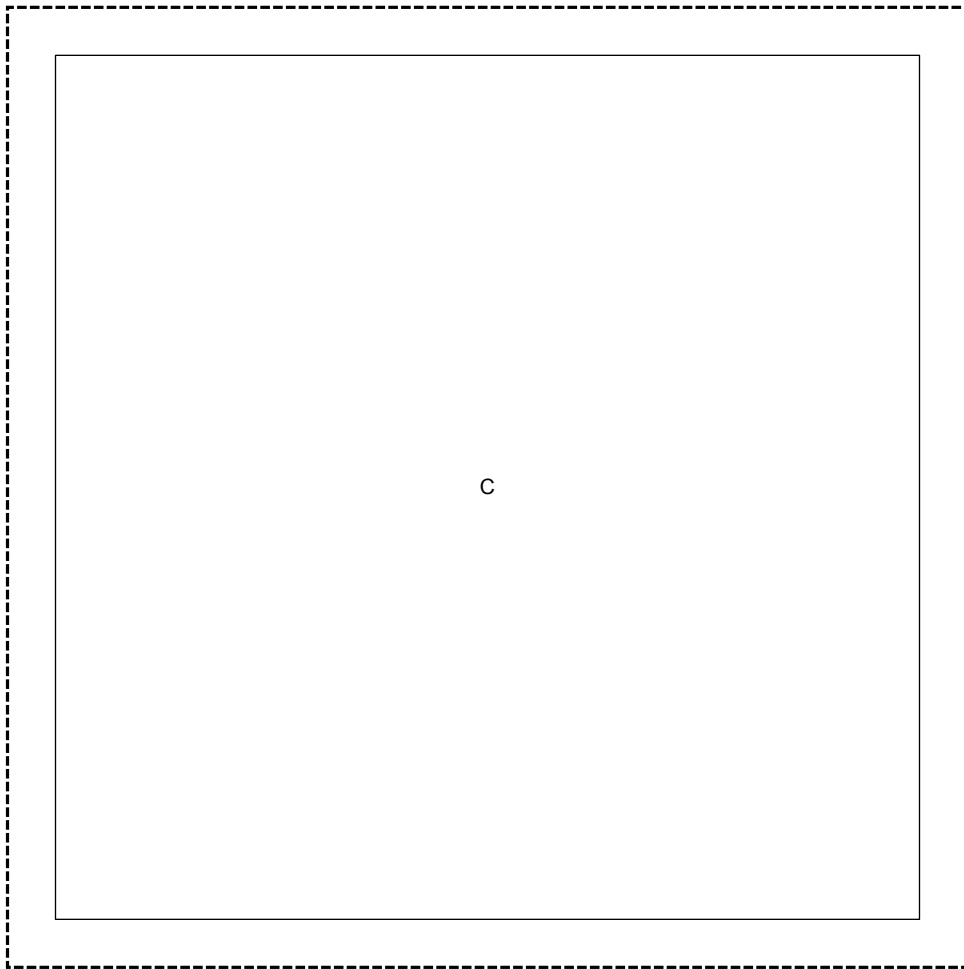
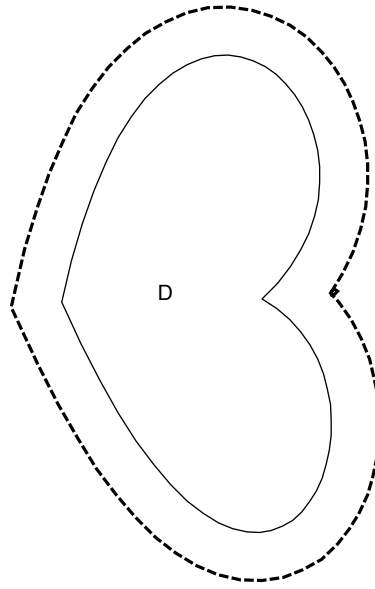
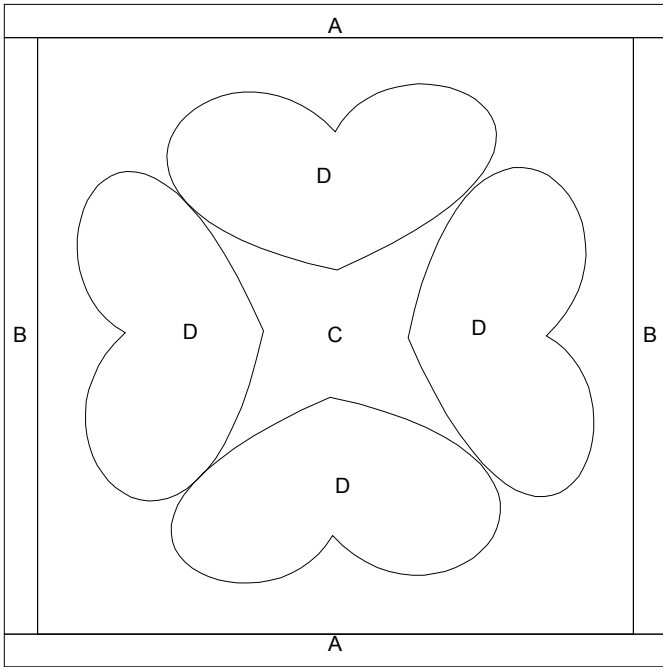

2"

The Jane Stickle Quilt - Block H13

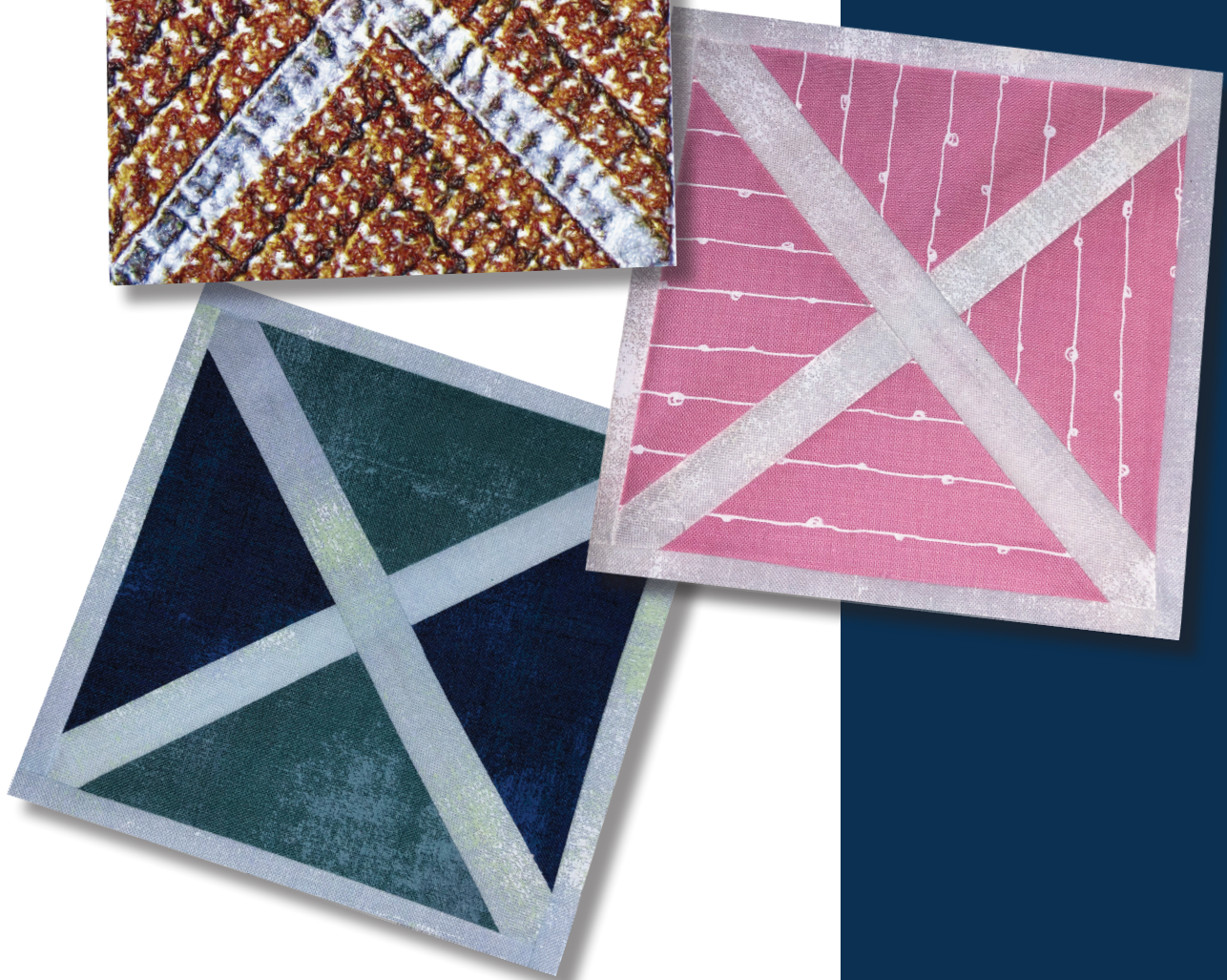
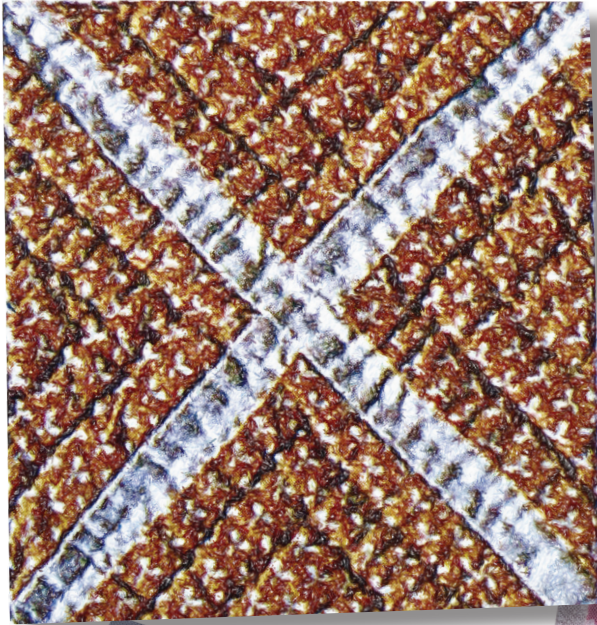

What you need:

Patches	Quantity/size
A*	(2) 1" x 6"
B*	(2) 1" x 5"
C	(1) 1½" x 7½"
D	(1) 5½" x 5½" - green, cut twice diagonally (1) 5½" x 5½" - navy, cut twice diagonally
E	(2) 1½" x 4"

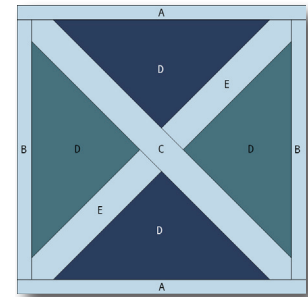

Hobbystash Colorway

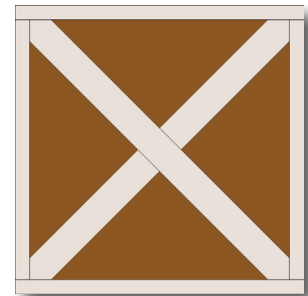

Jane Stickle Colorway

**The actual required width for Unit A and Unit B units is ¾". The increased width specified above allows for squaring the block to exactly 5½".*

Assembly:

1. Using templates on Page H13-2, foundation piece sections.
2. Assemble sections and sew together.
3. Join Unit B to the right side of the block, and then the left.
4. Join Unit A to the top of the block and then the bottom. Square up block to measure 5½" x 5½" square.

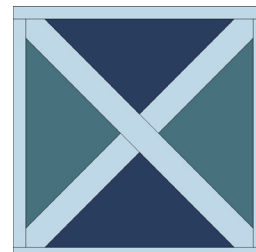
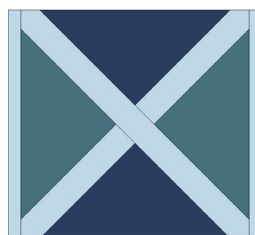

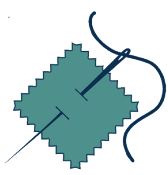

SET PRINTER TO "ACTUAL SIZE" WHEN PRINTING THIS PAGE.

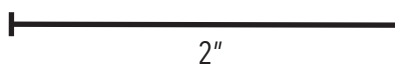
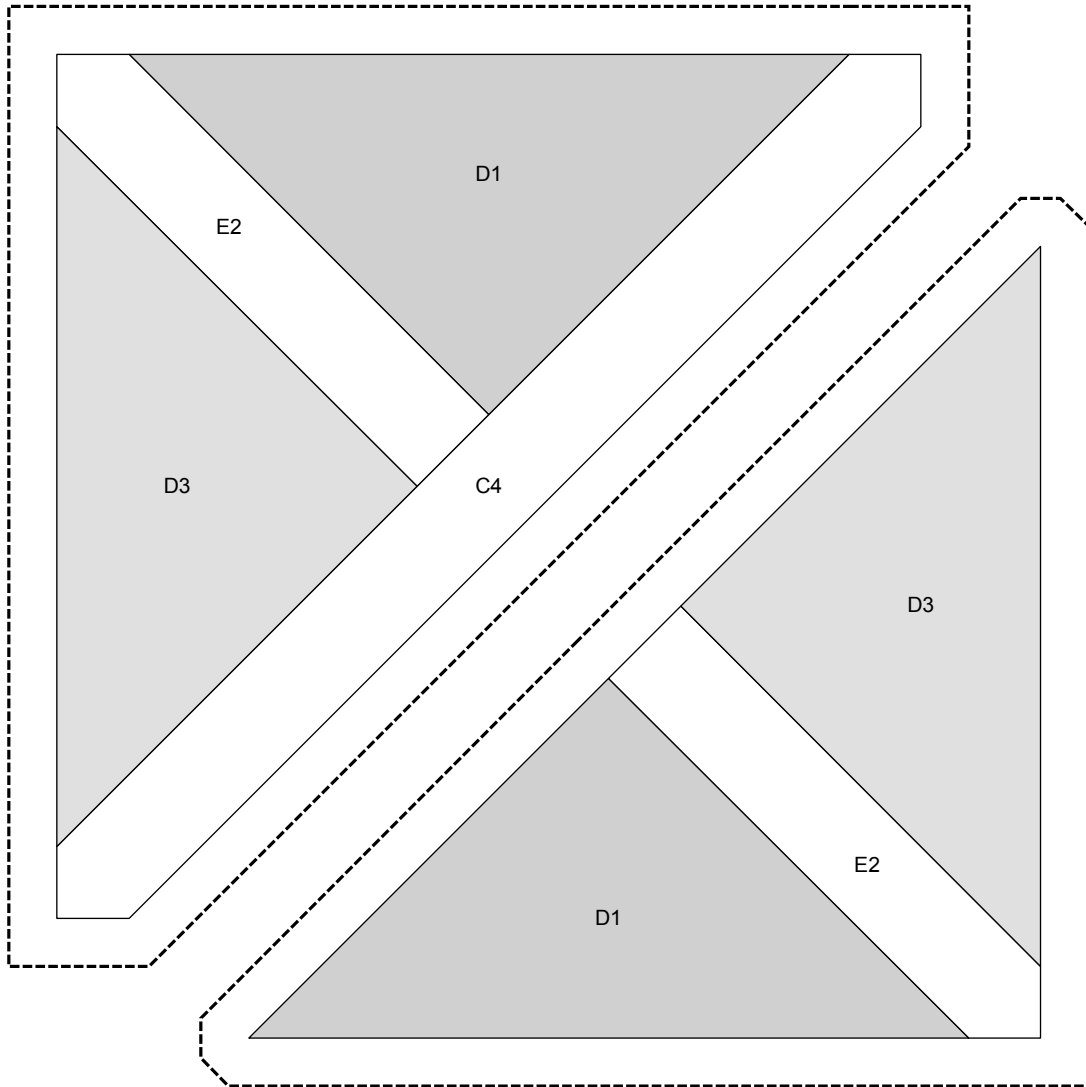

SET PRINTER TO "ACTUAL SIZE" WHEN PRINTING THIS PAGE.

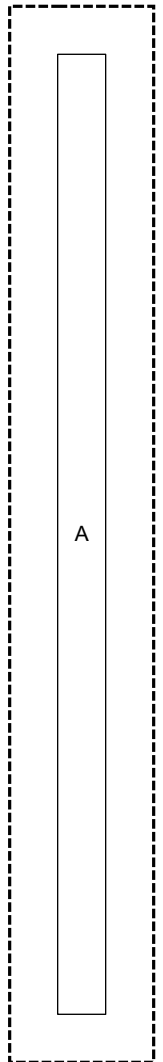
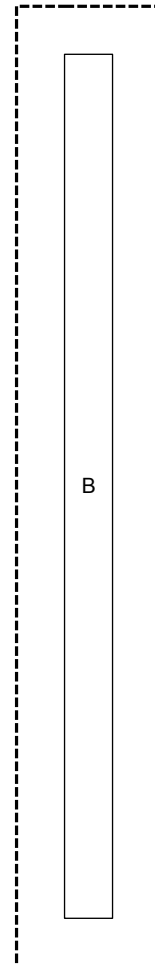
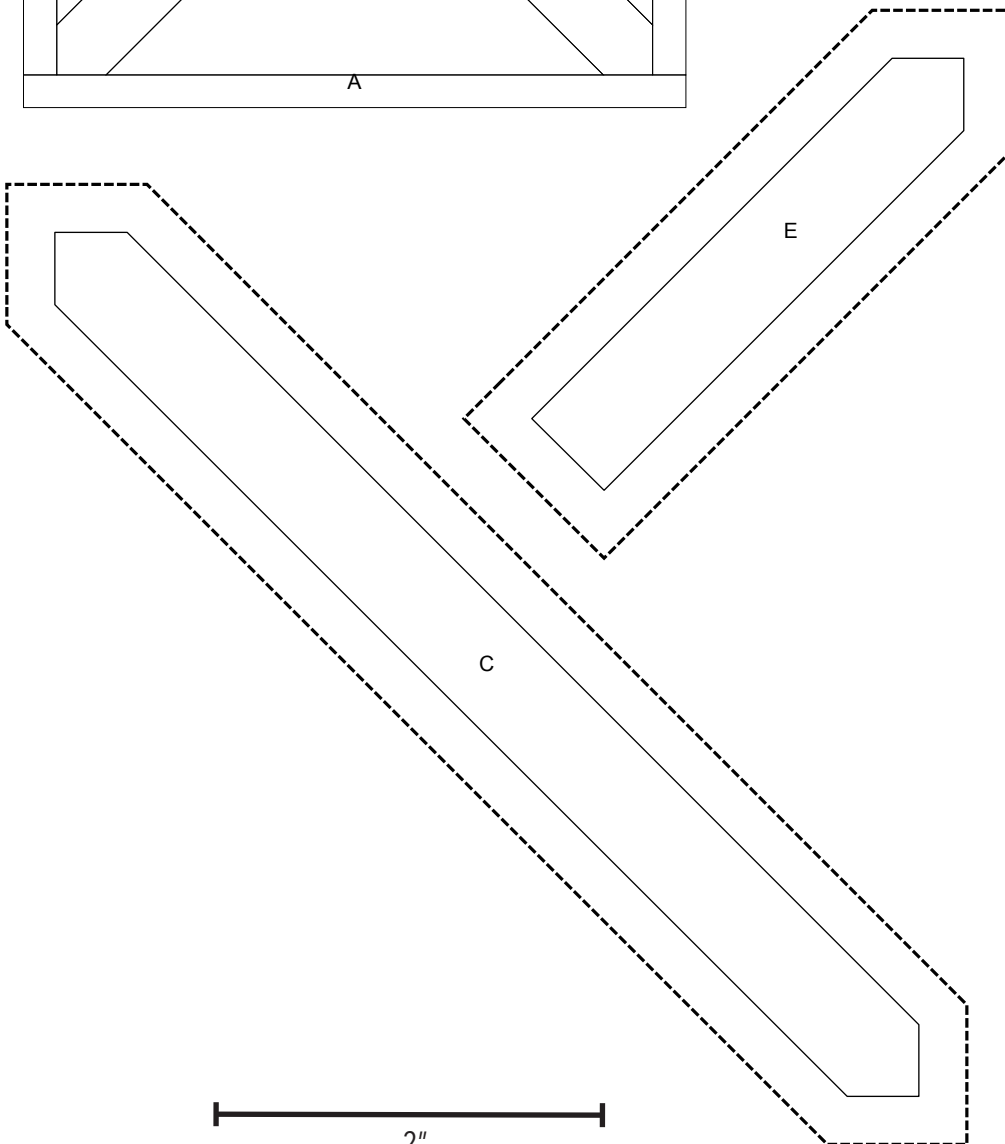
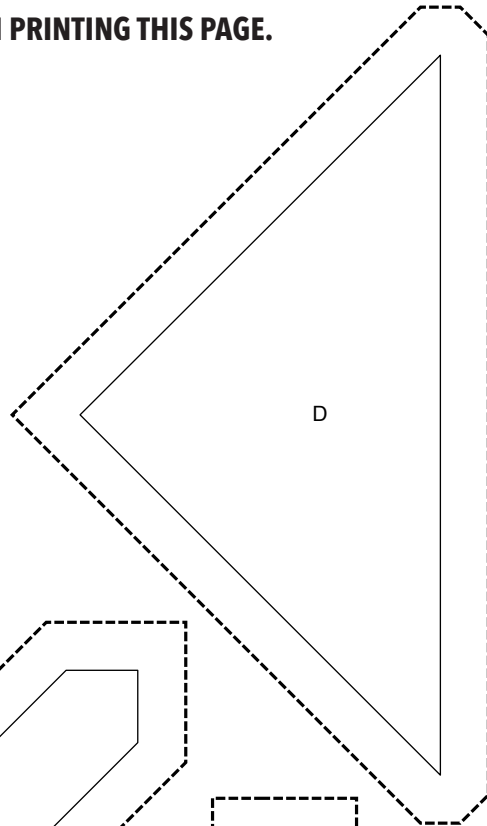
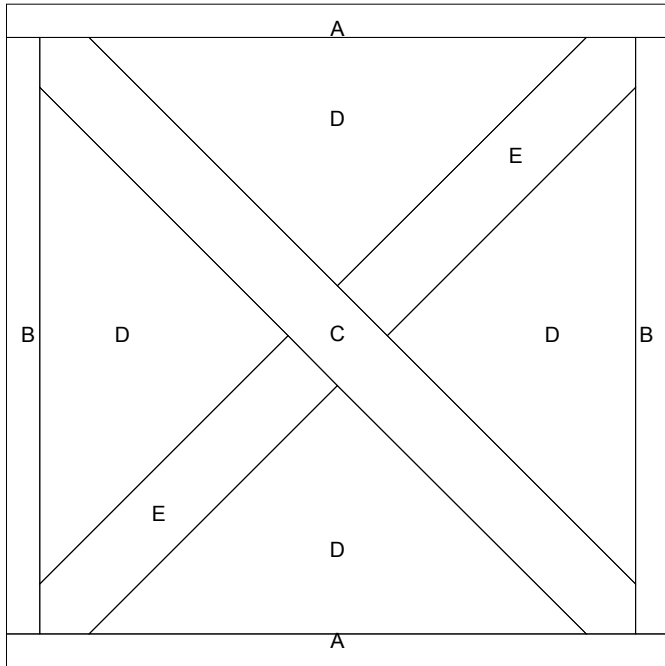

2"