

## The Jane Stickle Quilt - Row G

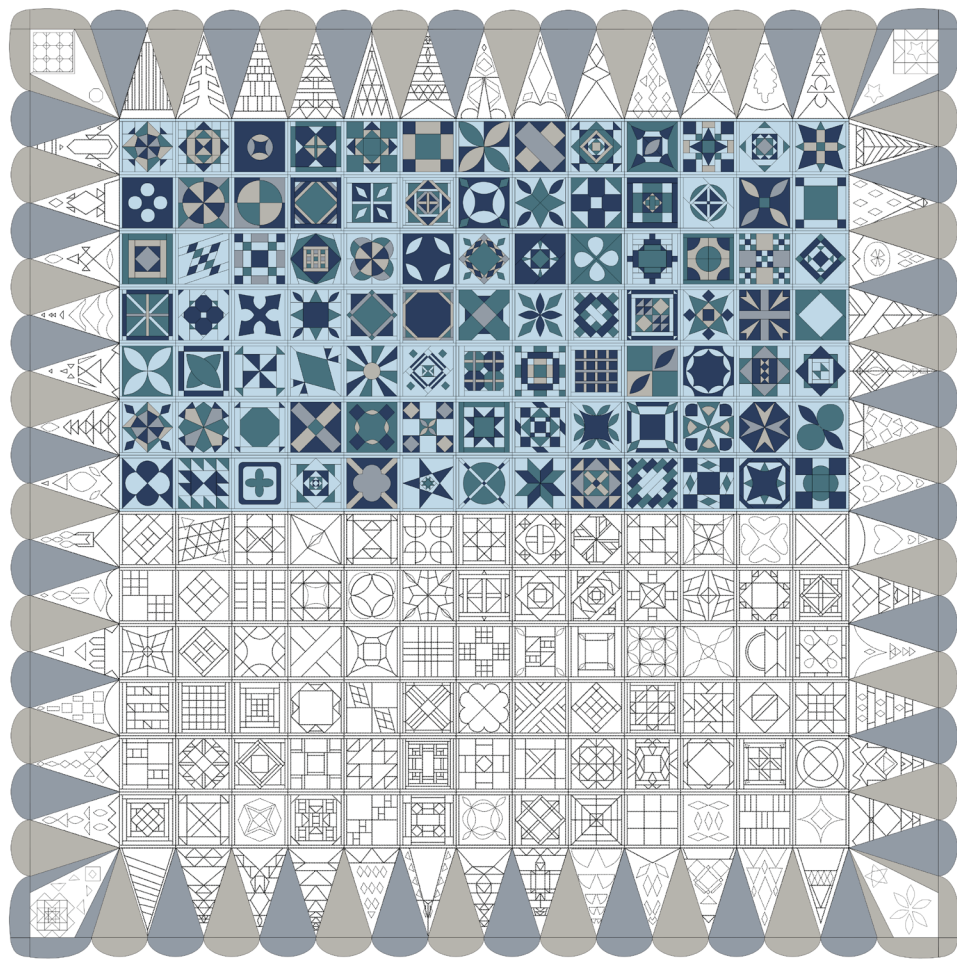

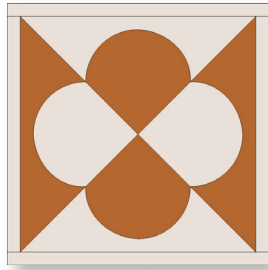

G1

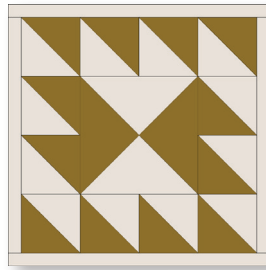

G2

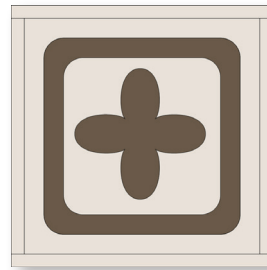

G3

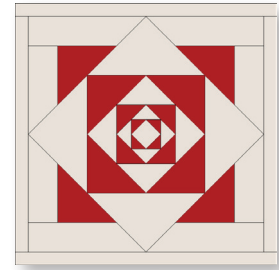

G4

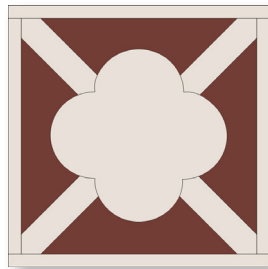

G5

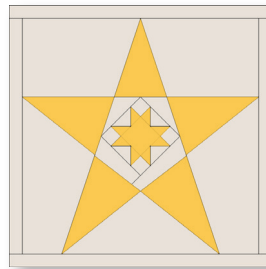

G6

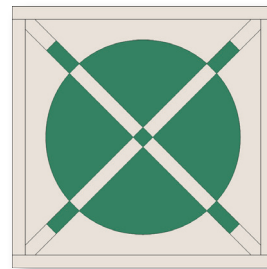

G7

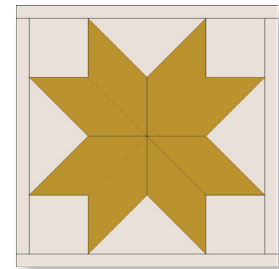

G8

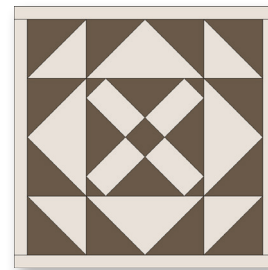

G9

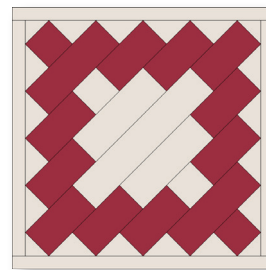

G10

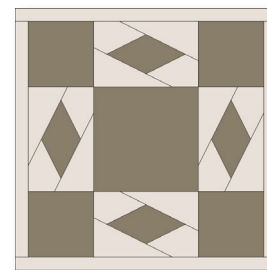

G11

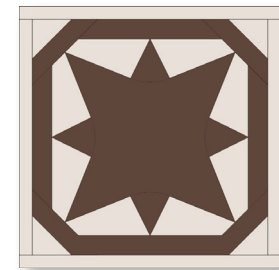

G12

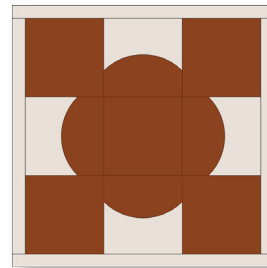

G13

## The Jane Stickle Quilt - Block G1

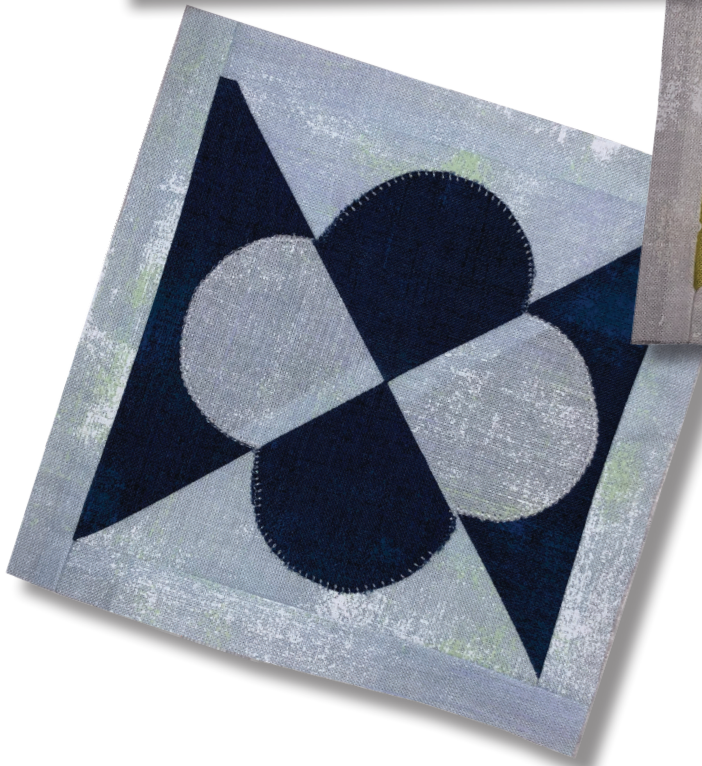

### What you need:

Patches	Quantity/size
A*	(2) 1" x 6"
B*	(2) 1" x 5"
C 	(1) 6" x 6" - navy, cut twice diagonally (1) 6" x 6" - lt blue, cut twice diagonally
D	Use remaining triangles from C

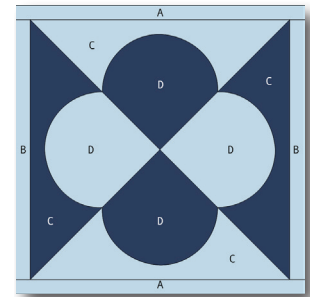

*Hobbystash Colorway*

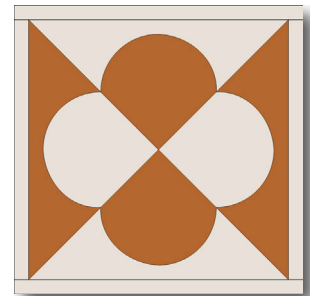

*Jane Stickle Colorway*

*\*The actual required width for Unit A and Unit B units is ¾". The increased width specified above allows for squaring the block to exactly 5½".*

### Assembly:

- Using templates on Page G1-2 and G1-3, foundation piece sections.
- Assemble sections and sew together to make 2 quarter square triangle (QST) blocks.
- Using the template provided on Page G1-4, cut clover shape from one of the QST blocks. Appliqué cut clover to remaining QST block as shown.
- Join Unit B to the right side of the block, and then the left.
- Join Unit A to the top of the block and then the bottom. Square up block to measure 5½" x 5½" square.

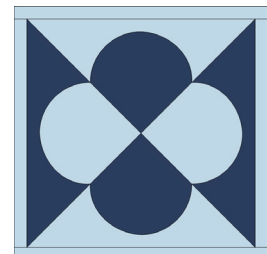
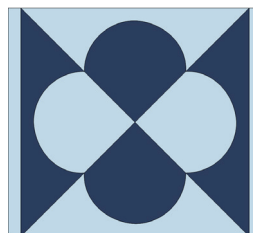
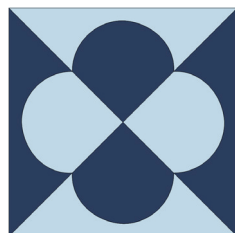
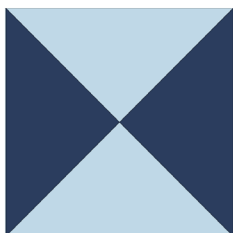

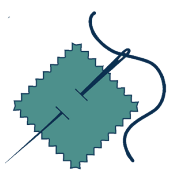

SET PRINTER TO "ACTUAL SIZE" WHEN PRINTING THIS PAGE.

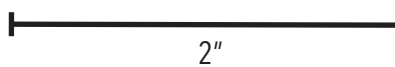
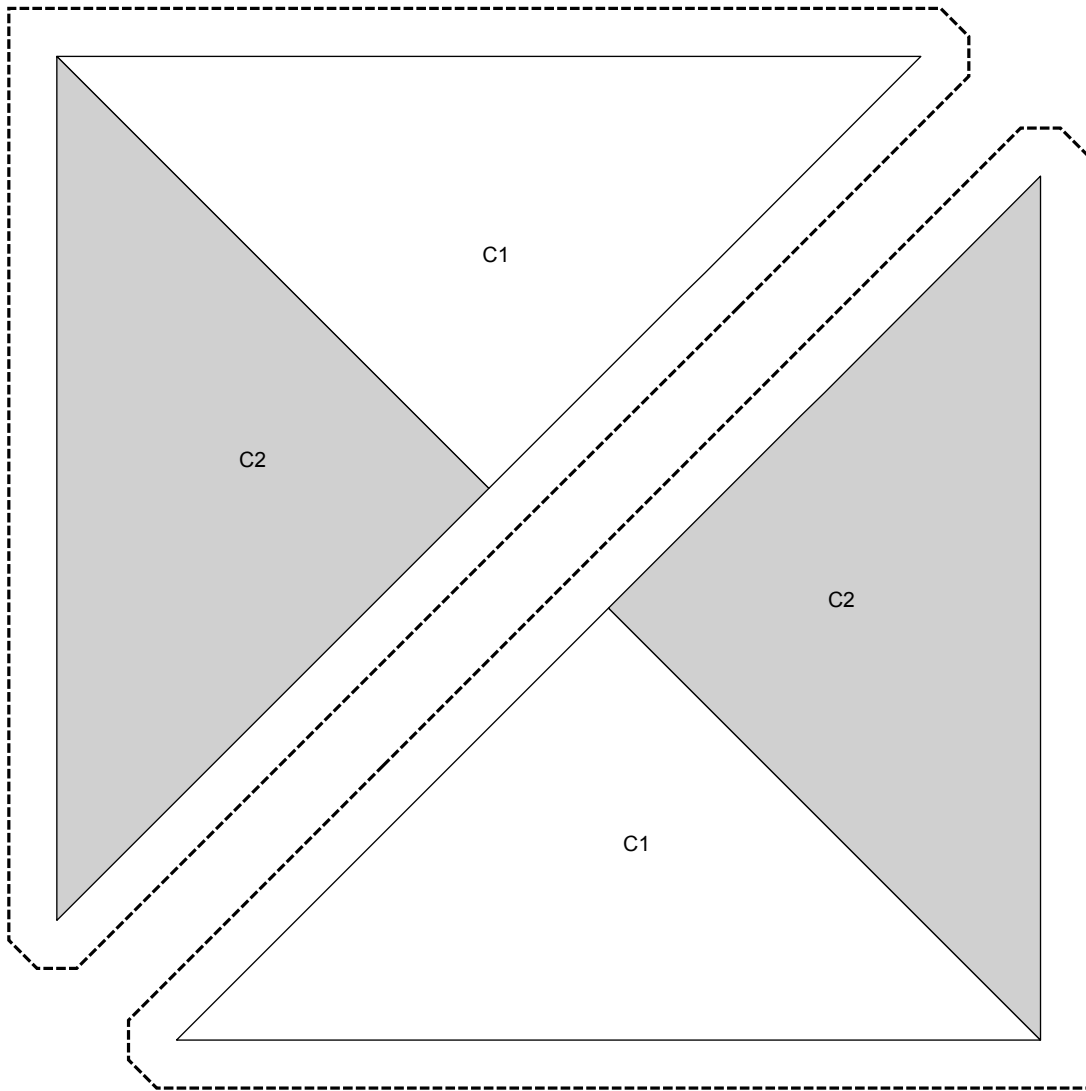

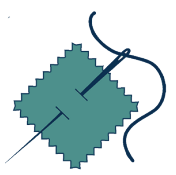

SET PRINTER TO "ACTUAL SIZE" WHEN PRINTING THIS PAGE.

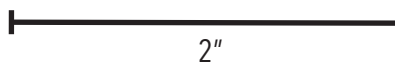
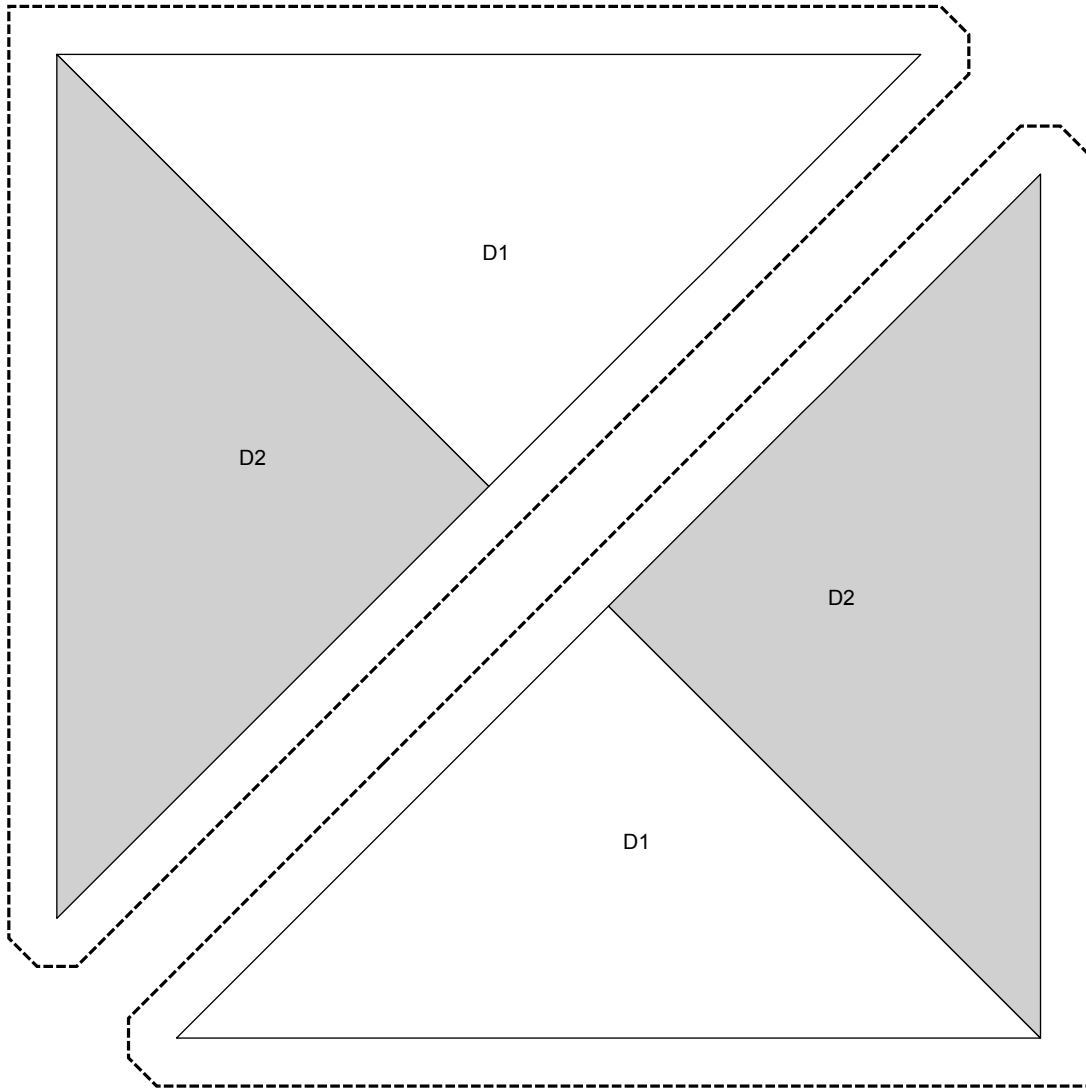

SET PRINTER TO "ACTUAL SIZE" WHEN PRINTING THIS PAGE.

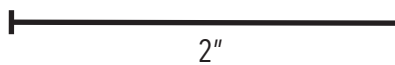
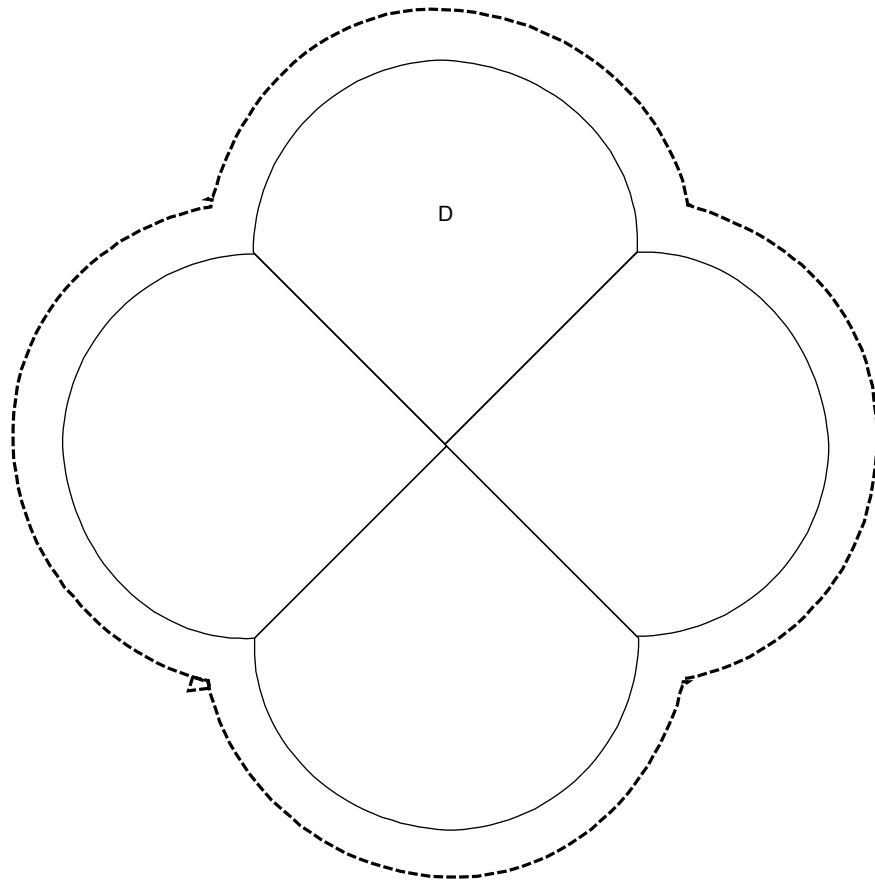

SET PRINTER TO "ACTUAL SIZE" WHEN PRINTING THIS PAGE.

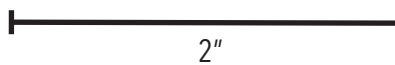
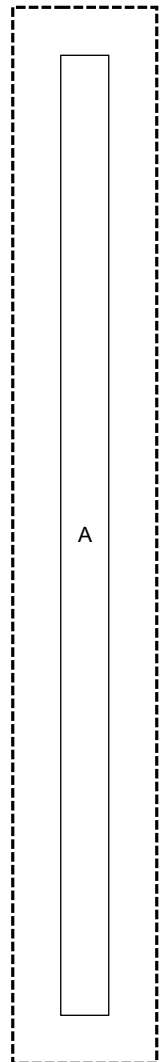
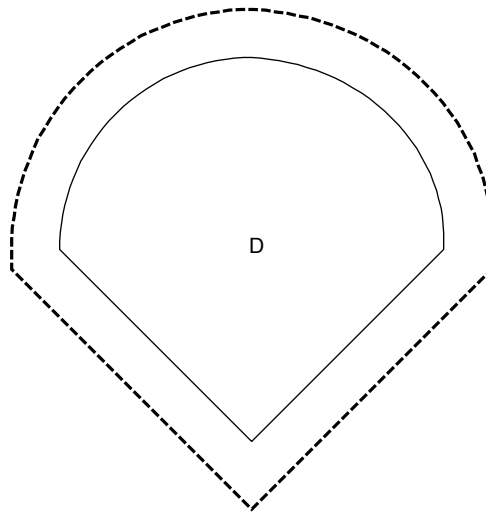
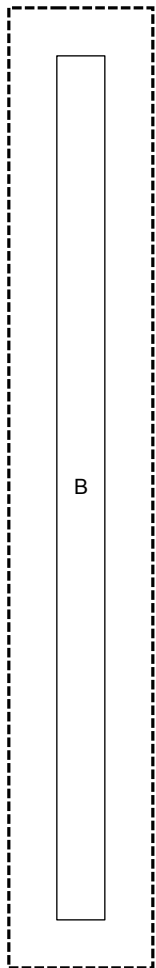
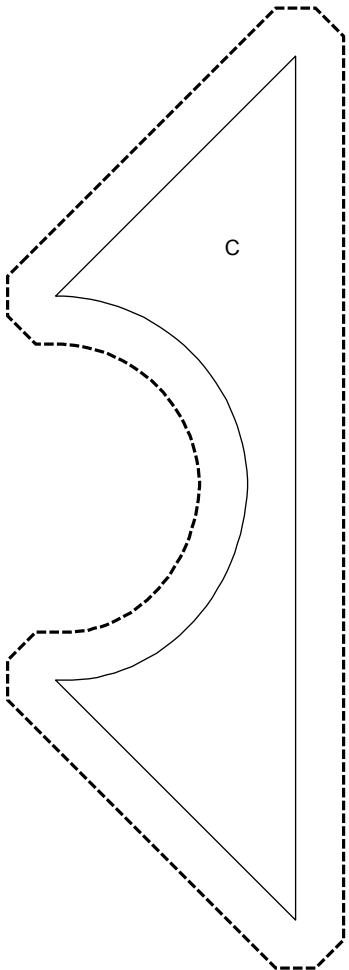
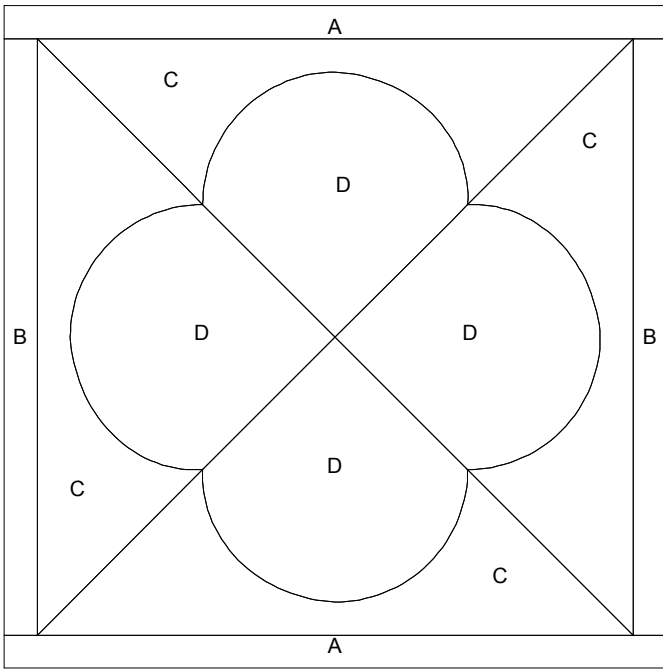





## The Jane Stickle Quilt - Block G2



### What you need:

Patches	Quantity/size
A*	(2) 1" x 6"
B*	(2) 1" x 5"
C 	(2) 2½" x 2½" - navy, cut once diagonally (6) 2½" x 2½" - lt blue, cut once diagonally (4) 2½" x 2½" - green, cut once diagonally
D 	(1) 4" x 4" - navy, cut twice diagonally (1) 4" x 4" - lt blue, cut twice diagonally

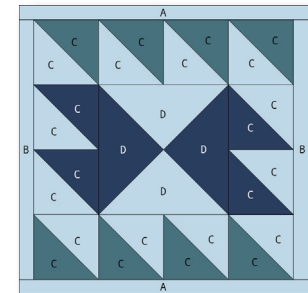

Hobby Stash Colorway

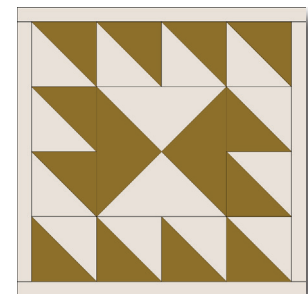

Jane Stickle Colorway

*\*The actual required width for Unit A and Unit B units is ¾". The increased width specified above allows for squaring the block to exactly 5½".*

### Assembly:

1. Using templates on Page G2-2, foundation piece sections.
2. Assemble sections and sew together.
3. Join Unit B to the right side of the block, and then the left.
4. Join Unit A to the top of the block and then the bottom. Square up block to measure 5½" x 5½" square.

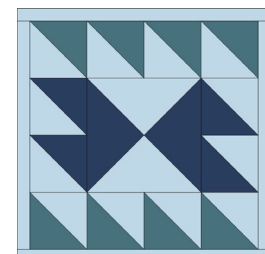
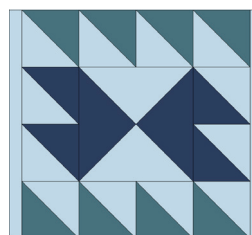
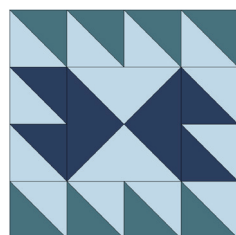
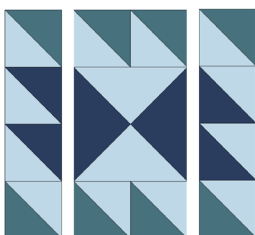

SET PRINTER TO "ACTUAL SIZE" WHEN PRINTING THIS PAGE.

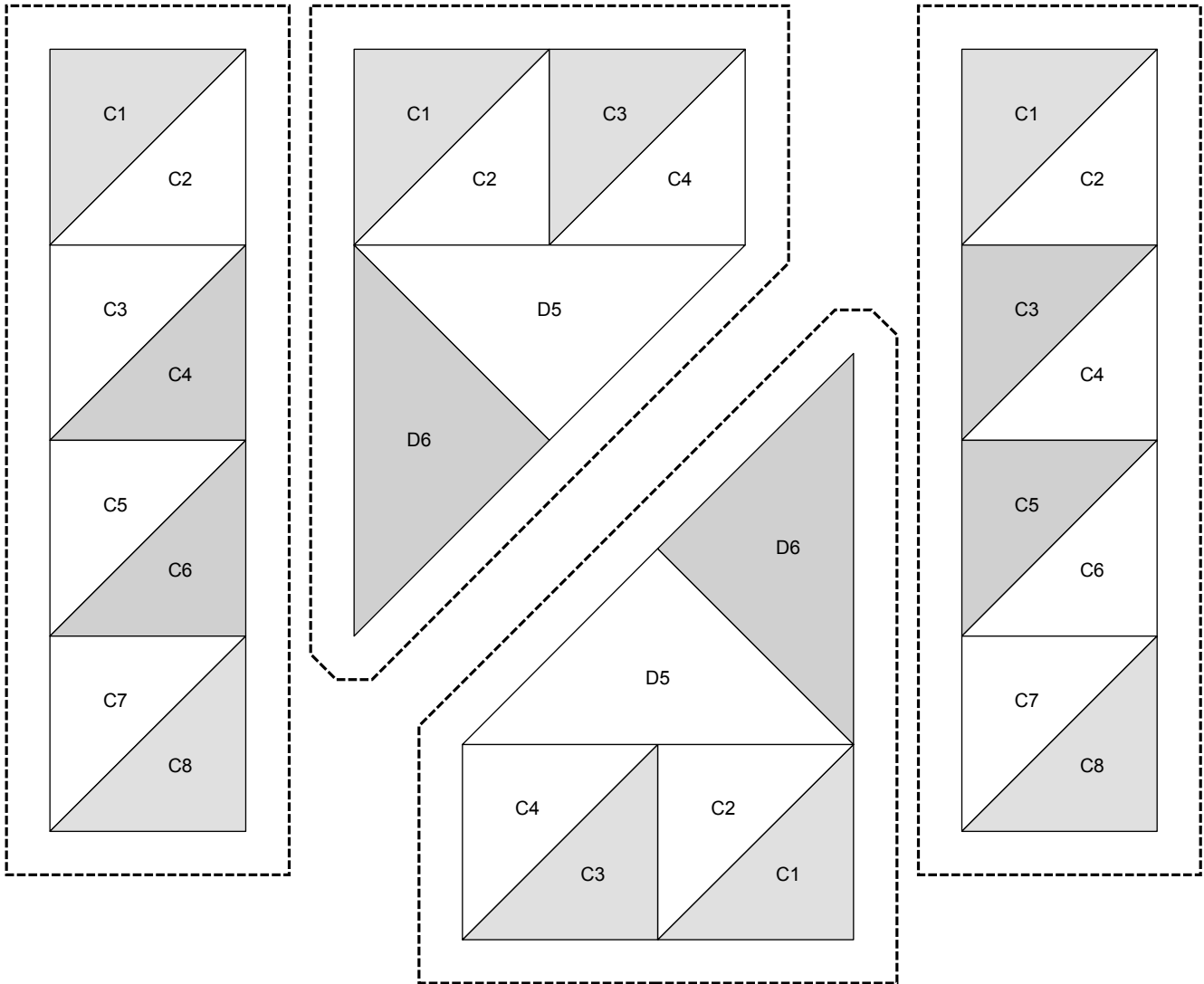

2"

SET PRINTER TO "ACTUAL SIZE" WHEN PRINTING THIS PAGE.

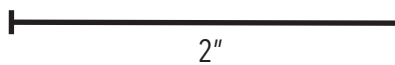
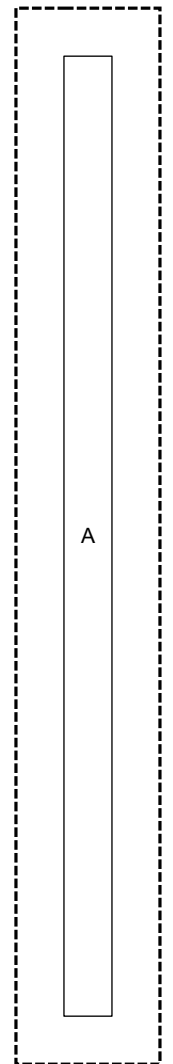
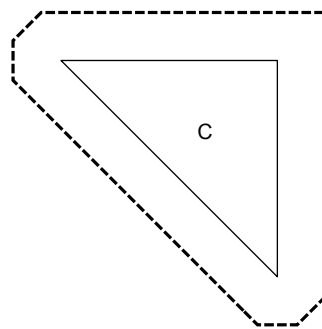
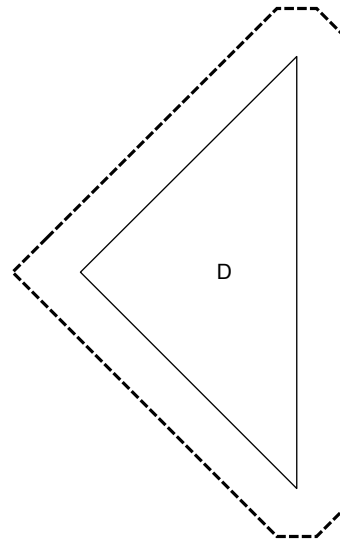
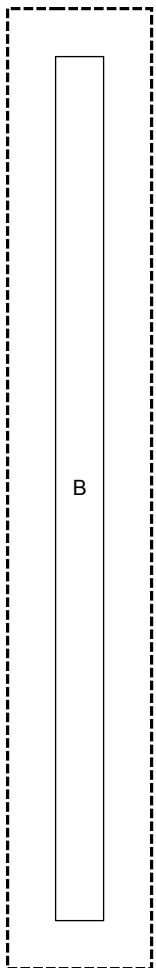
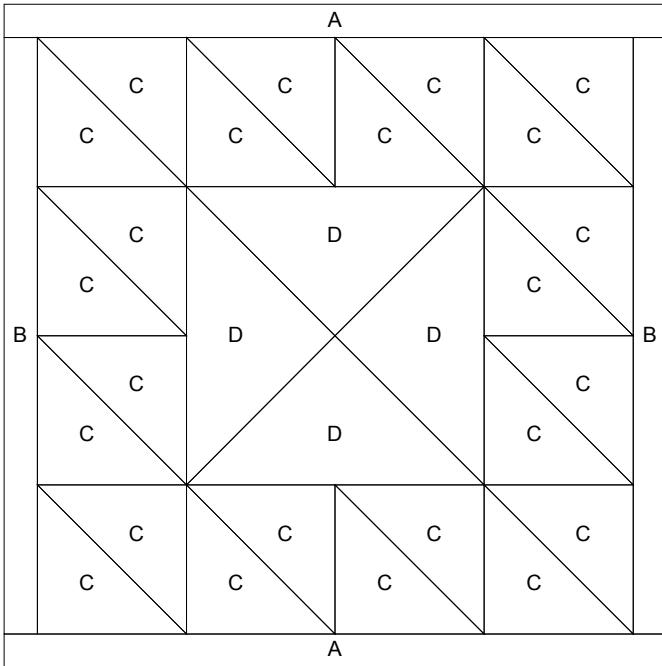

## The Jane Stickle Quilt - Block G3



### What you need:

Patches	Quantity/size
A*	(2) 1" x 6"
B*	(2) 1" x 5"
C	(1) 6" x 6"
D/E	(1) 5" x 5"
F	(1) 3" x 3"

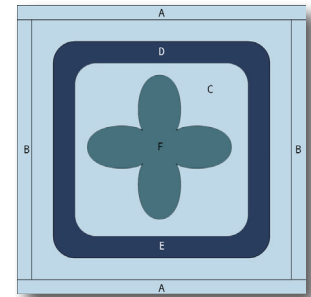

Hobbystash Colorway

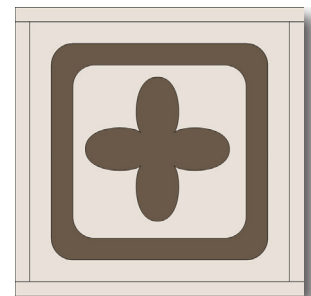

Jane Stickle Colorway

\*The actual required width for Unit A and Unit B units is ¾". The increased width specified above allows for squaring the block to exactly 5½".

\*\* If you are making the center background the same color as the outer background, Unit F can be eliminated.

### Assembly:

1. Using templates on Page G3-2 appliqué Unit D/E to Unit C.
2. Using template on G3-2, appliqué Unit F clover to center of Step 1 patch. Square block to 5" x 5" square.
3. Join Unit B to the right side of the block, and then the left.
4. Join Unit A to the top of the block and then the bottom. Square up block to measure 5½" x 5½" square.

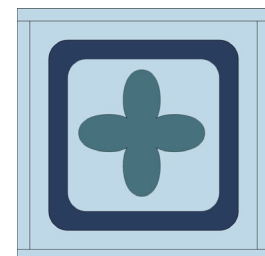
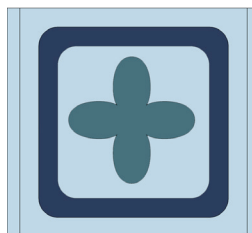
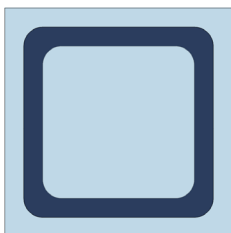

SET PRINTER TO "ACTUAL SIZE" WHEN PRINTING THIS PAGE.

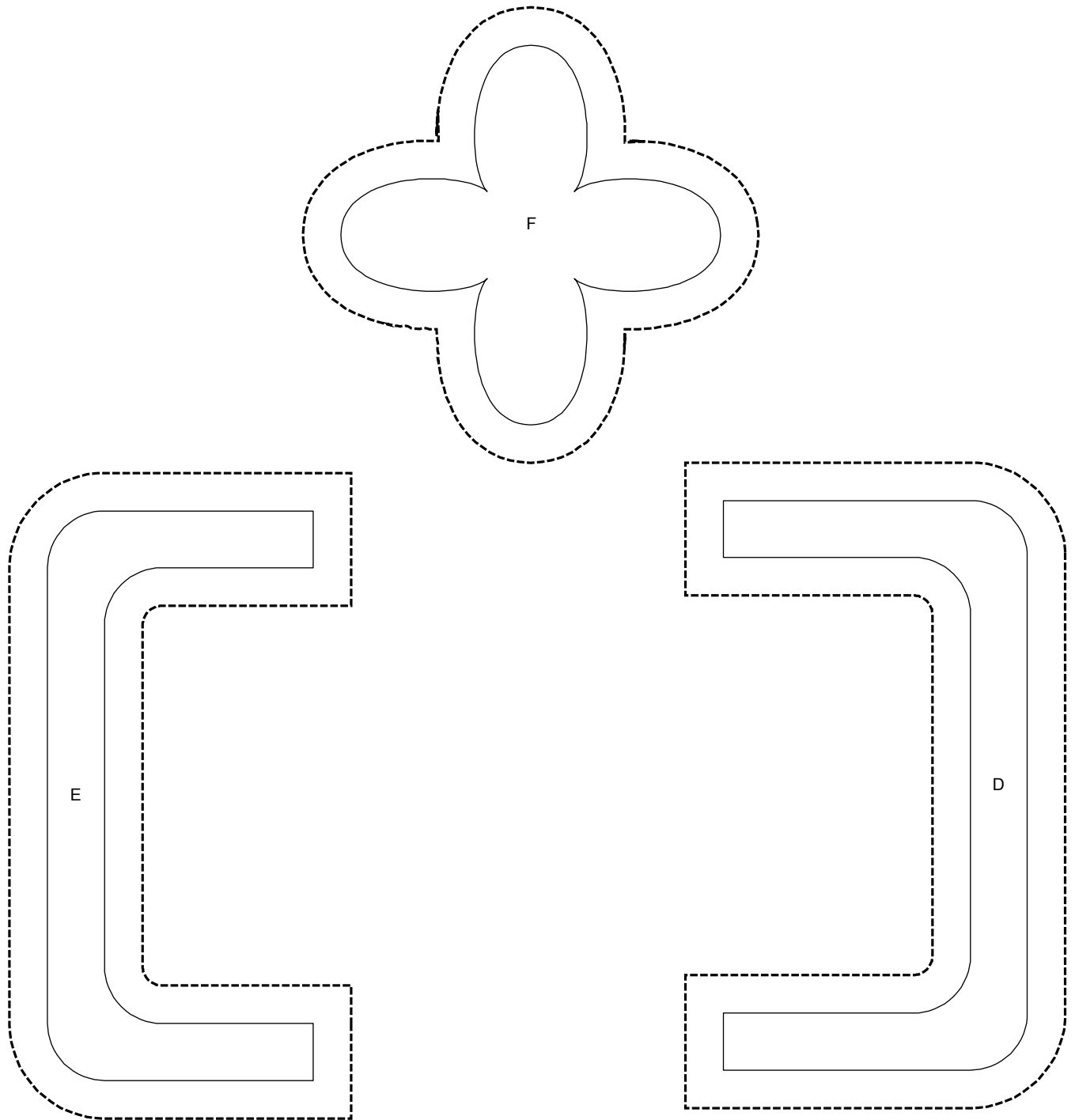

SET PRINTER TO "ACTUAL SIZE" WHEN PRINTING THIS PAGE.

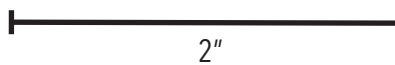
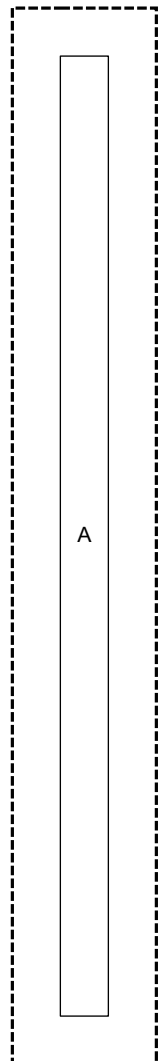
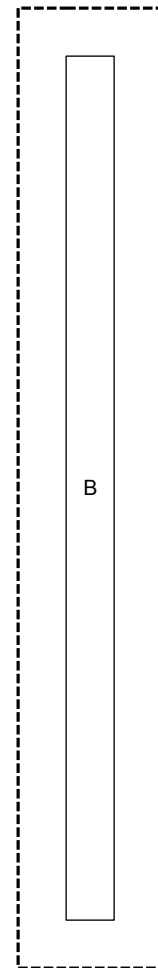
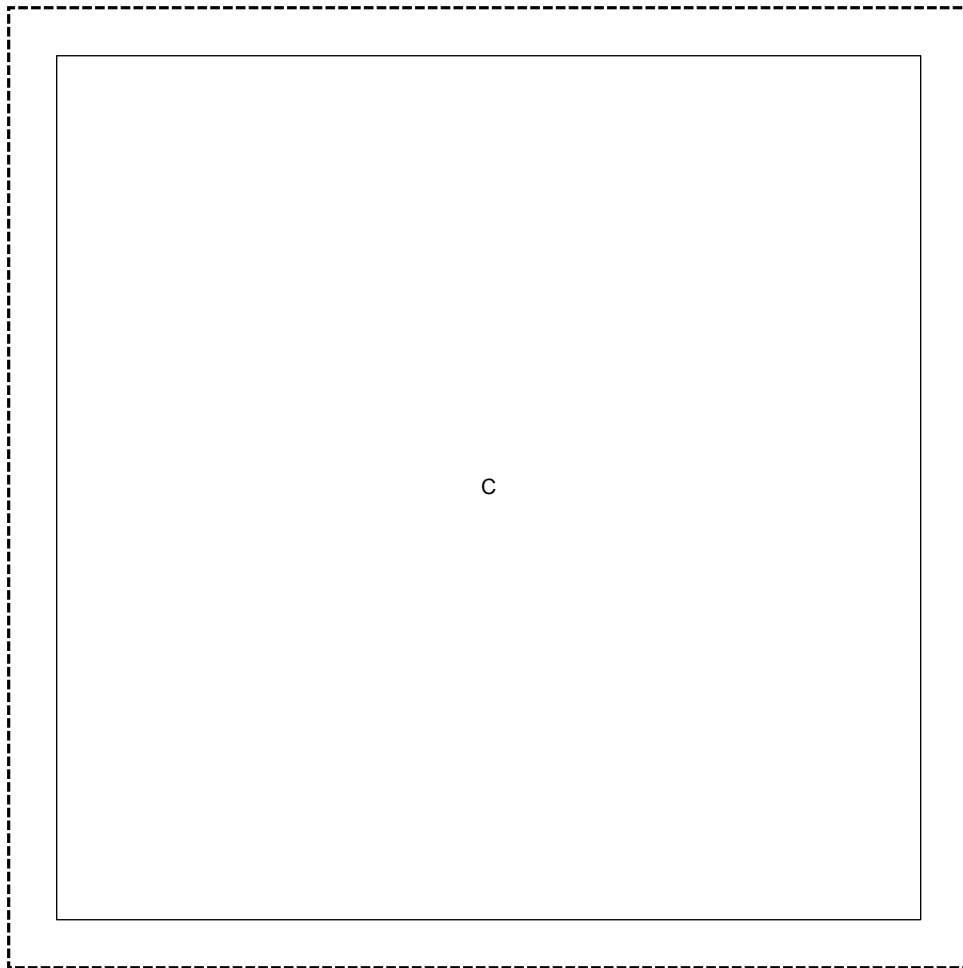
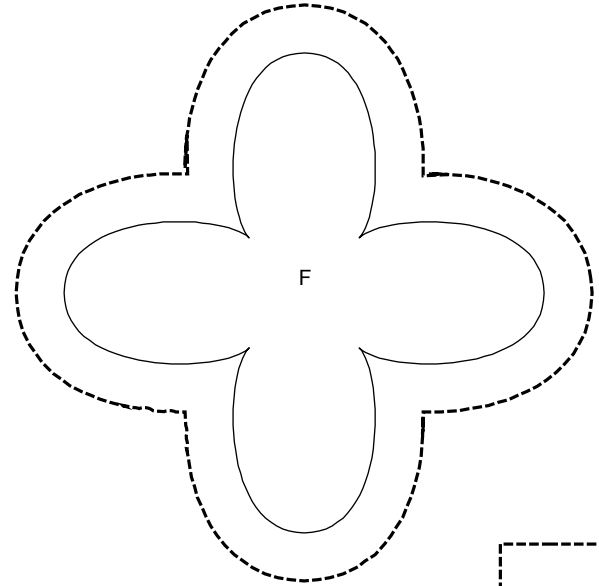
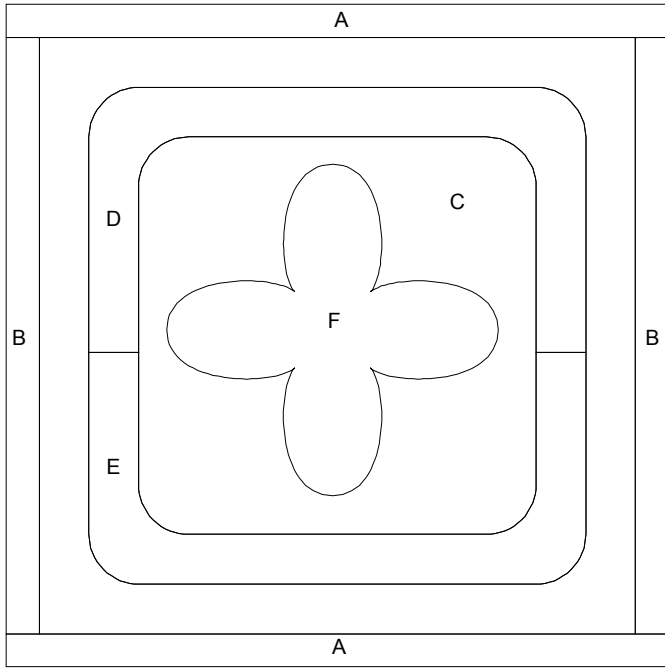



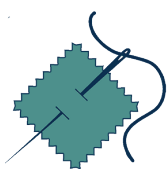



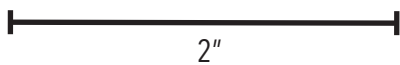
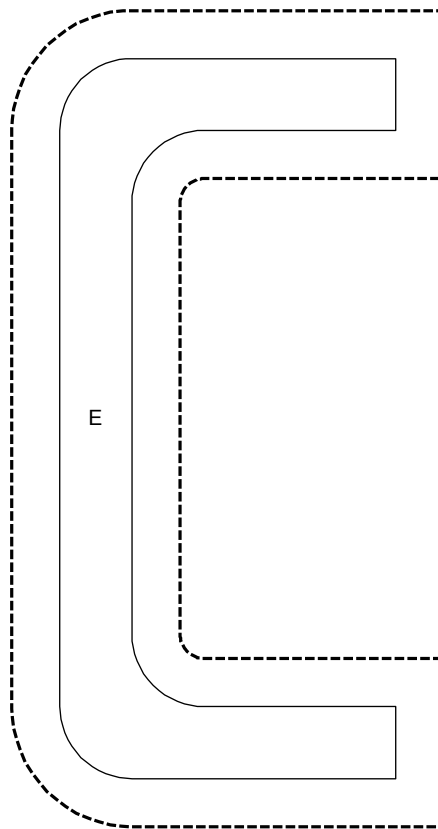
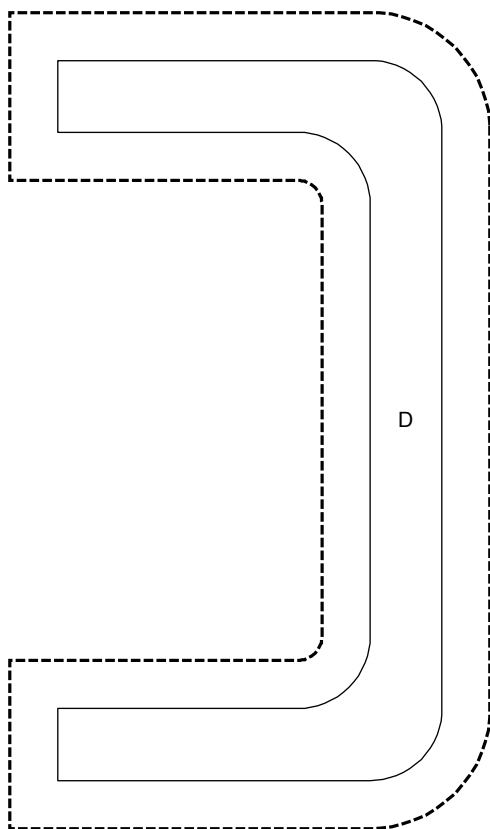

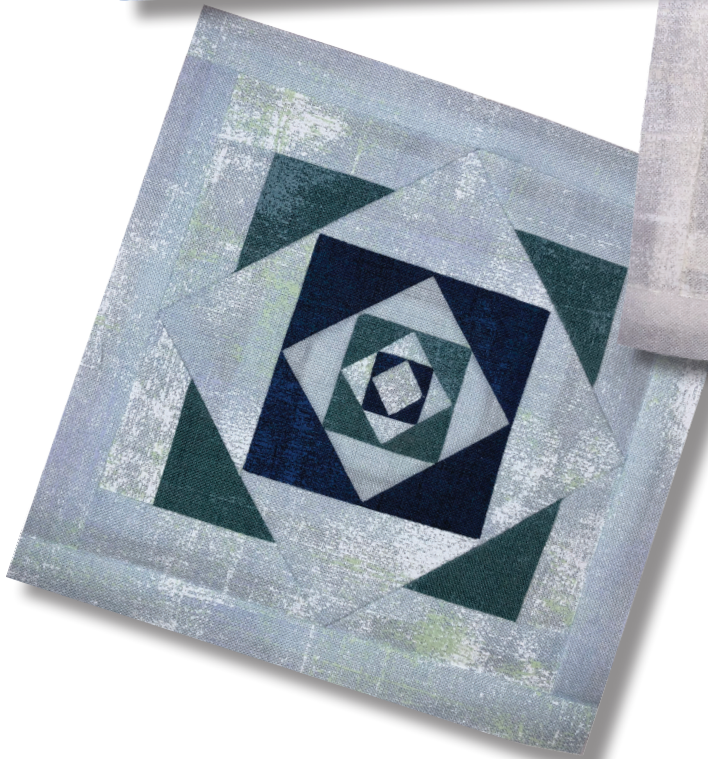

SET PRINTER TO "ACTUAL SIZE" WHEN PRINTING THIS PAGE.



## The Jane Stickle Quilt - Block G4



### What you need:

Patches	Quantity/size	Patches	Quantity/size
A*	(2) 1" x 6"	H 	(1) 4" x 4", cut twice diagonally
B*	(2) 1" x 5"	I 	(2) 2" x 2", cut once diagonally
C	(2) 1½" x 3½"	J 	(2) 1½" x 1½", cut once diagonally
D	(2) 1½" x 3½"	K 	(1) 2½" x 2½", cut twice diagonally
E	(2) 1½" x 3"	L 	(1) 2" x 2", cut twice diagonally
F	(2) 1½" x 3"	M	(1) 1½" x 1½"
G 	(2) 2½" x 2½", cut once diagonally - green (2) 2½" x 2½", cut once diagonally - navy		

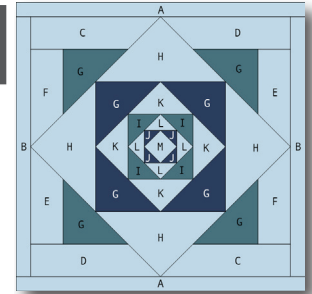

Hobbystash Colorway

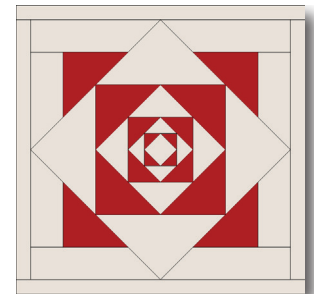

Jane Stickle Colorway

*\*The actual required width for Unit A and Unit B units is ¾". The increased width specified above allows for squaring the block to exactly 5½".*

### Assembly:

1. Using templates on Page G4-2, foundation piece sections.
2. Assemble sections and sew together.
3. Join Unit B to the right side of the block, and then the left.
4. Join Unit A to the top of the block and then the bottom. Square up block to measure 5½" x 5½" square.

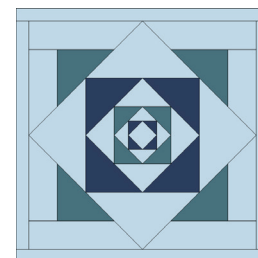
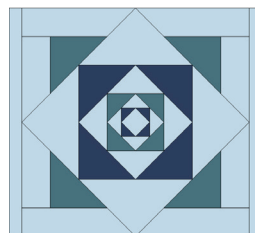
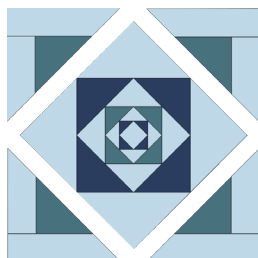

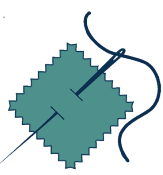

SET PRINTER TO "ACTUAL SIZE" WHEN PRINTING THIS PAGE.

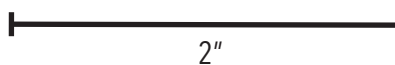
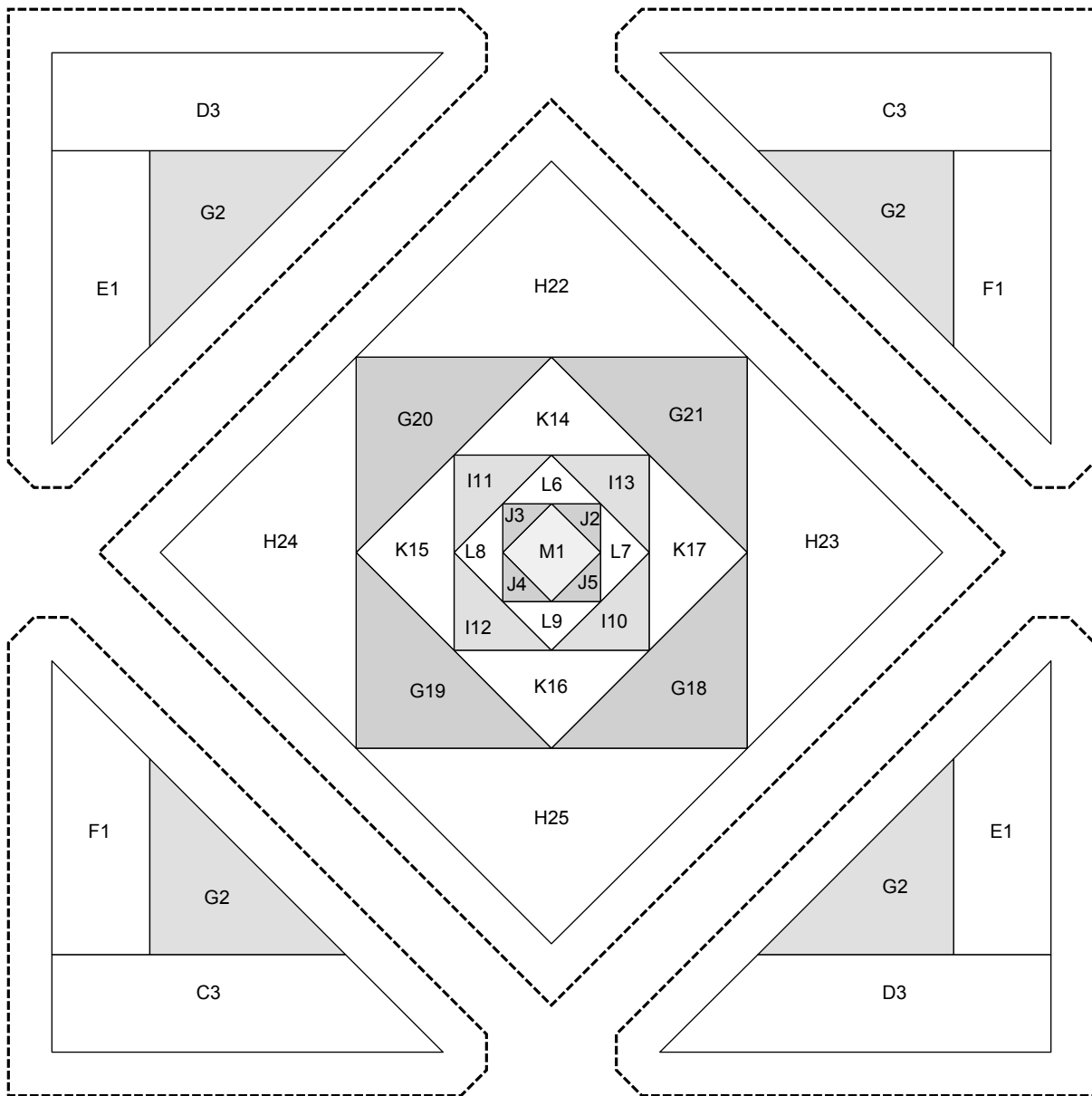

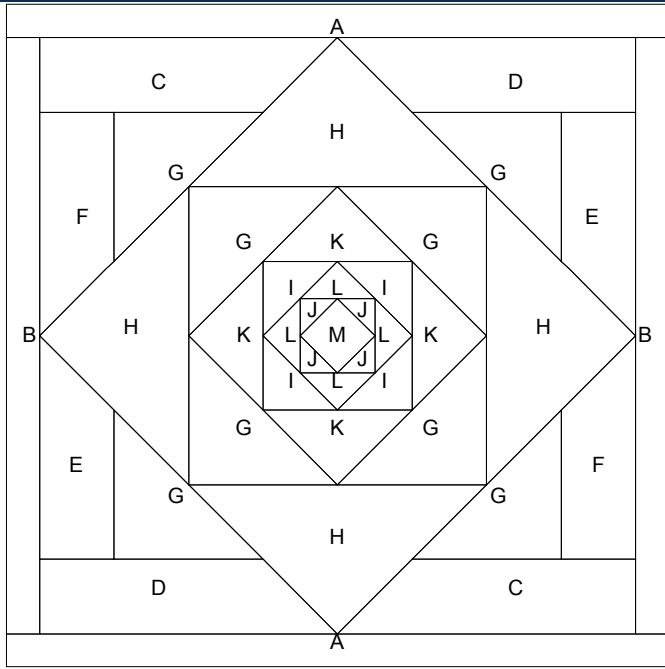

SET PRINTER TO "ACTUAL SIZE" WHEN PRINTING THIS PAGE.

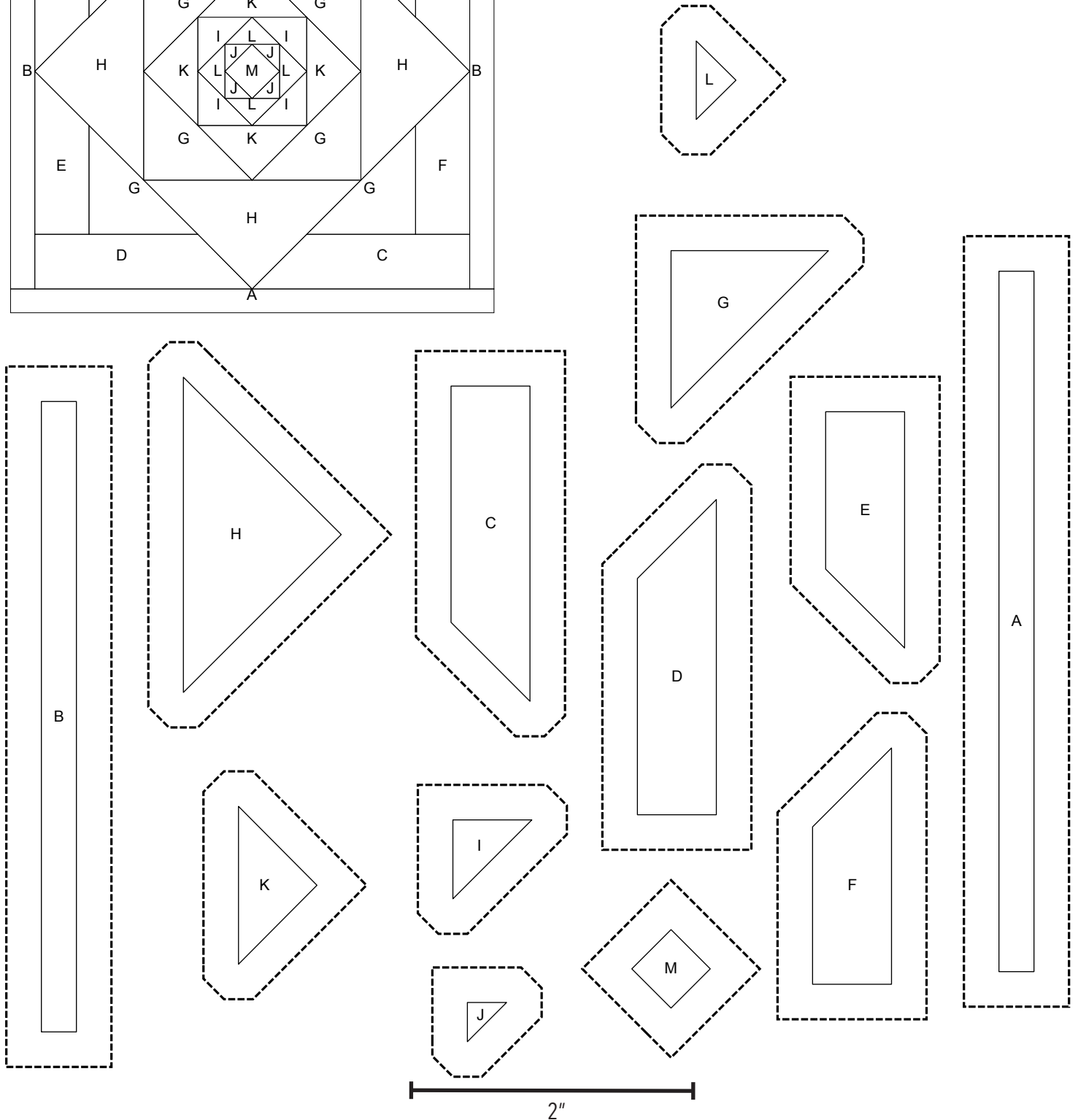

## The Jane Stickle Quilt - Block G5



### What you need:

Patches	Quantity/size
A*	(2) 1" x 6"
B*	(2) 1" x 5"
C	(2) 1¼" x 4"
D	(1) 5½" x 5½", cut twice diagonally
E	(1) 1¼" x 7¼"
F	(1) 4" x 4"

*\*The actual required width for Unit A and Unit B units is ¾". The increased width specified above allows for squaring the block to exactly 5½".*

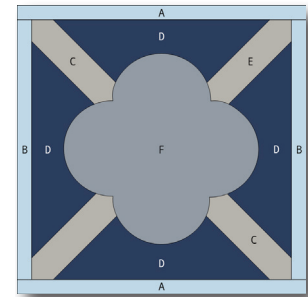

*Hobbystash Colorway*

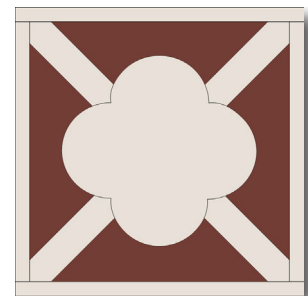

*Jane Stickle Colorway*

### Assembly:

1. Using templates on Page G5-2, foundation piece sections.
2. Assemble sections and sew together.
3. Using the template provided on Page G5-2, appliqué Unit F clover to Step 2 patch.
4. Join Unit B to the right side of the block, and then the left.
5. Join Unit A to the top of the block and then the bottom. Square up block to measure 5½" x 5½" square.

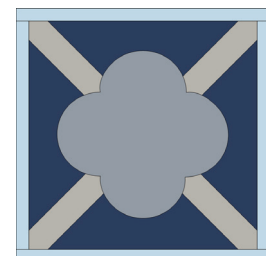
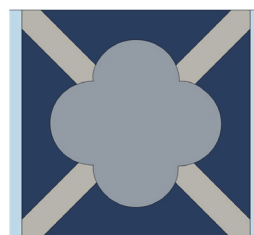

SET PRINTER TO "ACTUAL SIZE" WHEN PRINTING THIS PAGE.

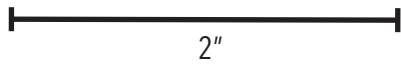
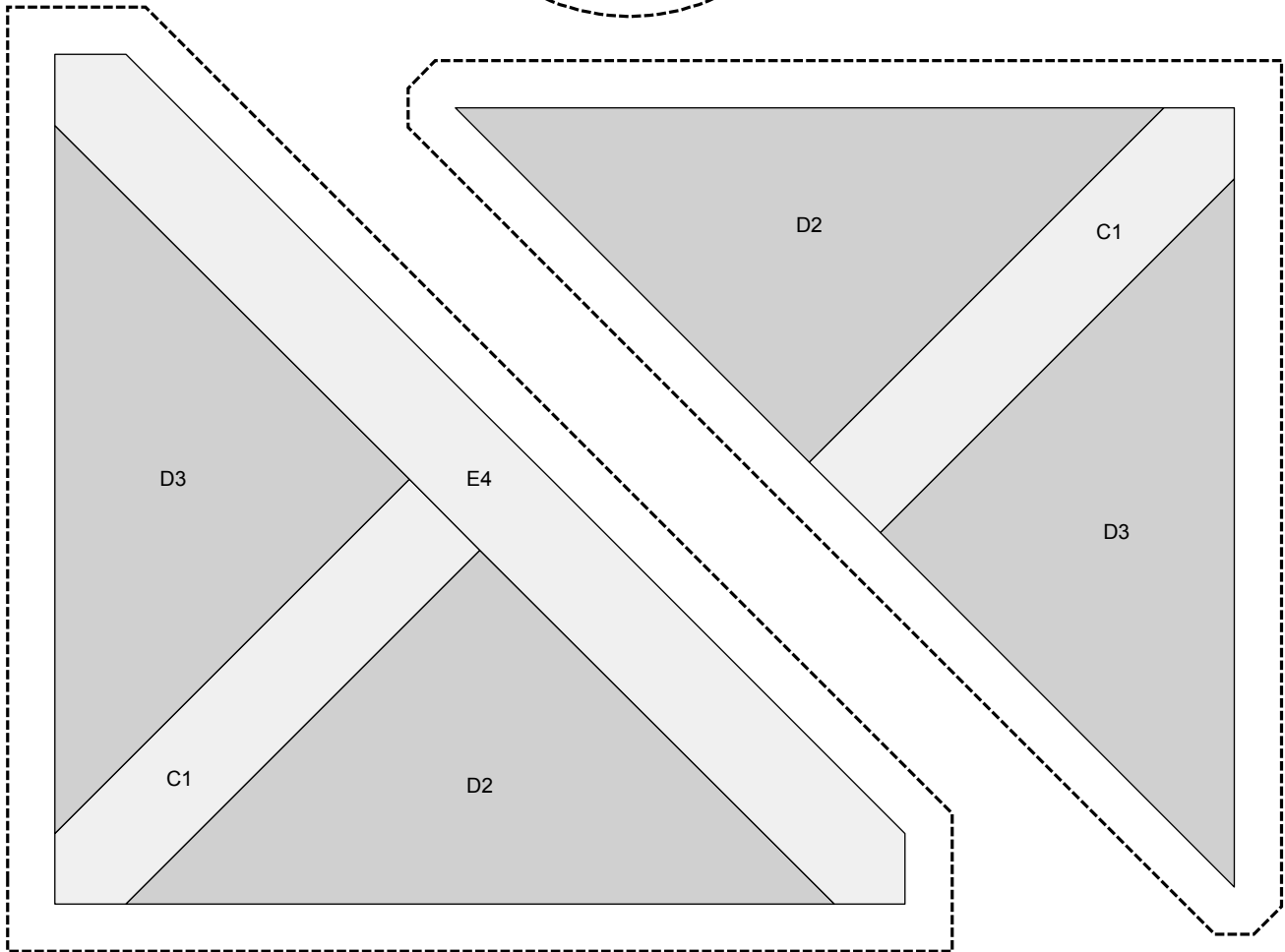
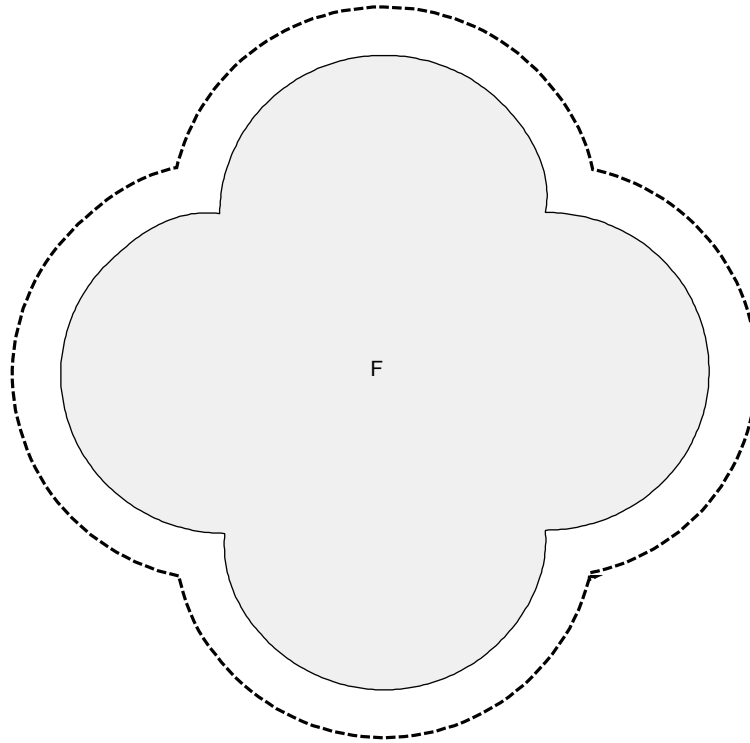



SET PRINTER TO "ACTUAL SIZE" WHEN PRINTING THIS PAGE.

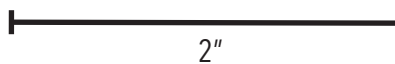
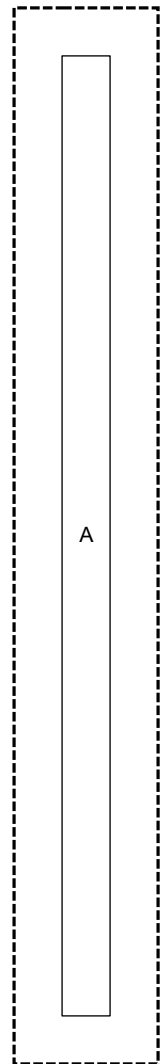
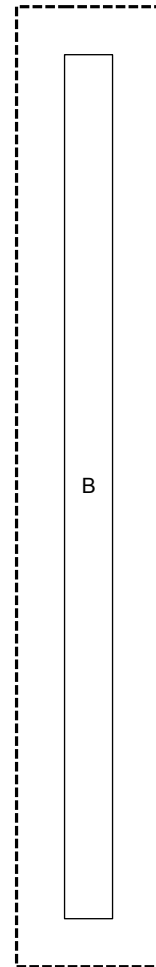
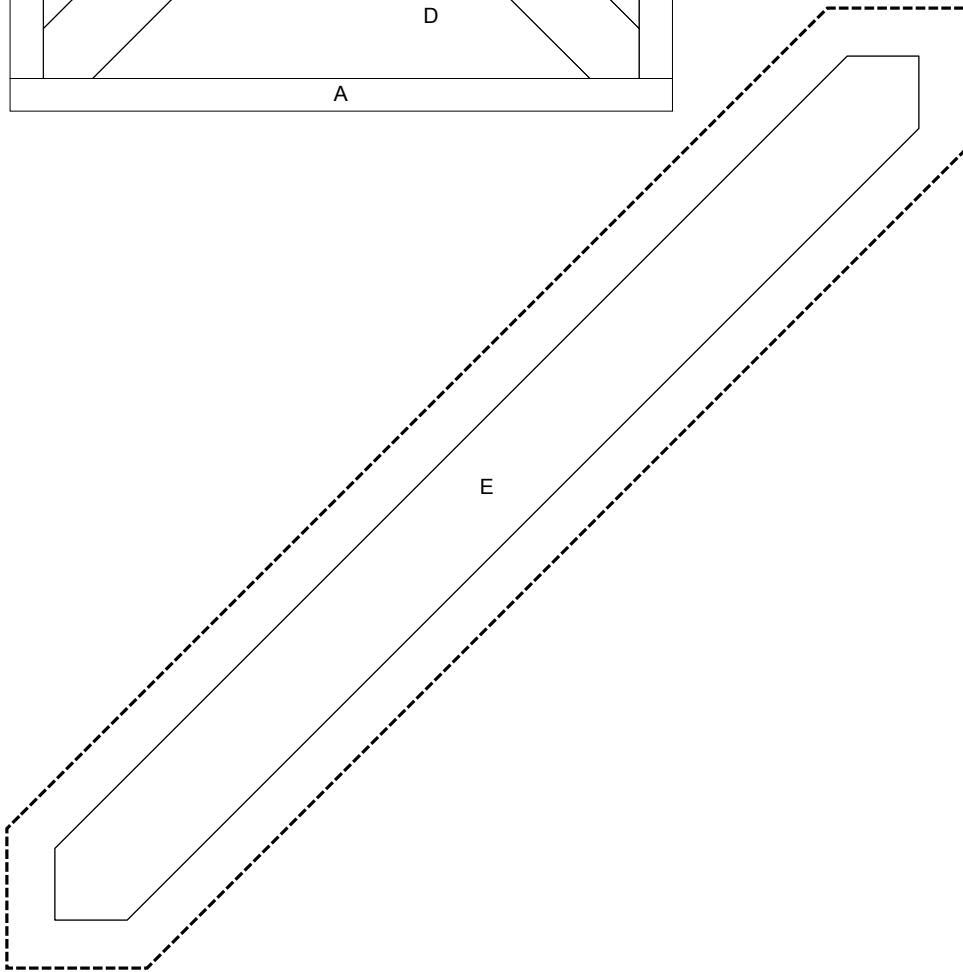
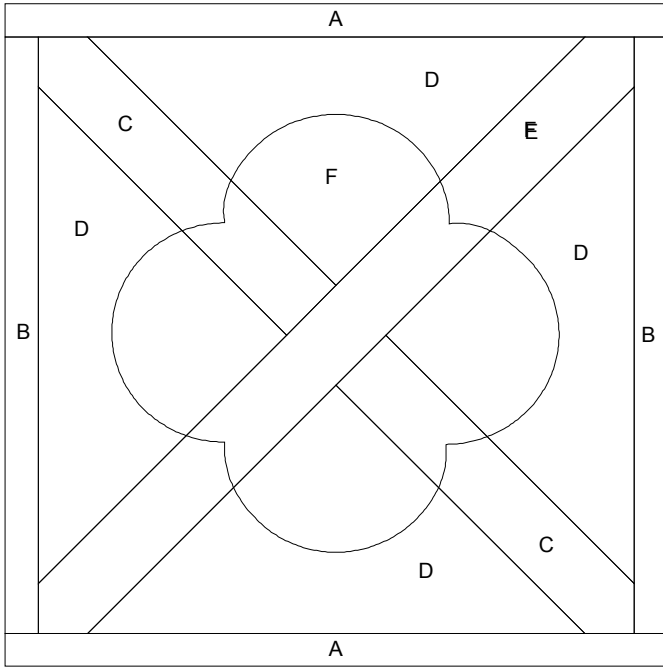

SET PRINTER TO "ACTUAL SIZE" WHEN PRINTING THIS PAGE.

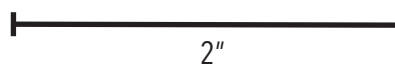
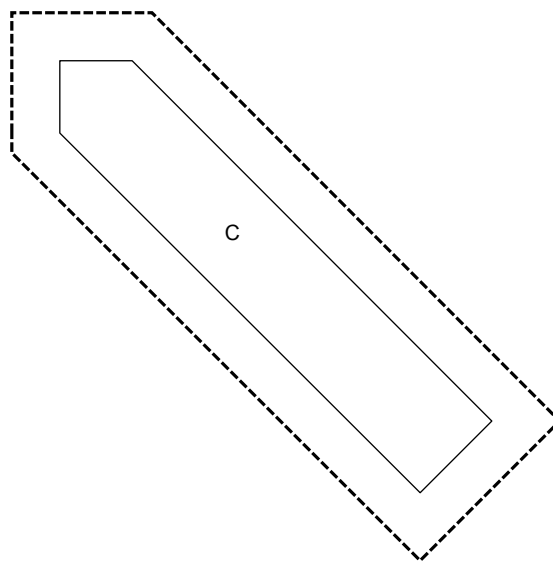
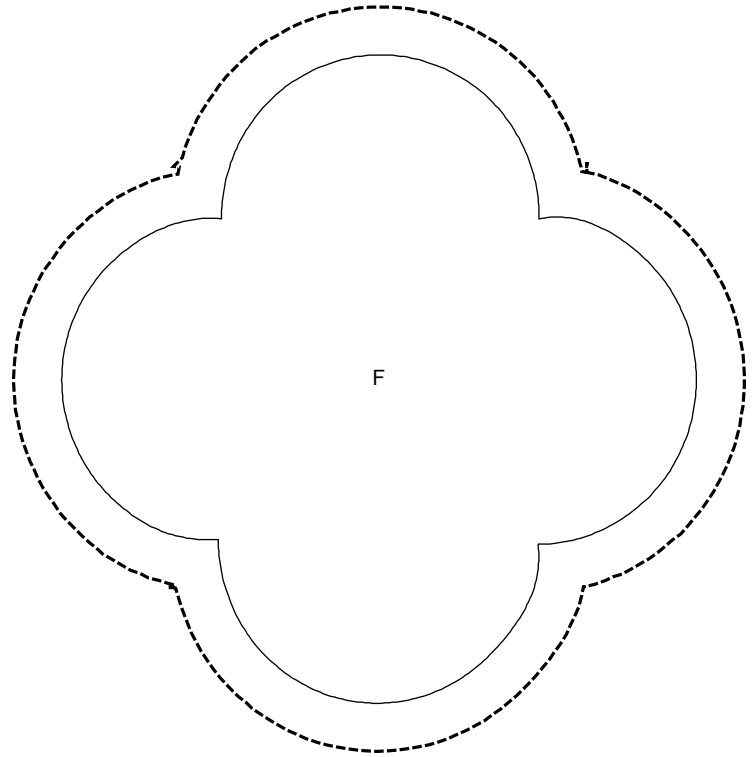
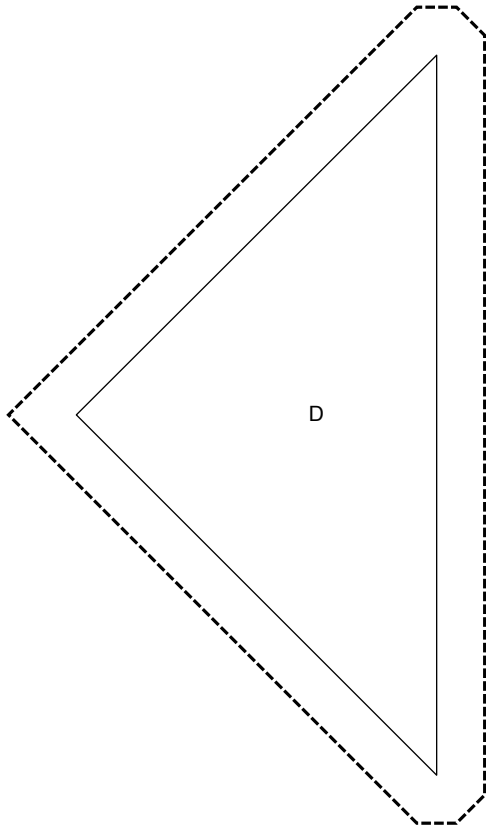

## The Jane Stickle Quilt - Block G6



### What you need:

Patches	Quantity/size	Patches	Quantity/size
A*	(2) 1" x 6"	J	(1) 2" x 3"
B*	(2) 1" x 5"	K	(1) 2" x 3½"
C	(1) 2½" x 3½"	L	(2) 2" x 4"
D	(1) 2½" x 3½"	M	(2) 2" x 2"
E	(1) 2½" x 5"	N	(4) 1" x 1"
F	(1) 2" x 5"	O	(1) 2" x 2" , cut twice diagonally
G	(1) 2½" x 5"	P	(4) 1½" x 1½" , cut once diagonally
H	(1) 2" x 3½"	Q	(1) 1½" x 1½"
I	(2) 2" x 3"		

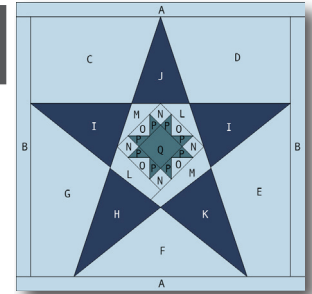

Hobbystash Colorway

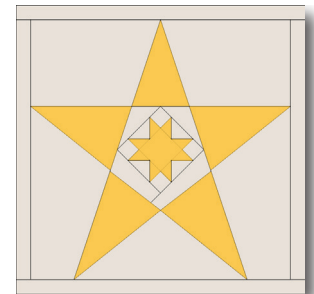

Jane Stickle Colorway

### Assembly:

- Using templates on Page G6-2, foundation piece inner star sections. Arrange and sew together.
- Using Inner star template on Page G6-3, cut inner star into pentagon shape.
- Using remaining templates on Page G6-3, foundation piece outer star sections. Arrange and sew together.
- Join Unit B to the right side of the block, and then the left.
- Join Unit A to the top of the block and then the bottom. Square up block to measure 5½" x 5½" square.

*\*The actual required width for Unit A and Unit B units is ¾". The increased width specified above allows for squaring the block to exactly 5½".*

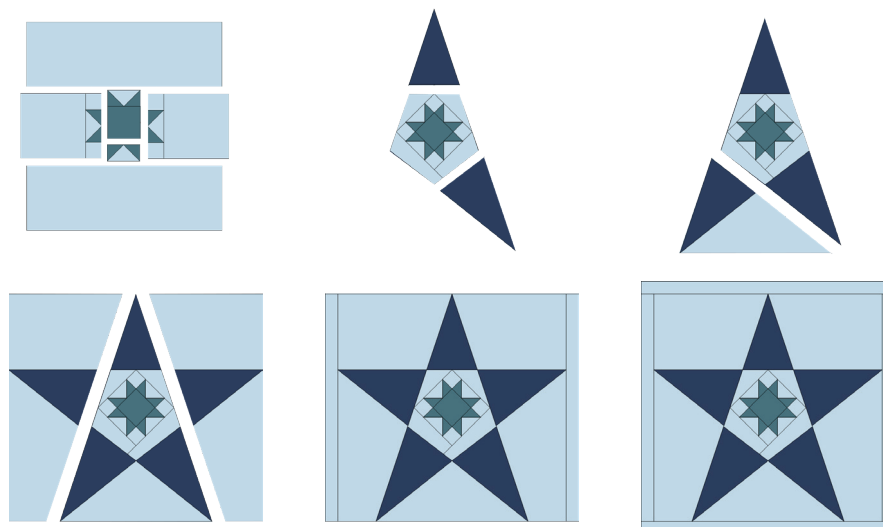

SET PRINTER TO "ACTUAL SIZE" WHEN PRINTING THIS PAGE.

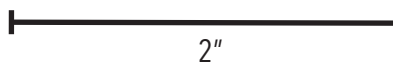
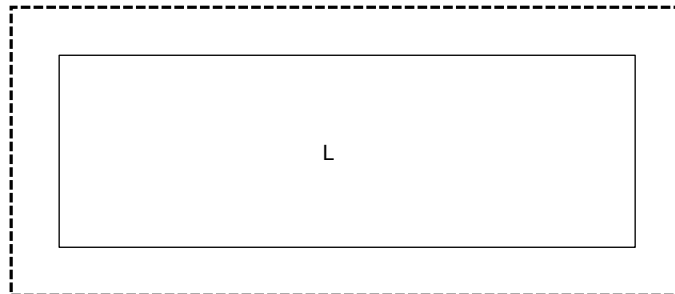
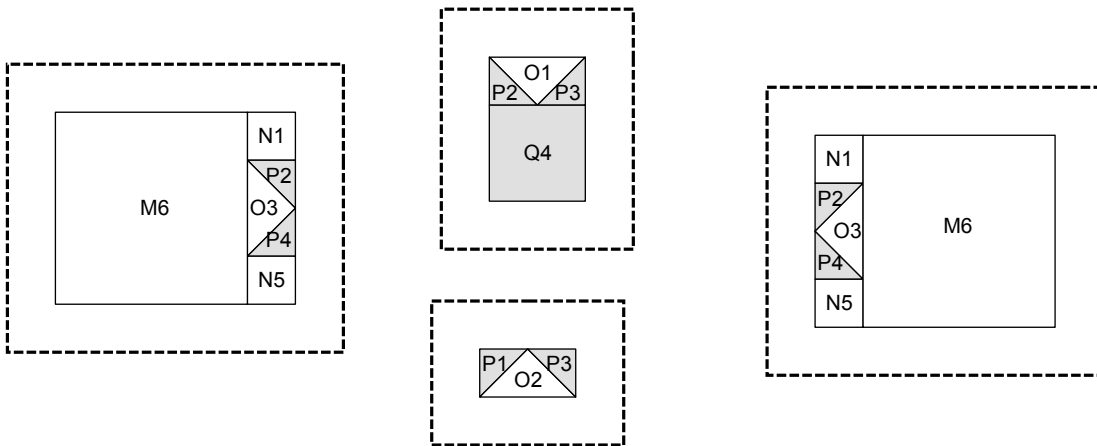
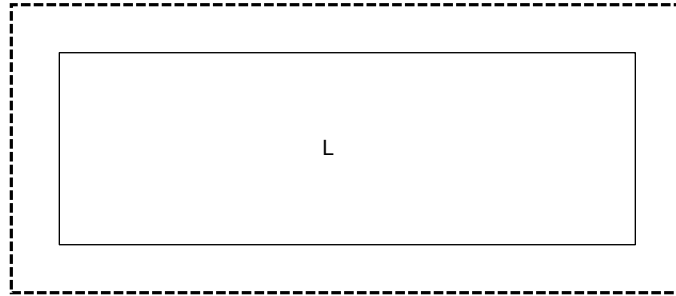

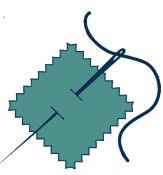

SET PRINTER TO "ACTUAL SIZE" WHEN PRINTING THIS PAGE.

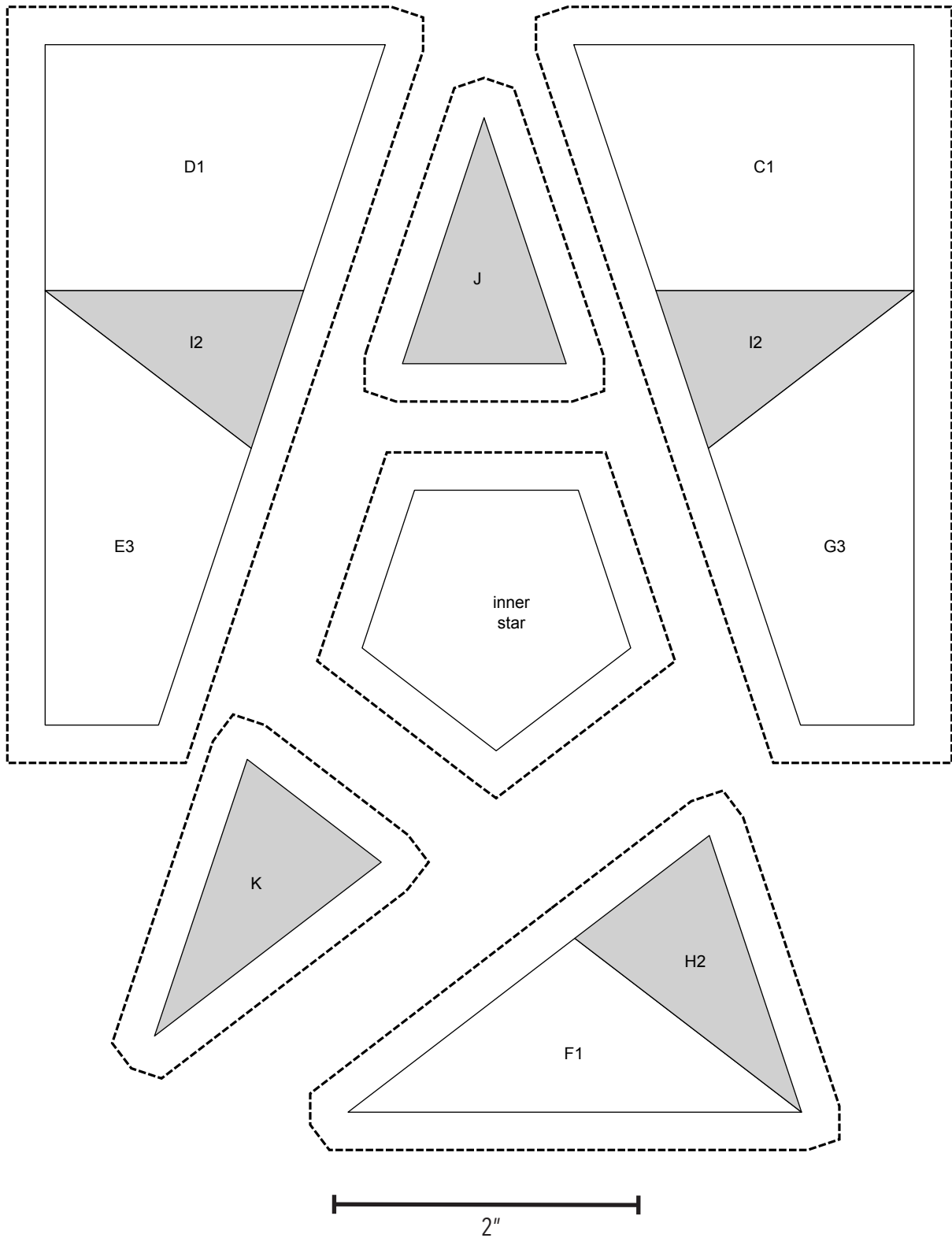

SET PRINTER TO "ACTUAL SIZE" WHEN PRINTING THIS PAGE.

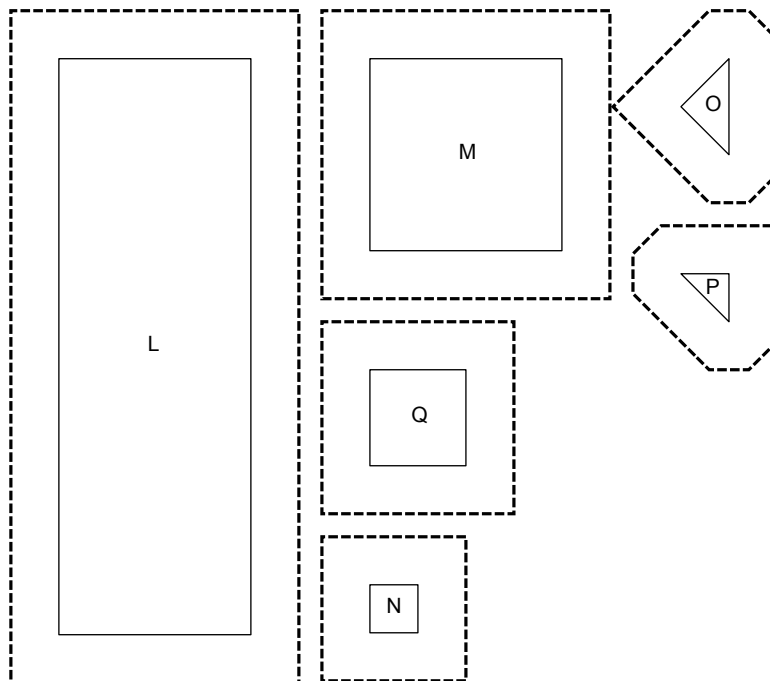
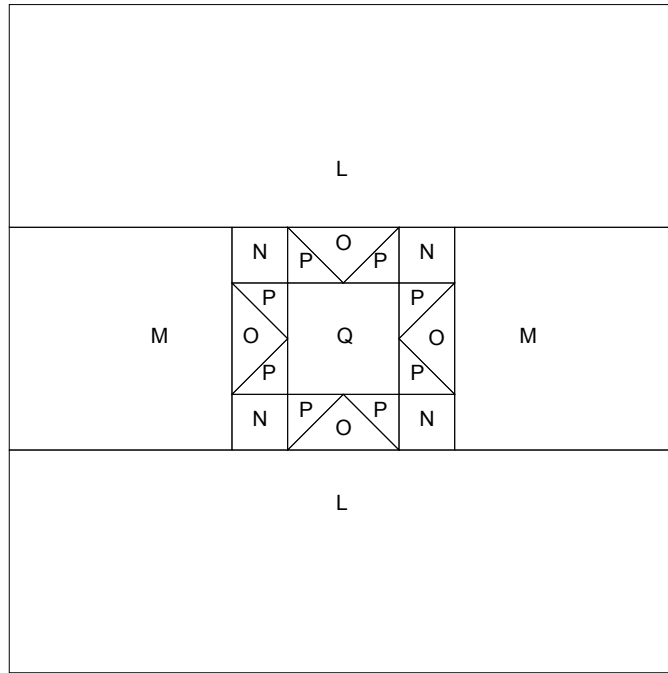

2"

SET PRINTER TO "ACTUAL SIZE" WHEN PRINTING THIS PAGE.

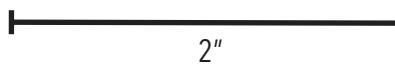
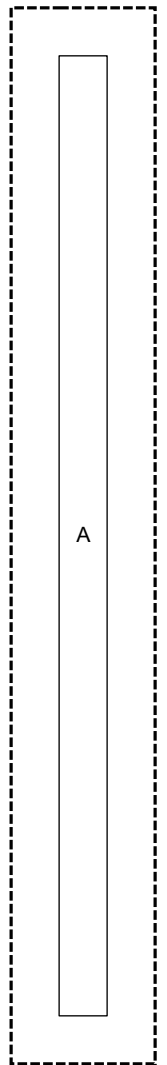
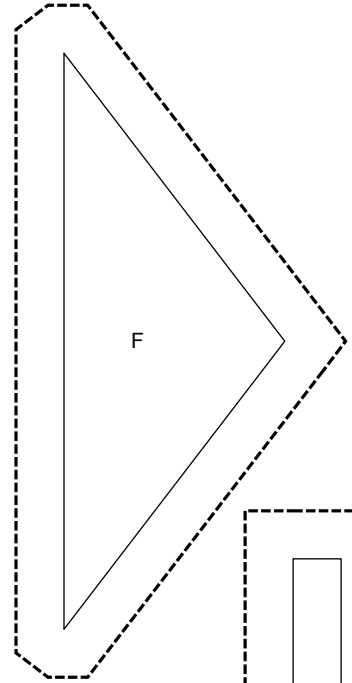
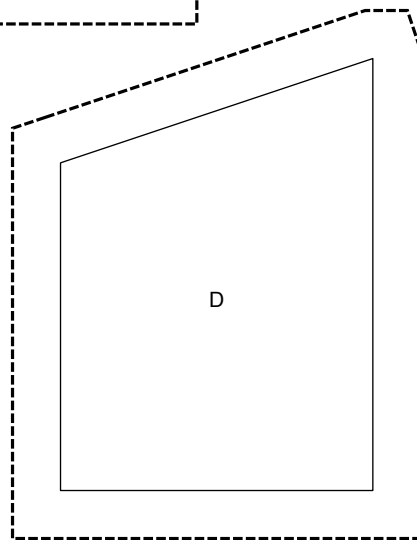
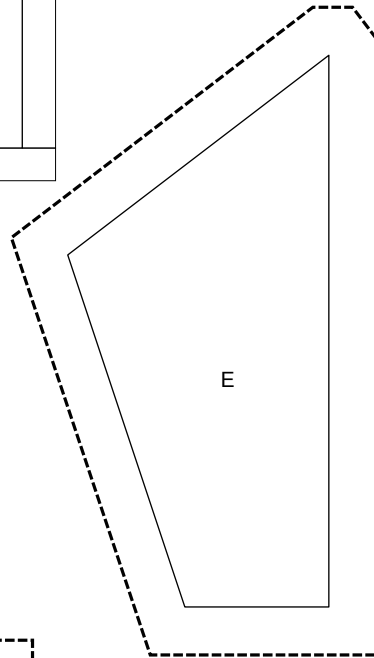
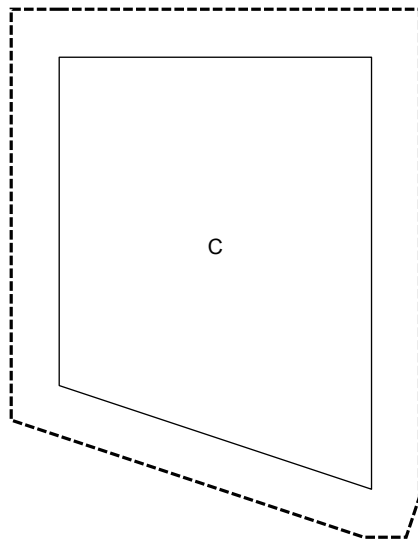
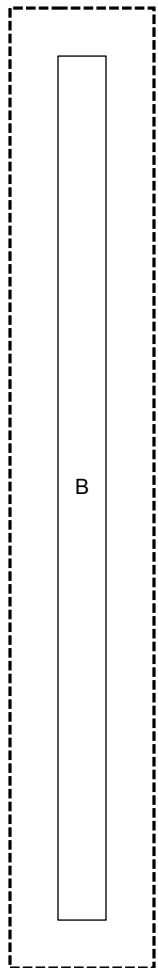
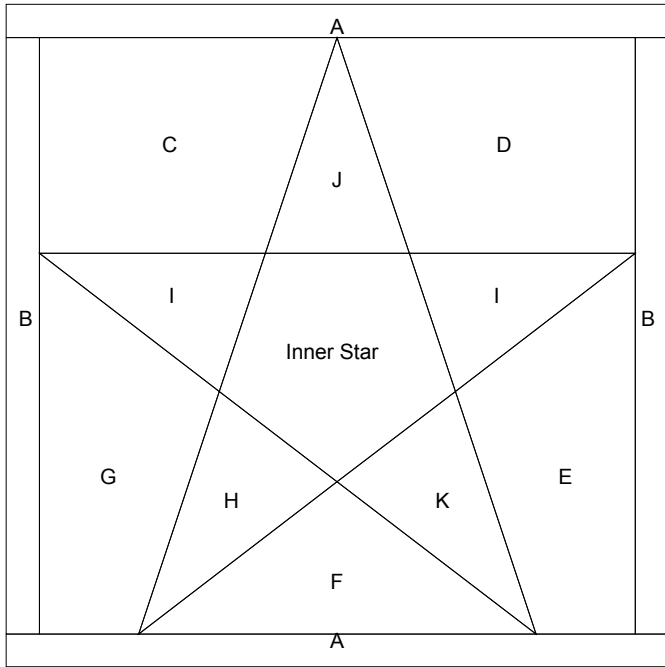



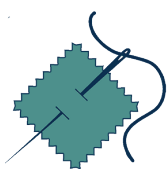

SET PRINTER TO "ACTUAL SIZE" WHEN PRINTING THIS PAGE.

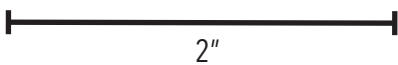
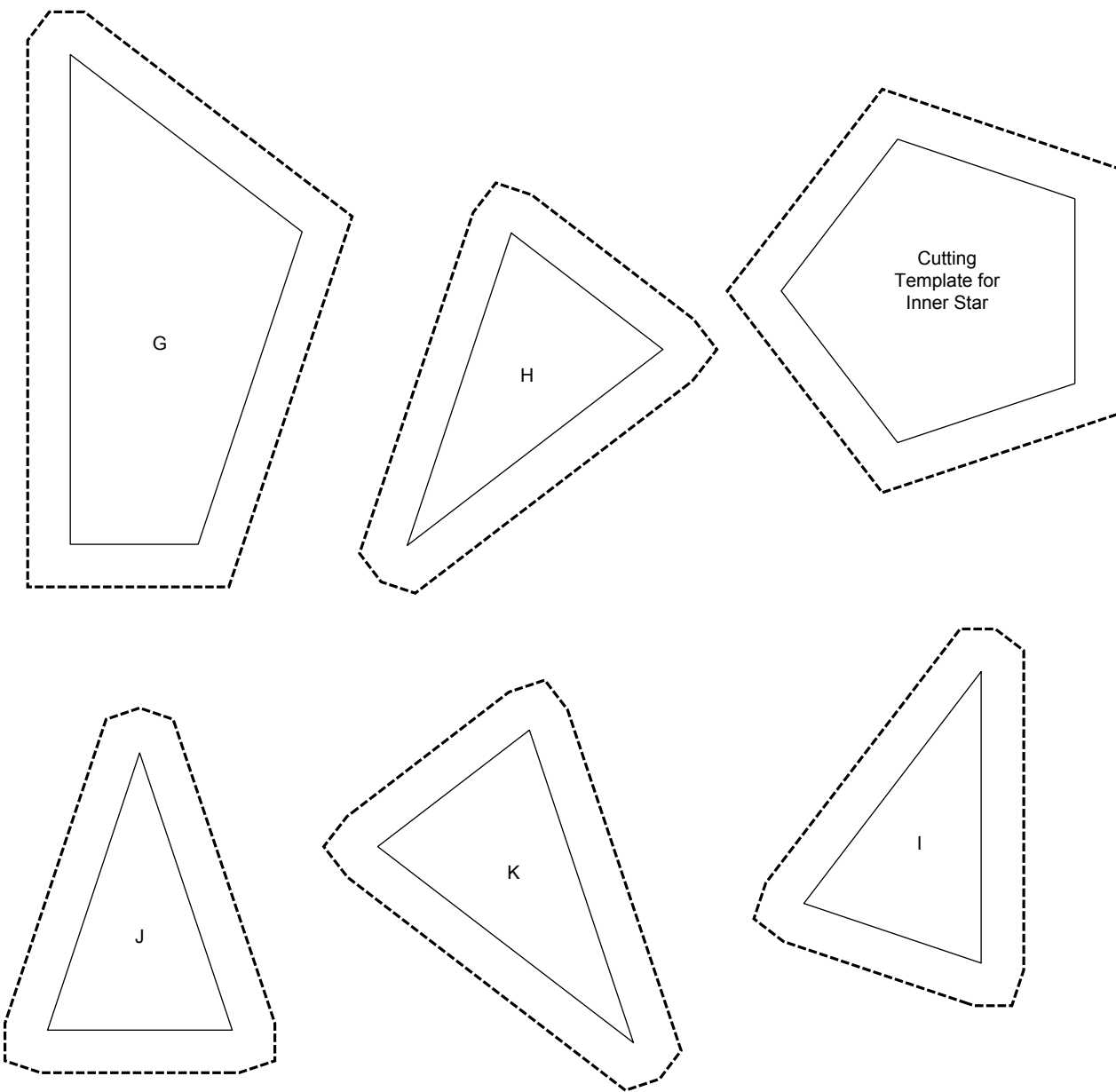

## The Jane Stickle Quilt - Block G7

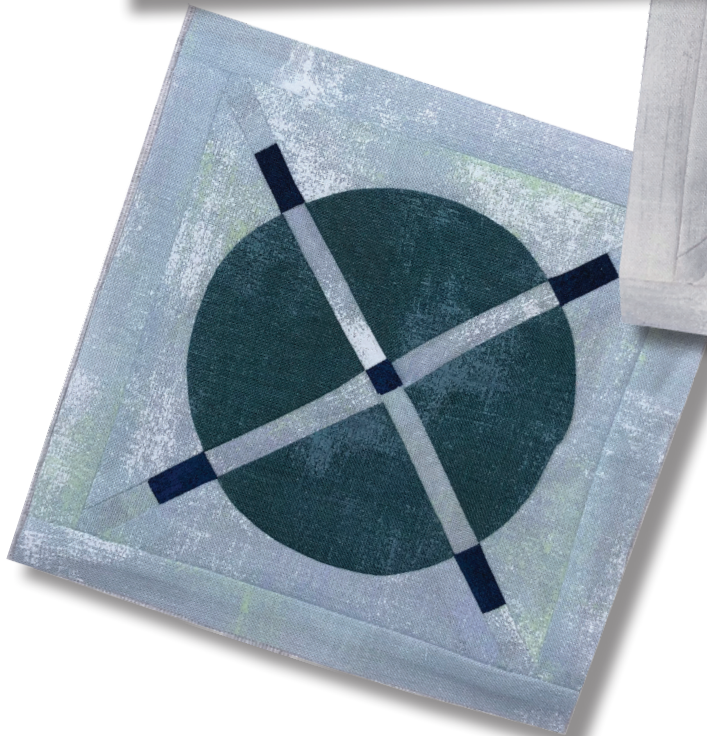

### What you need:

Patches	Quantity/size
A*	(2) 1" x 6"
B*	(2) 1" x 5"
C	(4) 1" x 2"
D	(1) 6" x 6", cut twice diagonally
E	(4) 1" x 1½"
F	(4) 1" x 2½"
G	(1) 5½" x 5½", cut twice diagonally
H	(1) 1" x 1"

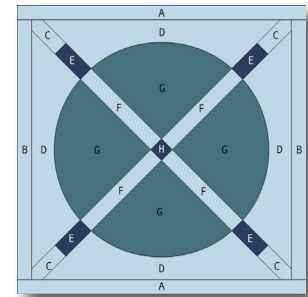

*Hobbystash Colorway*

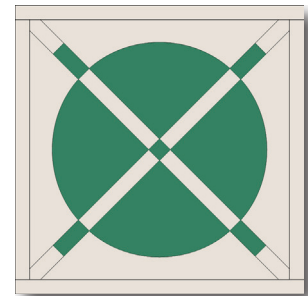

*Jane Stickle Colorway*

*\*The actual required width for Unit A and Unit B units is ¾". The increased width specified above allows for squaring the block to exactly 5½".*

### Assembly:

1. Using templates on Page G7-2 and G7-3, curve piece or appliqué Unit G to Unit D. Make 4.
2. Using templates on Page G7-4, foundation piece remaining sections of block.
3. Assemble sections from Step 1 and Step 2. Sew together.
4. Join Unit B to the right side of the block, and then the left.
5. Join Unit A to the top of the block and then the bottom. Square up block to measure 5½" x 5½" square.

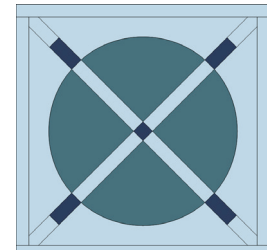
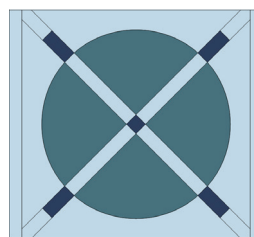
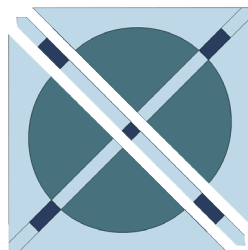

SET PRINTER TO "ACTUAL SIZE" WHEN PRINTING THIS PAGE.

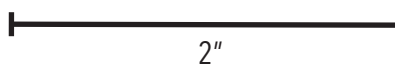
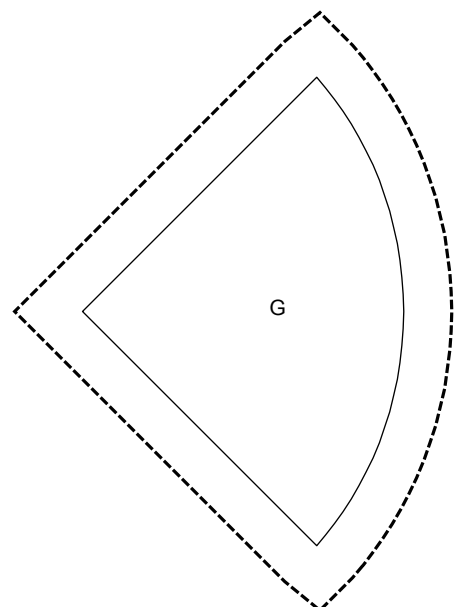
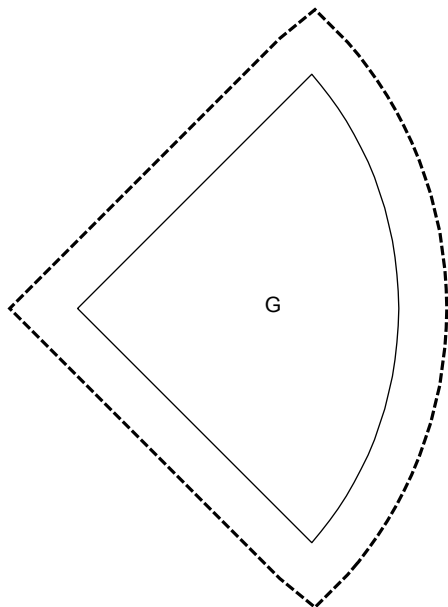
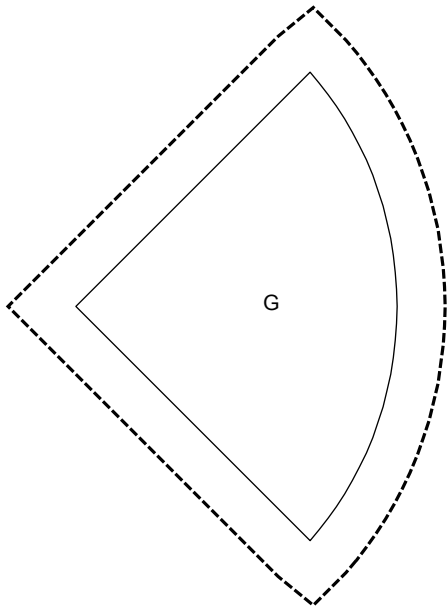
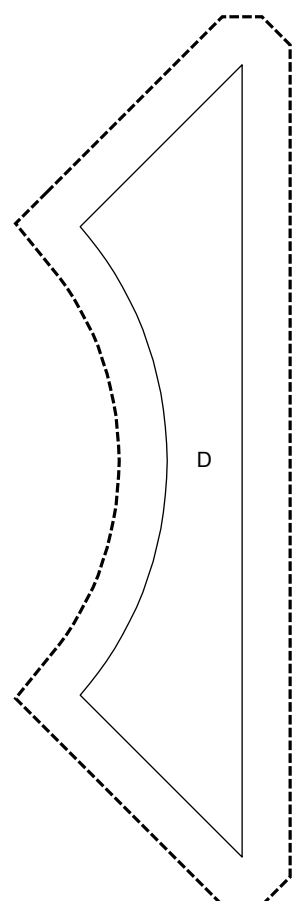
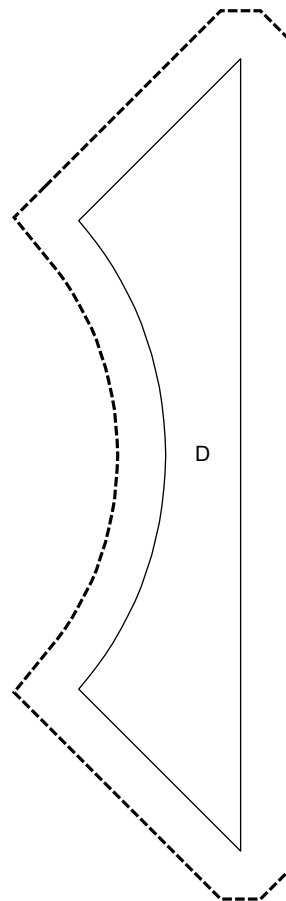
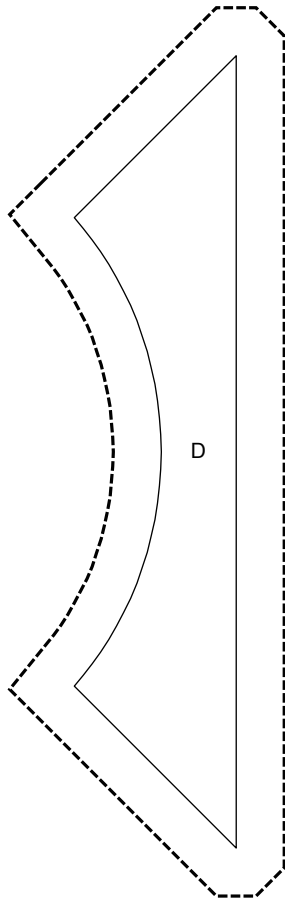
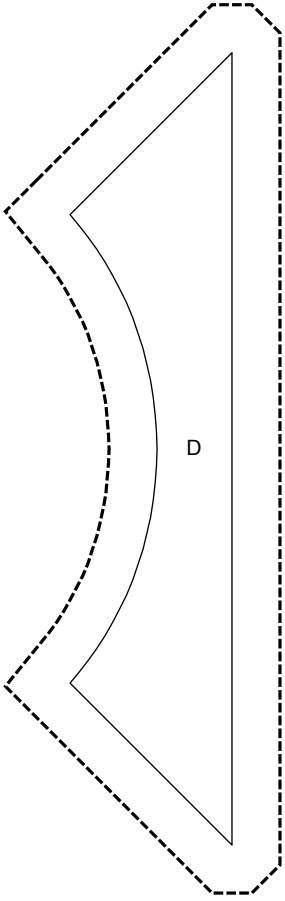

SET PRINTER TO "ACTUAL SIZE" WHEN PRINTING THIS PAGE.

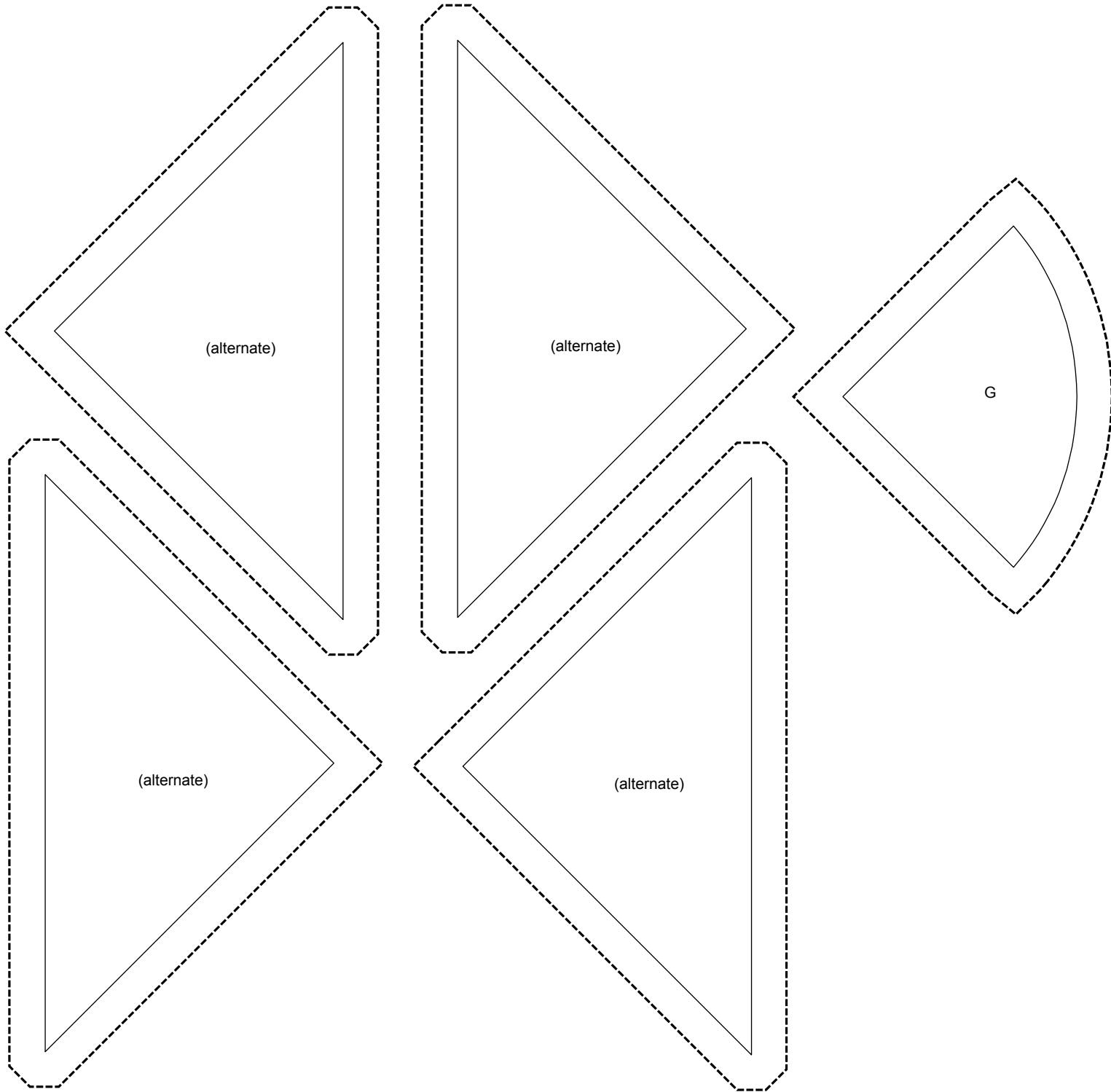

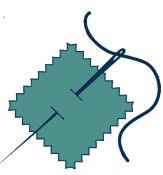

SET PRINTER TO "ACTUAL SIZE" WHEN PRINTING THIS PAGE.

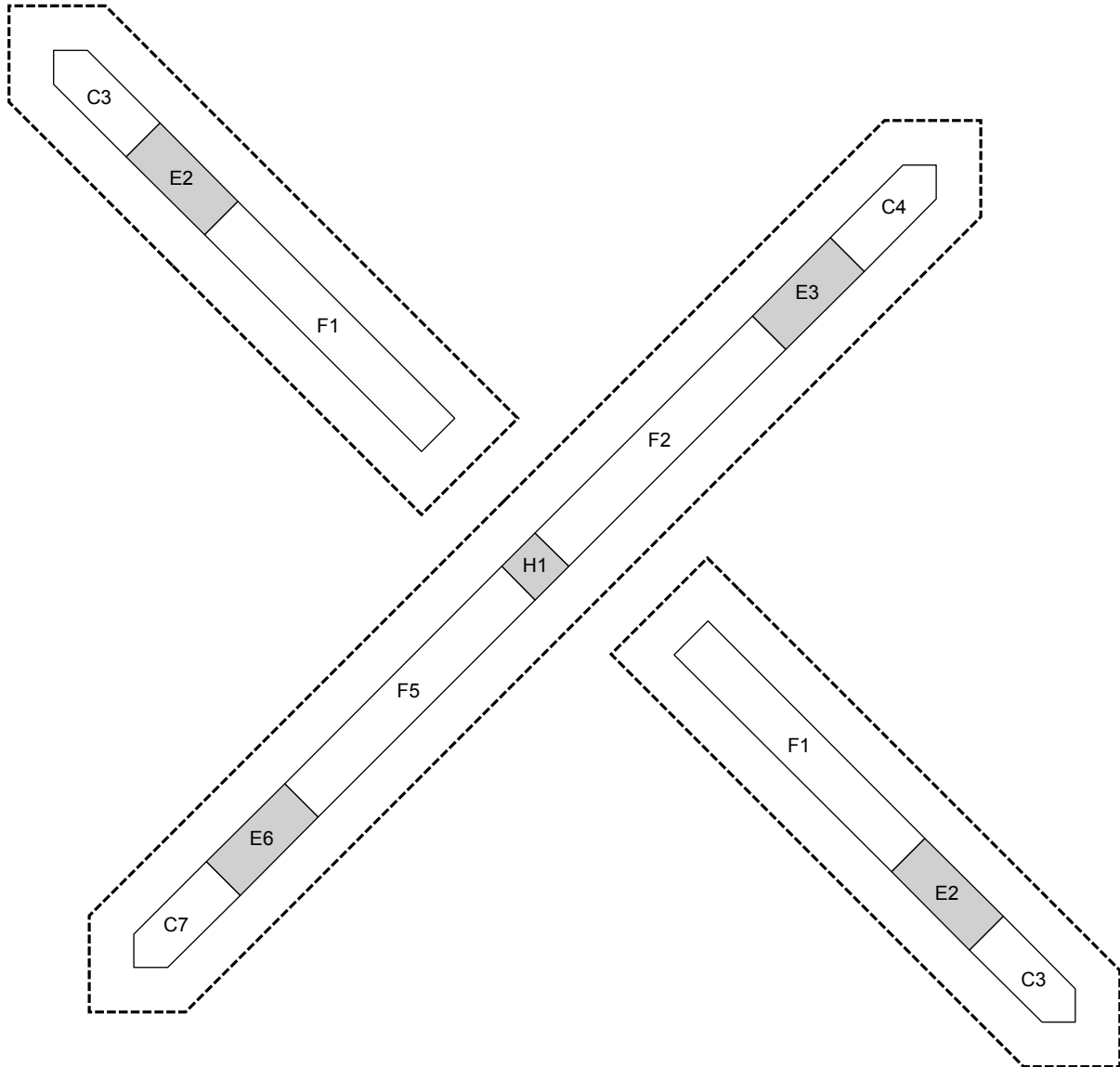

SET PRINTER TO "ACTUAL SIZE" WHEN PRINTING THIS PAGE.

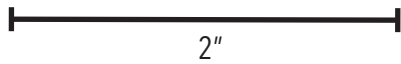
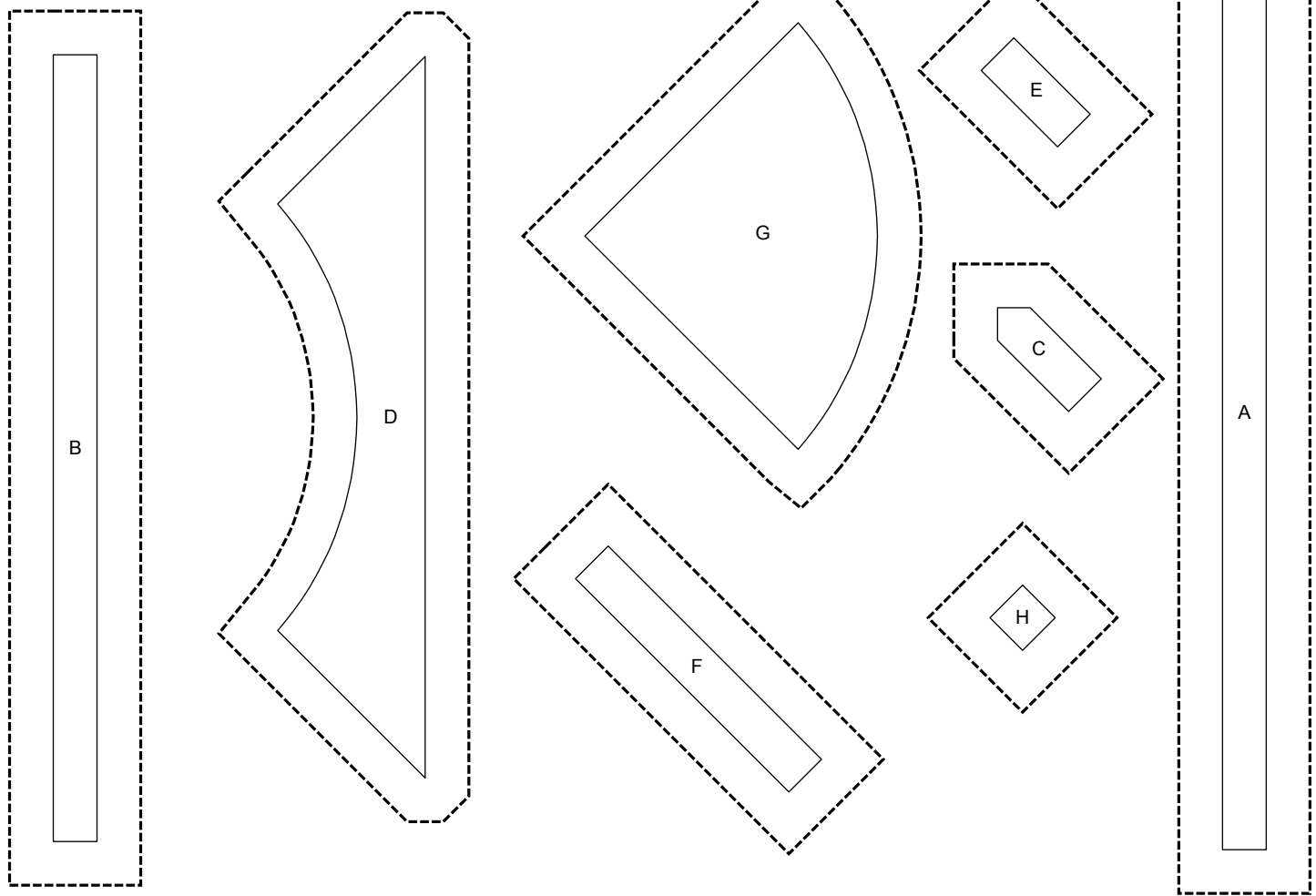
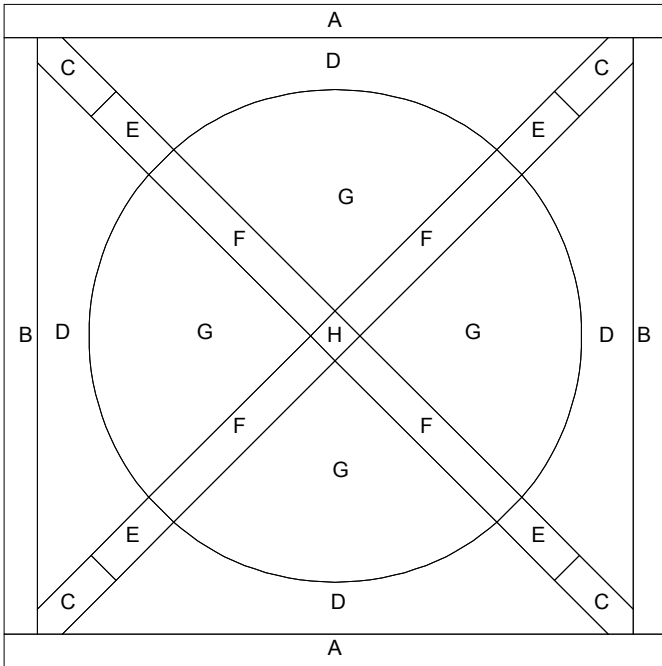

## The Jane Stickle Quilt - Block G8

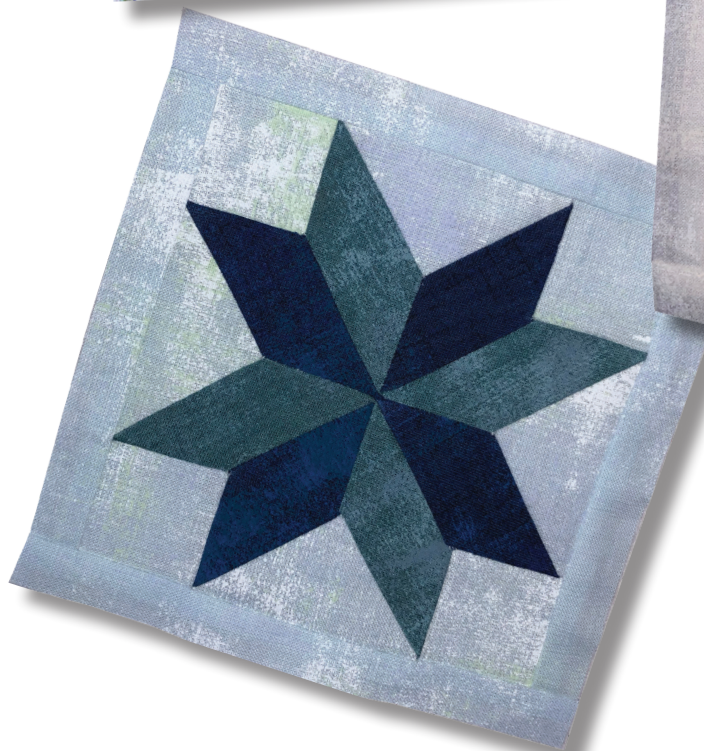



### What you need:

Patches	Quantity/size (with inset seams)	Alternate Quantity/Size (no inset seams)
A*	(2) 1" x 6"	(2) 1" x 6"
B*	(2) 1" x 5"	(2) 1" x 5"
C	(4) 2" x 2"	(8) 2½" x 2½", cut once diagonally
D	(1) 4" x 4", cut twice diagonally	NONE
E	(4) 1½" x 3½"	(4) 1½" x 3½"
F	(4) 1½" x 3½"	(4) 1½" x 3½"

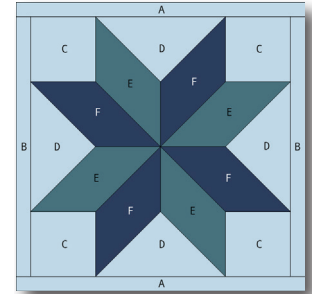

Hobbystash Colorway

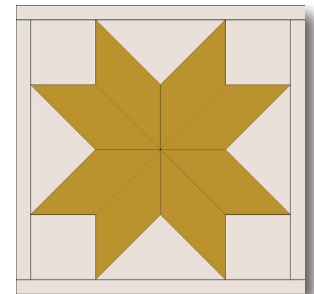

Jane Stickle Colorway

*\*The actual required width for Unit A and Unit B units is ¾". The increased width specified above allows for squaring the block to exactly 5½".*

### Assembly:

- Using templates on Page G8-2 (or alternate on Page G8-4), foundation piece sections.
- Assemble sections and sew together.
- Join Unit B to the right side of the block, and then the left.
- Join Unit A to the top of the block and then the bottom. Square up block to measure 5½" x 5½" square.

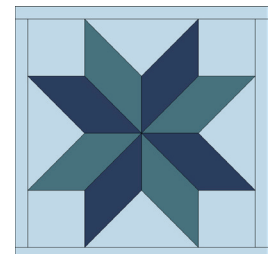
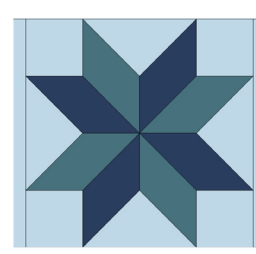
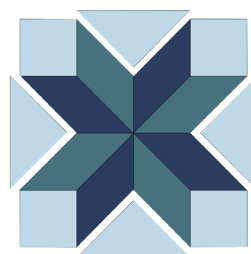
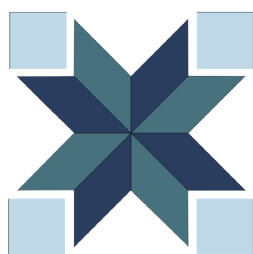

SET PRINTER TO "ACTUAL SIZE" WHEN PRINTING THIS PAGE.

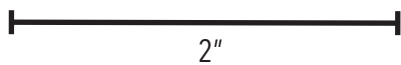
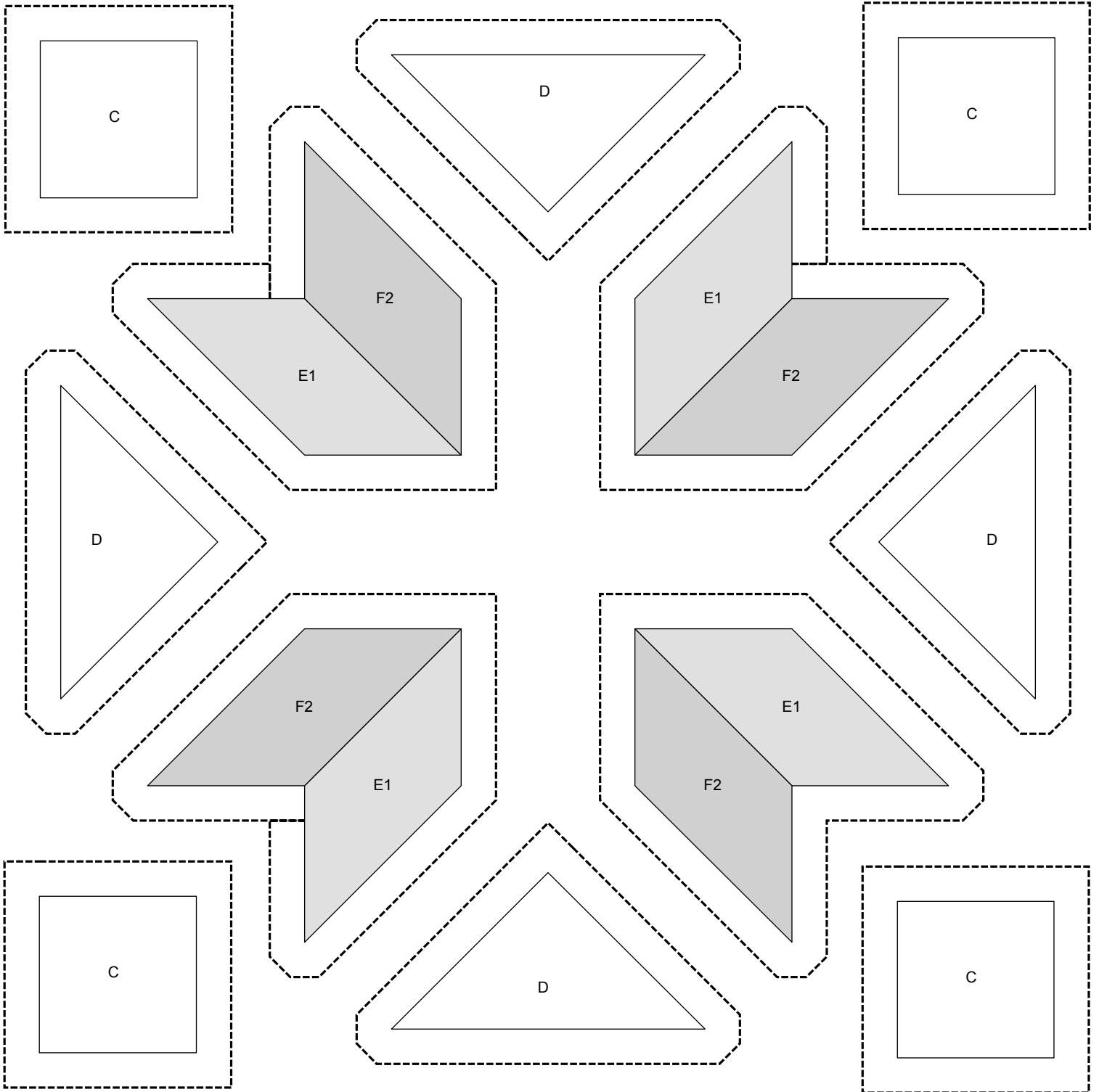

SET PRINTER TO "ACTUAL SIZE" WHEN PRINTING THIS PAGE.

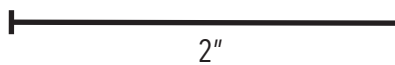
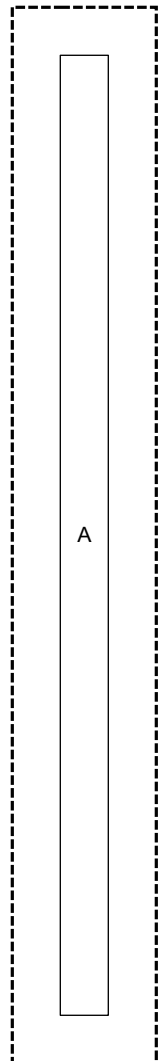
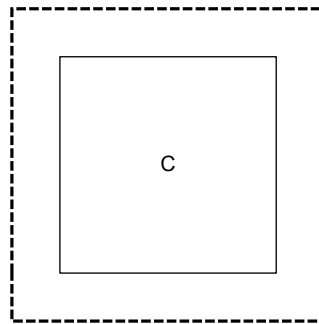
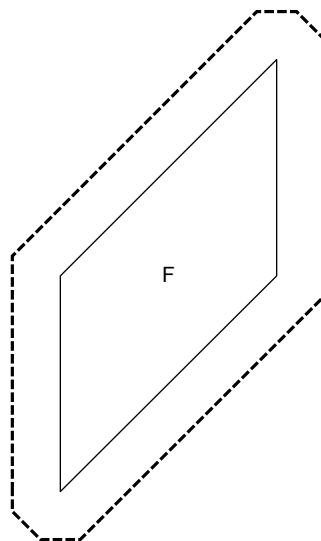
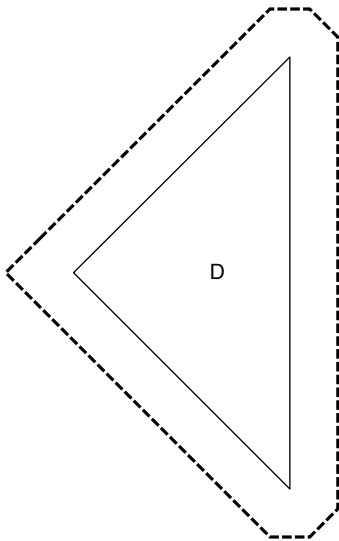
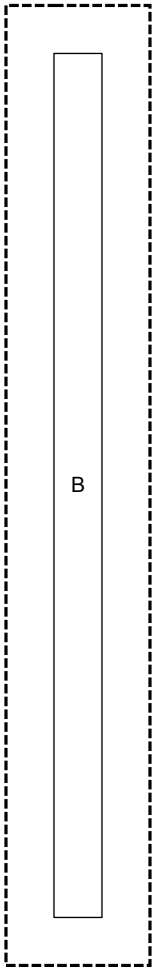
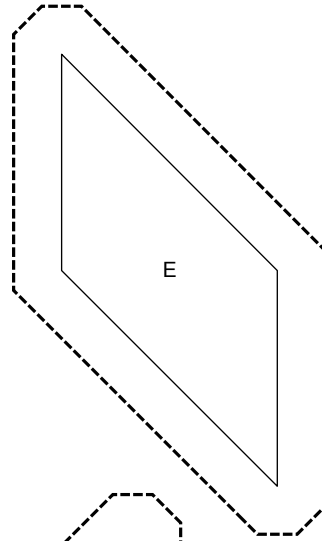
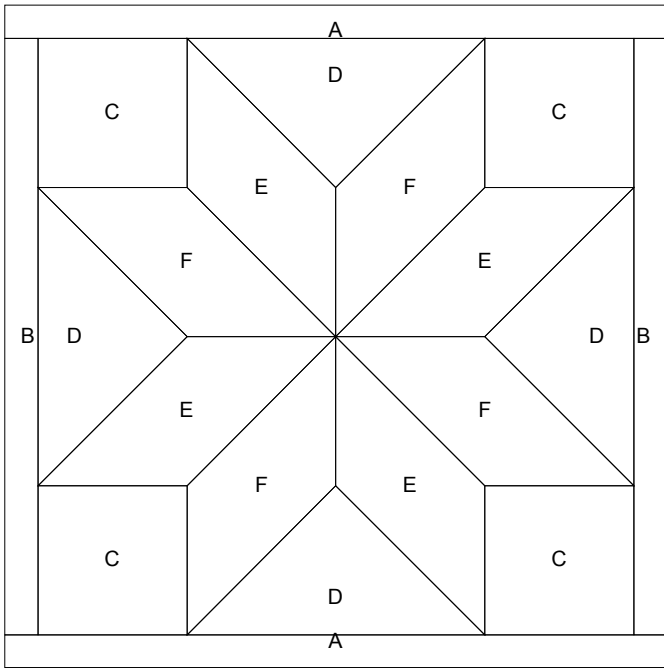

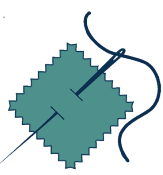

SET PRINTER TO "ACTUAL SIZE" WHEN PRINTING THIS PAGE.

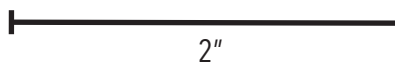
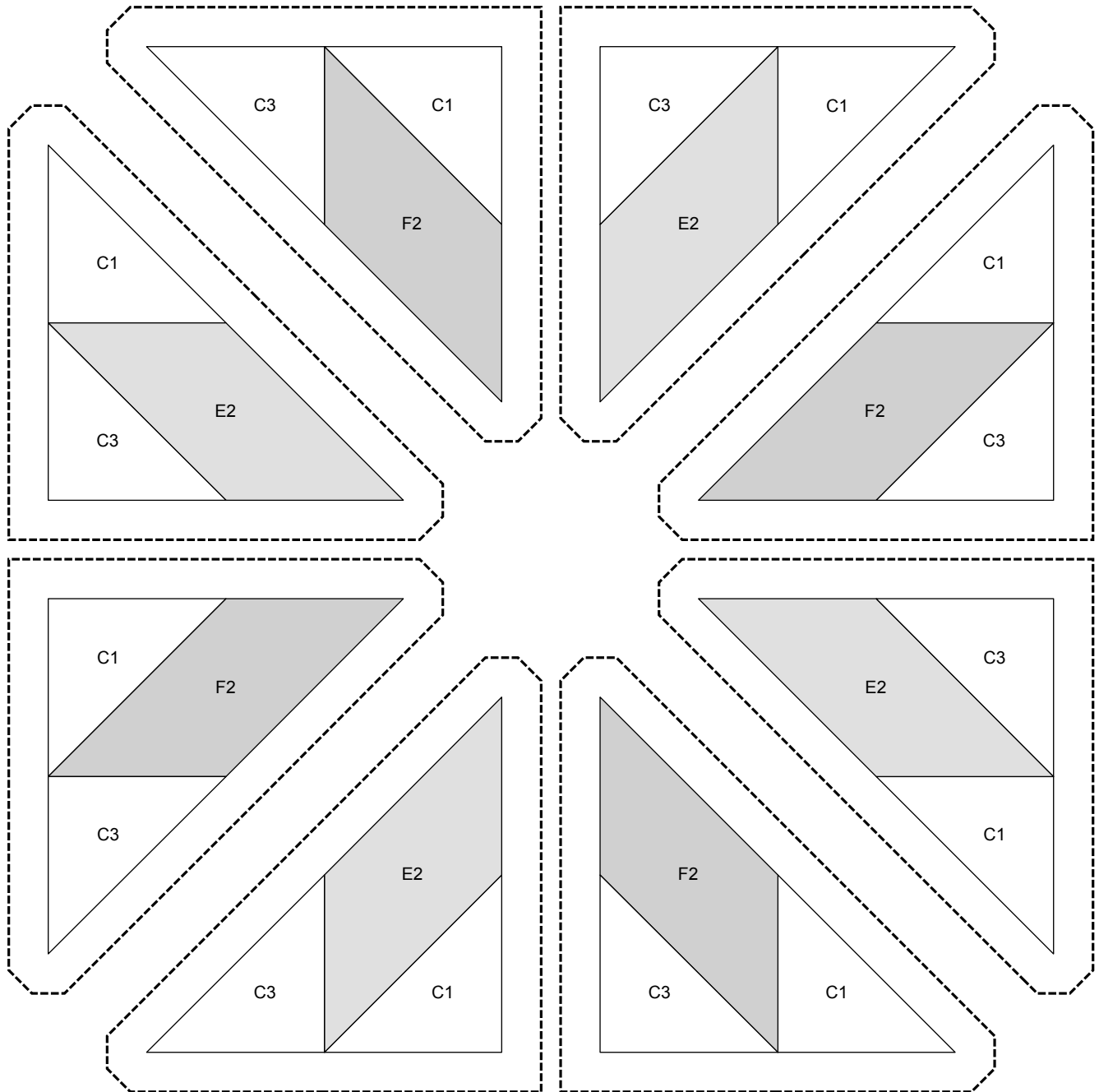

## The Jane Stickle Quilt - Block G9

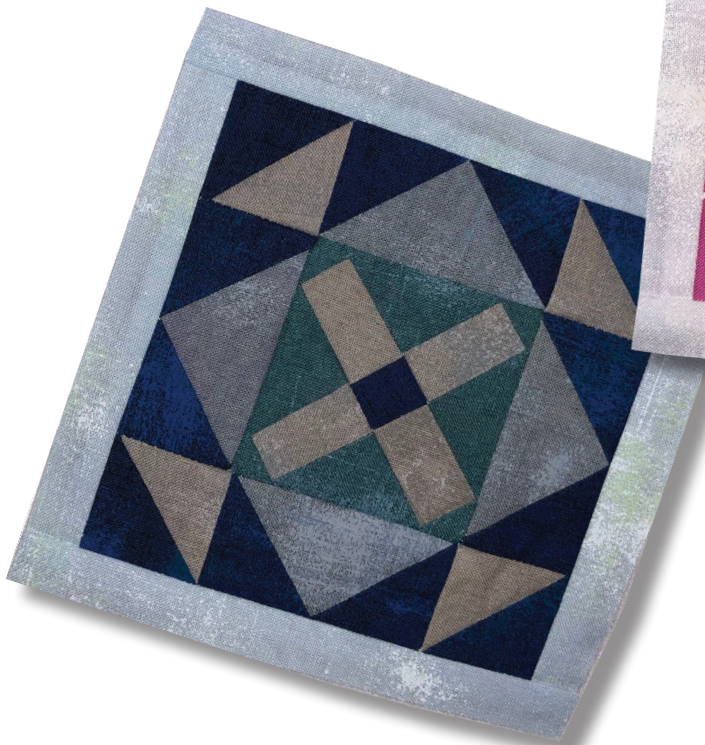

### What you need:

Patches	Quantity/size
A*	(2) 1" x 6"
B*	(2) 1" x 5"
C	(6) 2½" x 2½" - navy, cut once diagonally (2) 2½" x 2½" - beige, cut once diagonally
D	(1) 4" x 4" - gray, cut twice diagonally
E	(2) 2" x 2", cut once diagonally
F	(1) 3" x 3", cut twice diagonally
G	(4) 1½" x 2"
H	(1) 1½" x 1½"

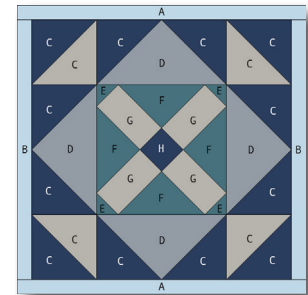

*Hobbystash Colorway*

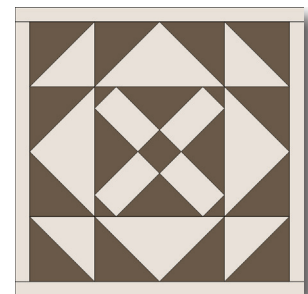

*Jane Stickle Colorway*

*\*The actual required width for Unit A and Unit B units is ¾". The increased width specified above allows for squaring the block to exactly 5½".*

### Assembly:

1. Using templates on Page G9-2, foundation piece sections.
2. Assemble sections and sew together.
3. Join Unit B to the right side of the block, and then the left.
4. Join Unit A to the top of the block and then the bottom. Square up block to measure 5½" x 5½" square.

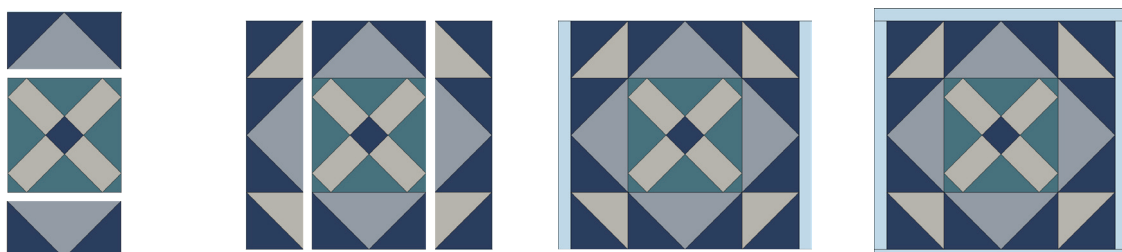

SET PRINTER TO "ACTUAL SIZE" WHEN PRINTING THIS PAGE.

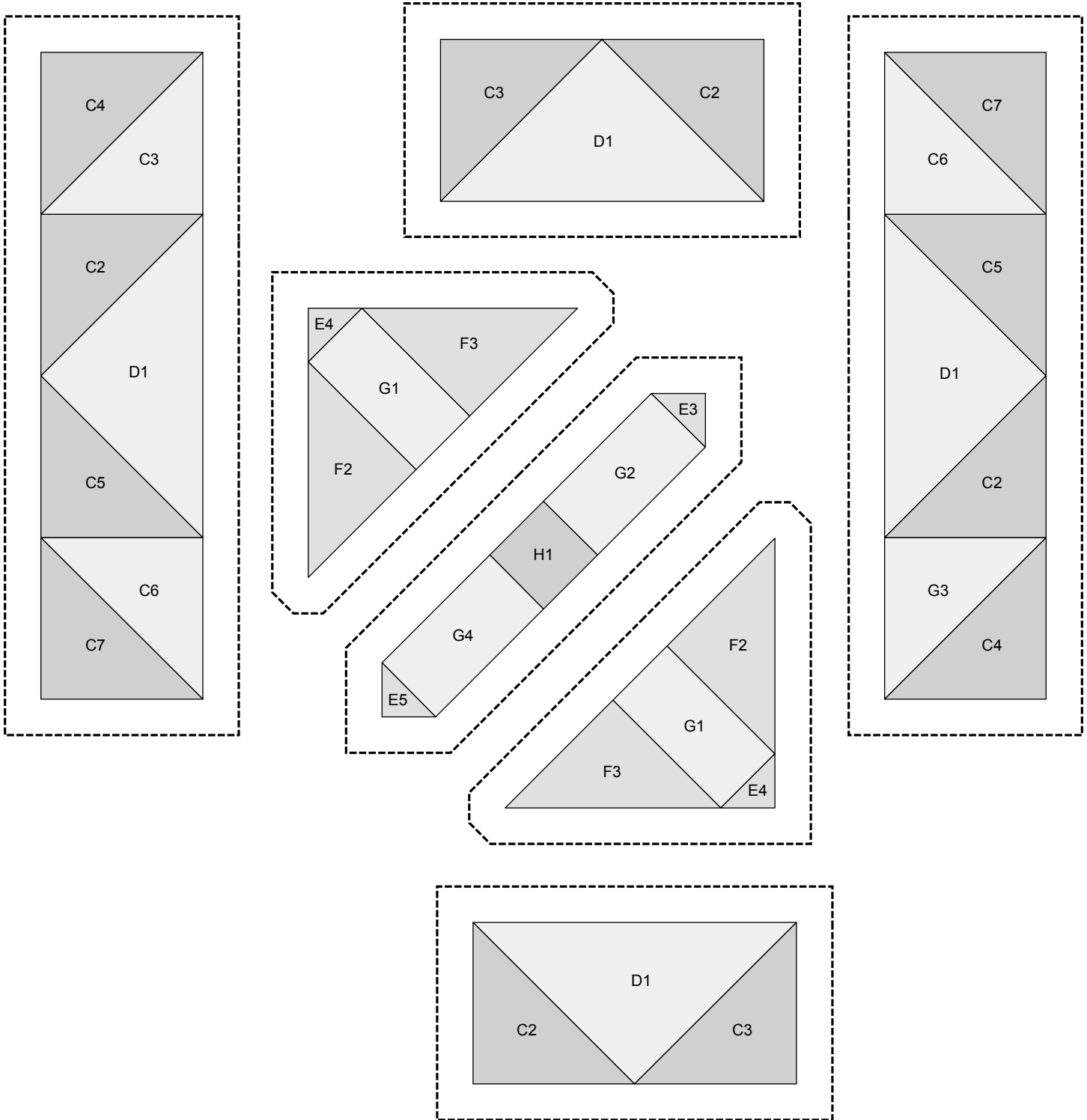

2"

SET PRINTER TO "ACTUAL SIZE" WHEN PRINTING THIS PAGE.

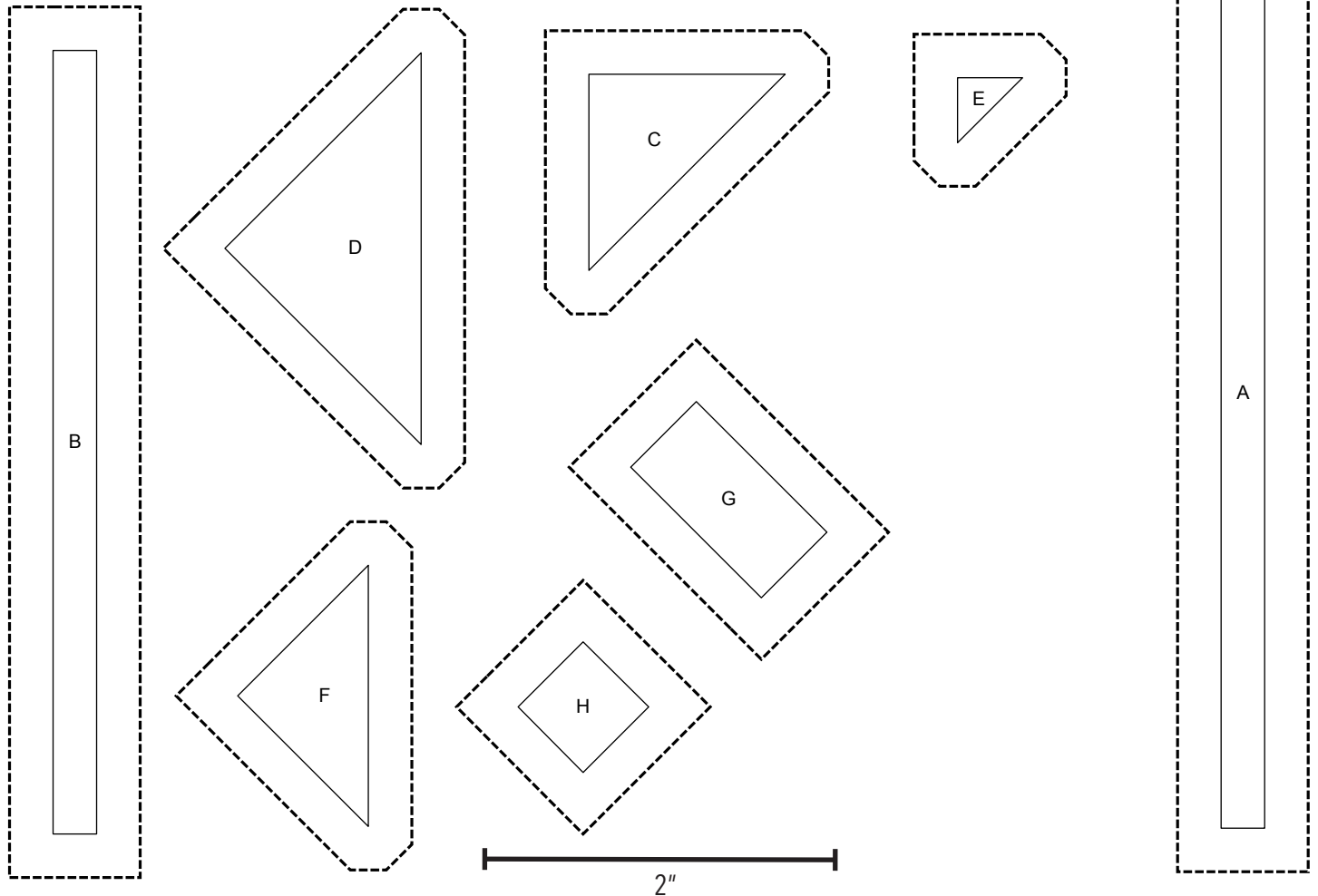
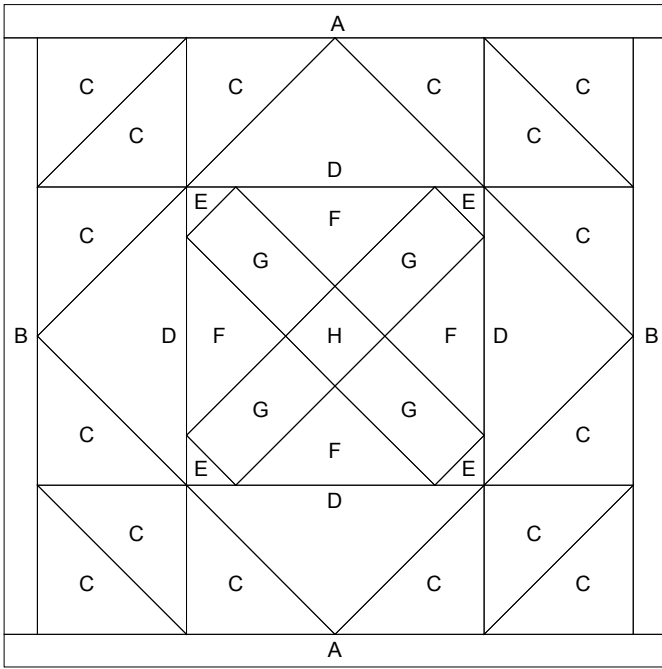



## The Jane Stickle Quilt - Block G10

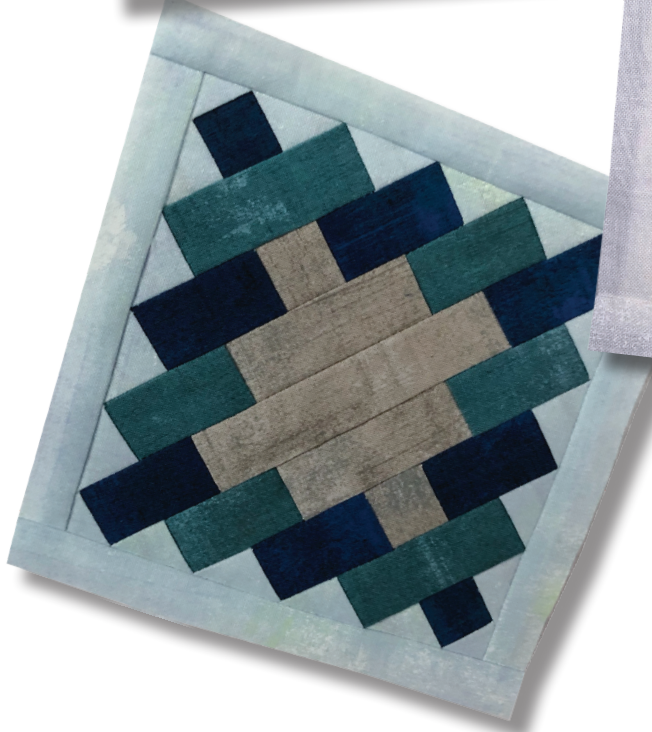

### What you need:

Patches	Quantity/size
A*	(2) 1" x 6"
B*	(2) 1" x 5"
C	(2) 2" x 2", cut once diagonally
D	(4) 3" x 3", cut twice diagonally
E	(2) 1½" x 1½" - navy (2) 1½" x 1½" - beige
F	(2) 1½" x 3" - green (2) 1½" x 3" - beige
G	(6) 1½" x 2" - navy (4) 1½" x 2" - green
H	(1) 1½" x 4" - beige

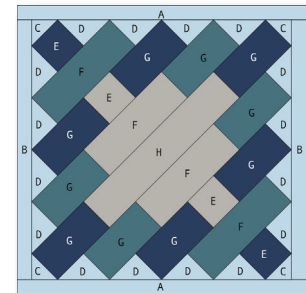

*Hobbystash Colorway*

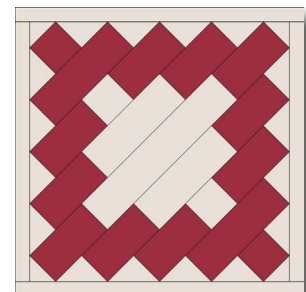

*Jane Stickle Colorway*

*\*The actual required width for Unit A and Unit B units is ¾". The increased width specified above allows for squaring the block to exactly 5½".*

### Assembly:

1. Using templates on Page G10-2, foundation piece sections.
2. Assemble sections and sew together.
3. Join Unit B to the right side of the block, and then the left.
4. Join Unit A to the top of the block and then the bottom. Square up block to measure 5½" x 5½" square.

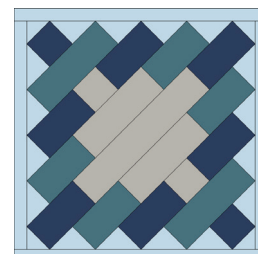
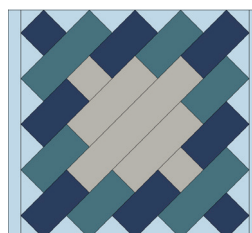
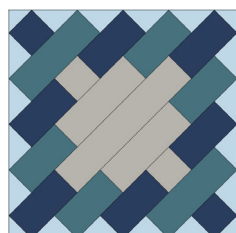

SET PRINTER TO "ACTUAL SIZE" WHEN PRINTING THIS PAGE.

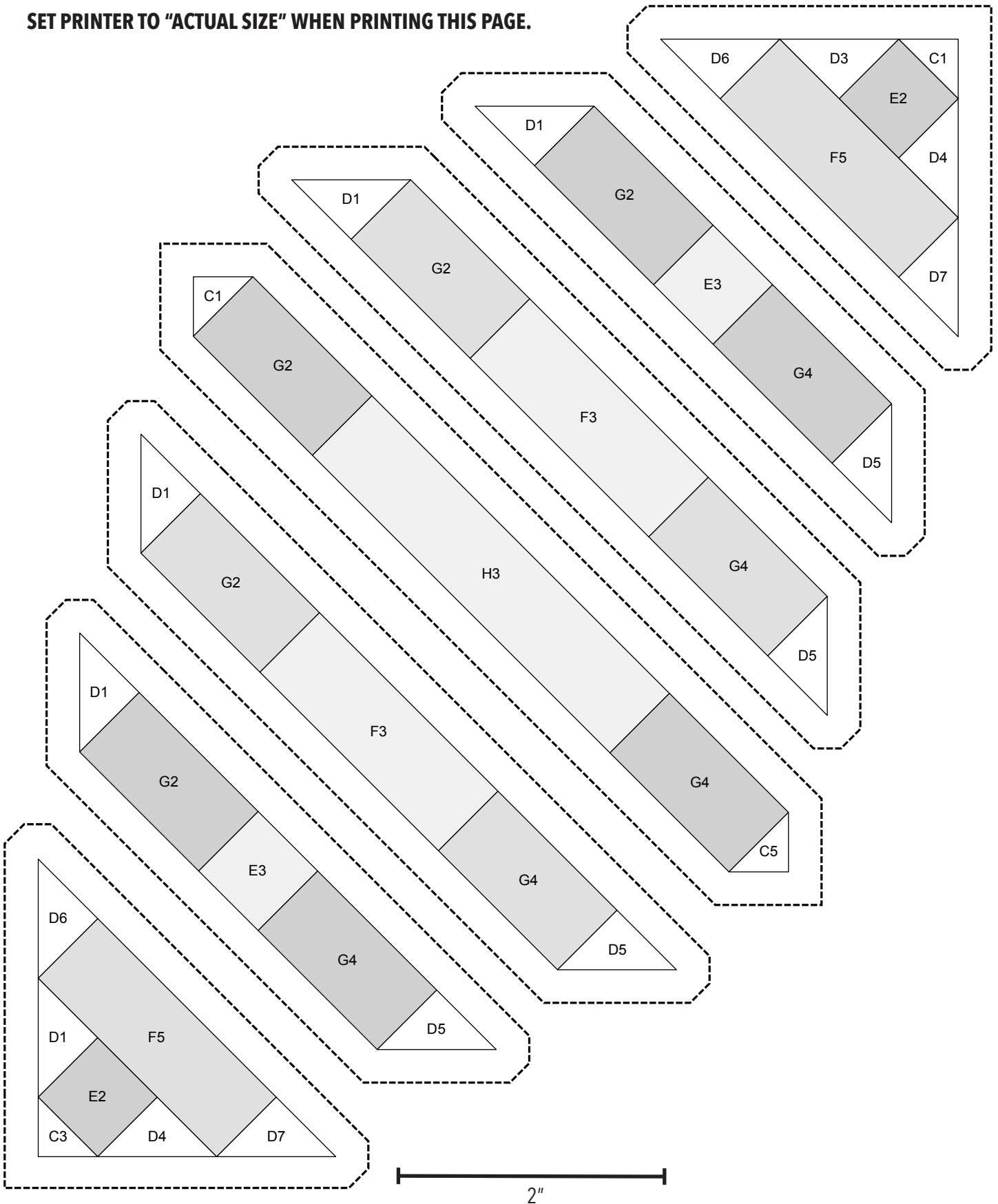

SET PRINTER TO "ACTUAL SIZE" WHEN PRINTING THIS PAGE.

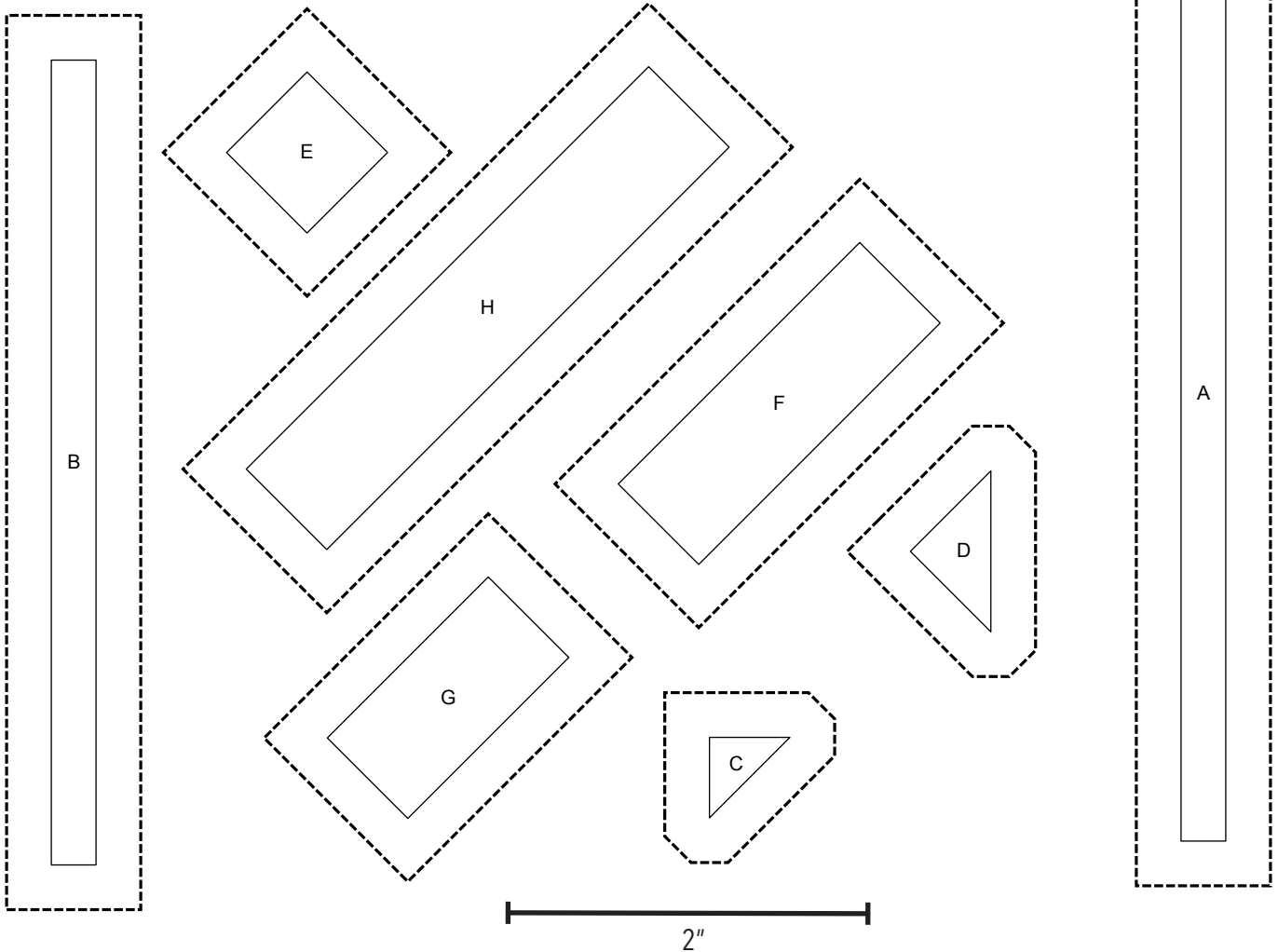
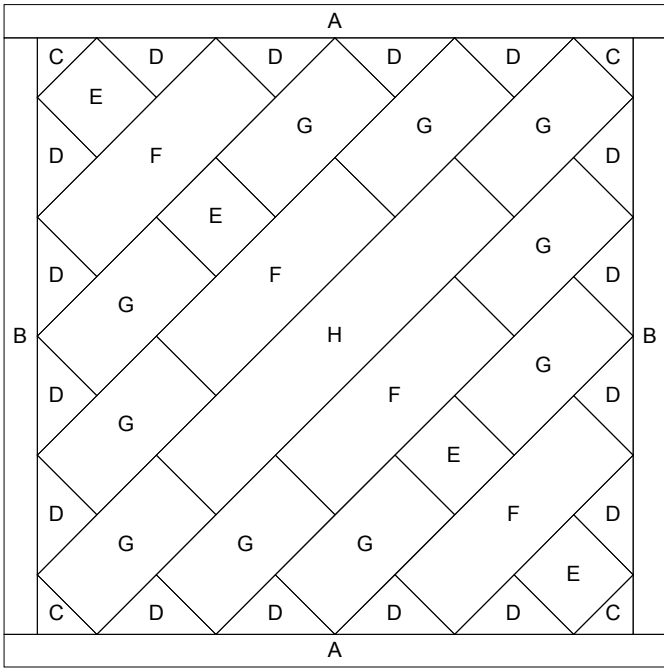

## The Jane Stickle Quilt - Block G11



### What you need:

Patches	Quantity/size
A*	(2) 1" x 6"
B*	(2) 1" x 5"
C	(4) 1¾" x 1¾"
D	(8) 1¾" x 1¾"
E 	(4) 1¾" x 3, cut one diagonally
F	(1) 2½" x 2½"
G	(4) 1½" x 2½"

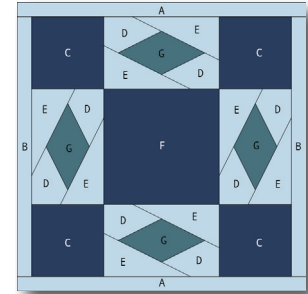

Hobbystash Colorway

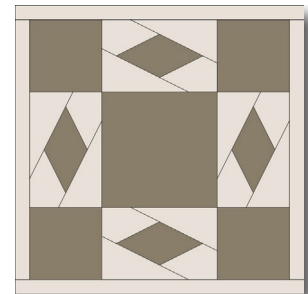

Jane Stickle Colorway

*\*The actual required width for Unit A and Unit B units is ¾". The increased width specified above allows for squaring the block to exactly 5½".*

### Assembly:

- Using templates on Page G11-2, foundation piece diamond sections.
- Sew a Unit C to each end of two Step 1 diamond patches.
- Sew the remaining two Step 1 patches to opposite sides of Unit F.
- Arrange the rows created in Step 2 and Step 3 as shown and sew together.
- Join Unit B to the right side of the block, and then the left.
- Join Unit A to the top of the block and then the bottom. Square up block to measure 5½" x 5½" square.

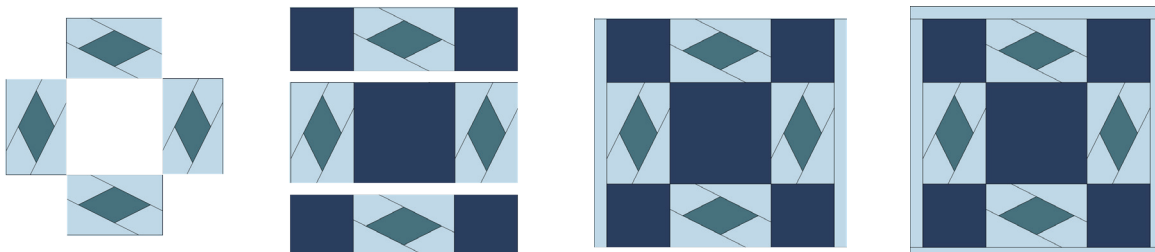

SET PRINTER TO "ACTUAL SIZE" WHEN PRINTING THIS PAGE.

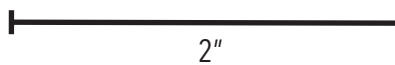
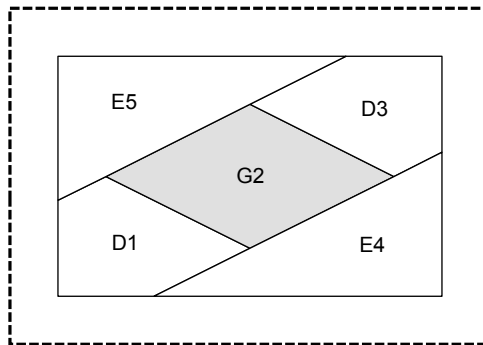
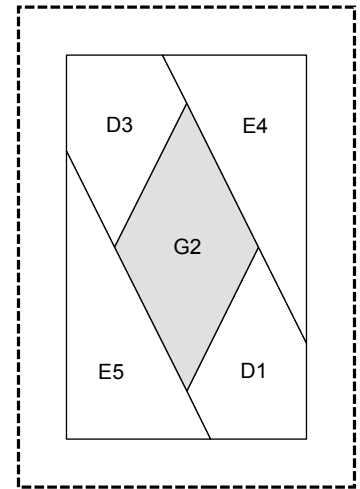
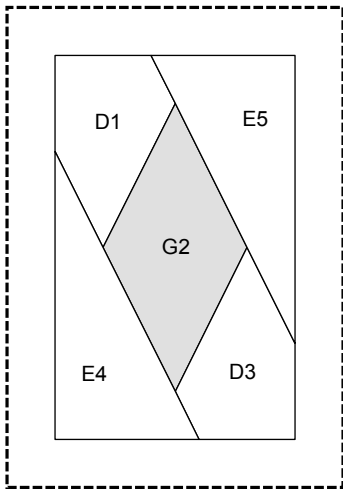
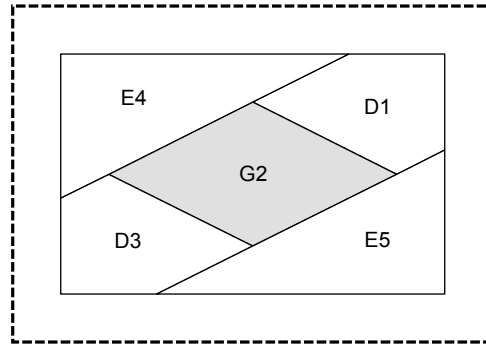

SET PRINTER TO "ACTUAL SIZE" WHEN PRINTING THIS PAGE.

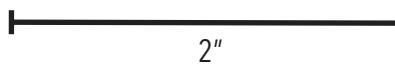
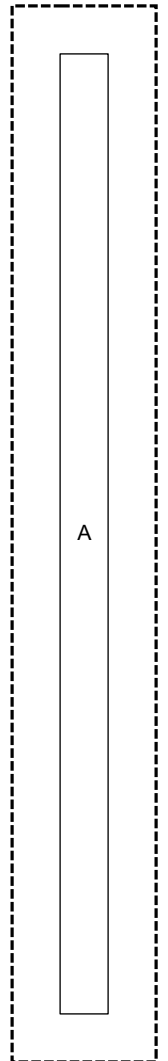
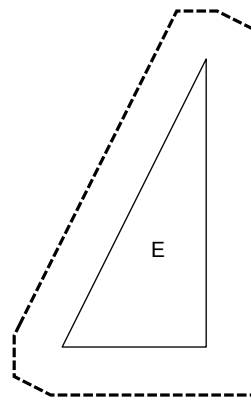
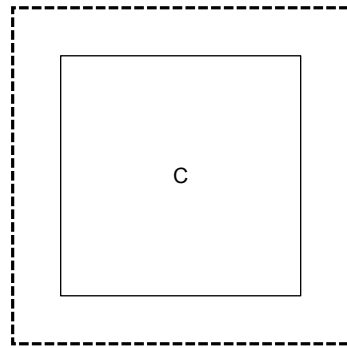
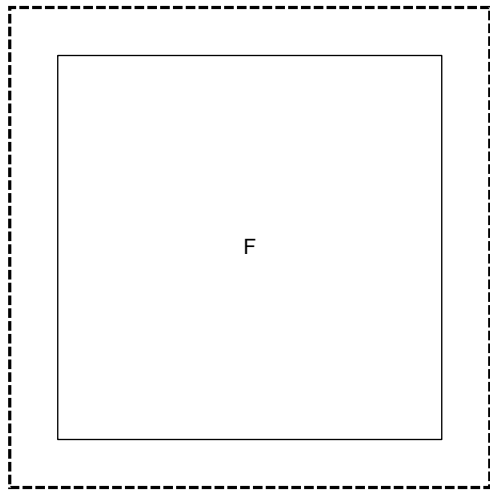
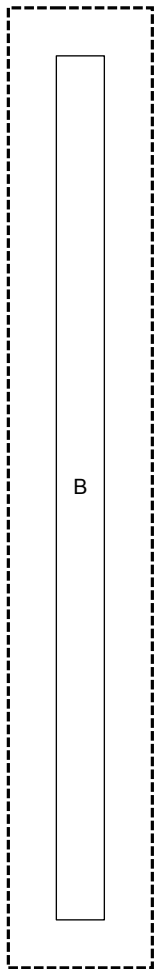
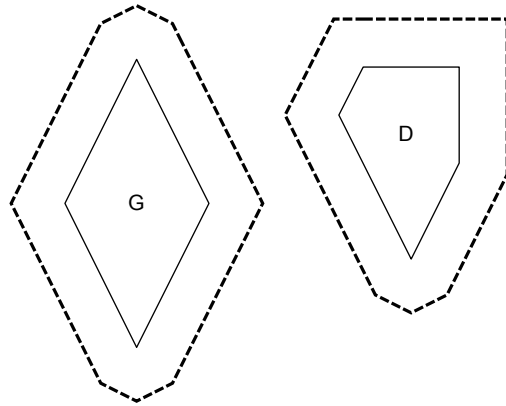
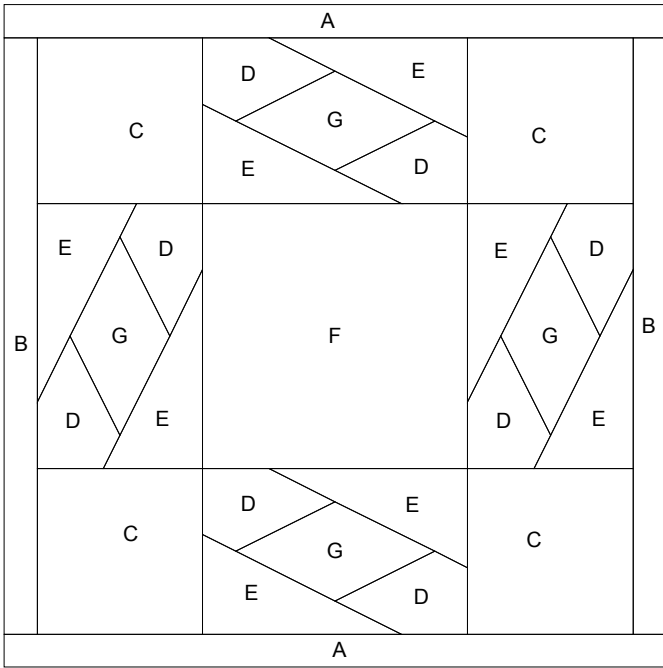



## The Jane Stickle Quilt - Block G12

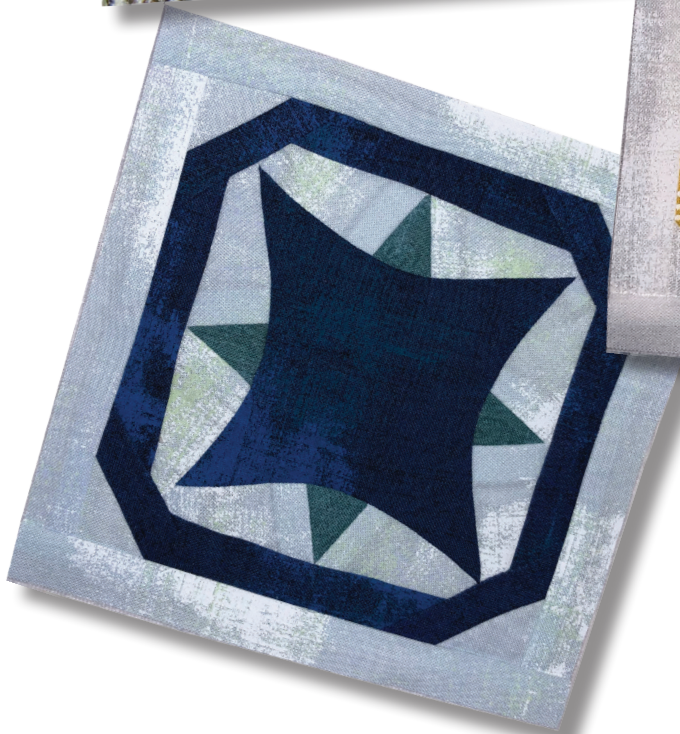

### What you need:

Patches	Quantity/size
A*	(2) 1" x 6"
B*	(2) 1" x 5"
C	(2) 2" x 2", cut once diagonally
D	(4) 1¼" x 3¼"
E	(4) 1¼" x 4¼"
F	(4) 2" x 3"
G	(4) 2" x 3"
H	(1) 5" x 5"
I	(4) 2" x 2"

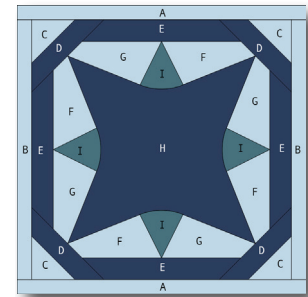

Hobbystash Colorway

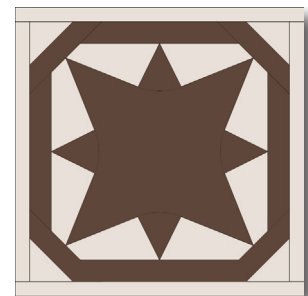

Jane Stickle Colorway

*\*The actual required width for Unit A and Unit B units is ¾". The increased width specified above allows for squaring the block to exactly 5½".*

### Assembly:

1. Using templates on Page G12-2, foundation piece sections.
2. Assemble sections and sew together.
3. Join Unit B to the right side of the block, and then the left.
4. Join Unit A to the top of the block and then the bottom. Square up block to measure 5½" x 5½" square.

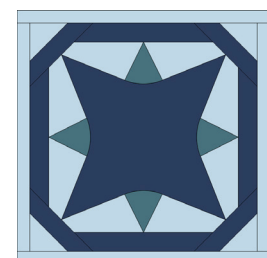
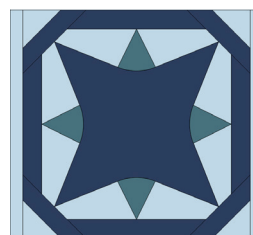

SET PRINTER TO "ACTUAL SIZE" WHEN PRINTING THIS PAGE.

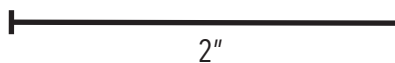
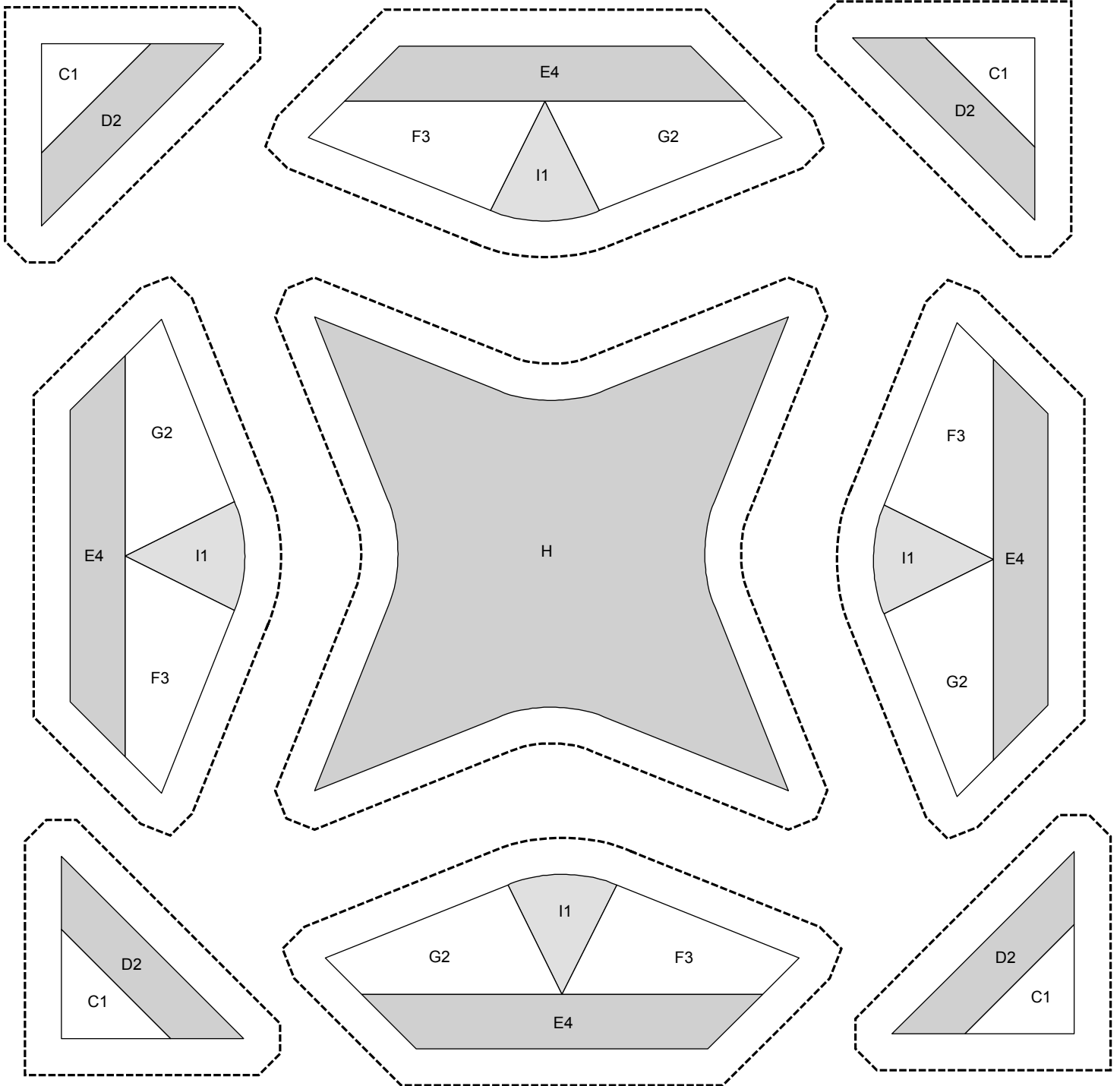

SET PRINTER TO "ACTUAL SIZE" WHEN PRINTING THIS PAGE.

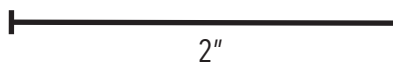
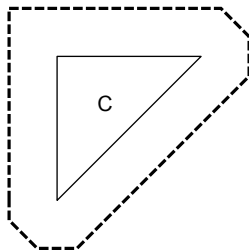
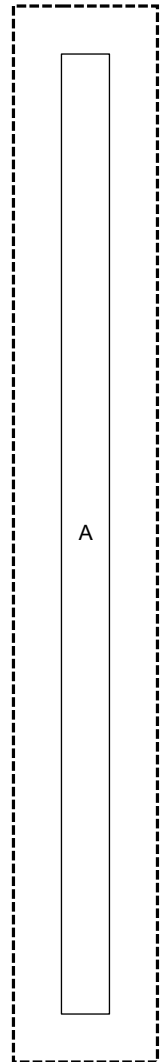
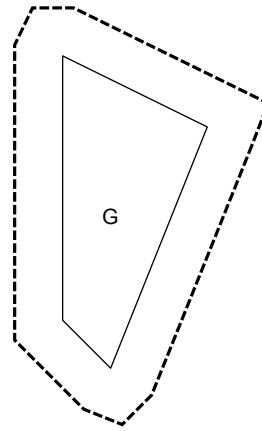
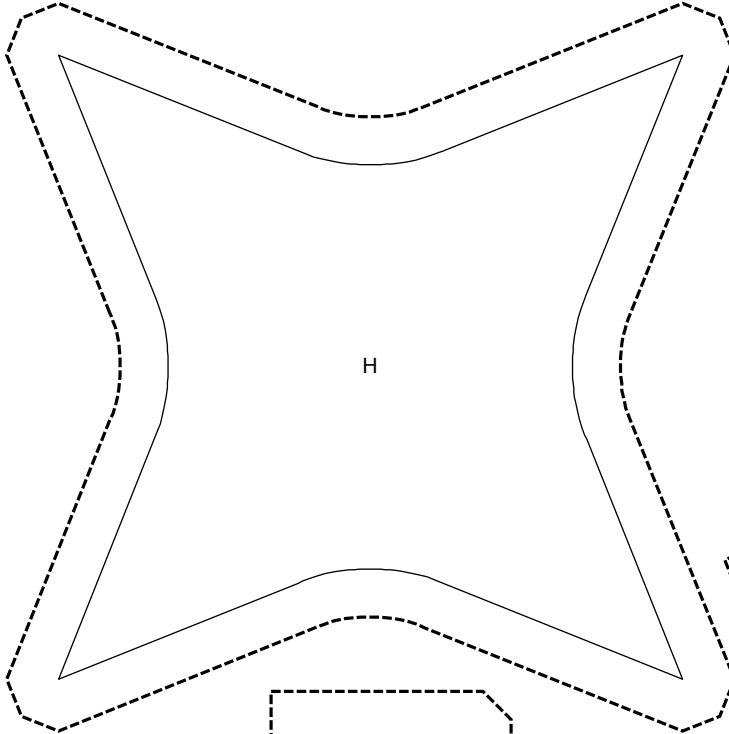
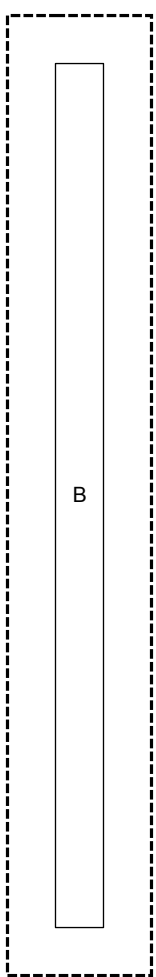
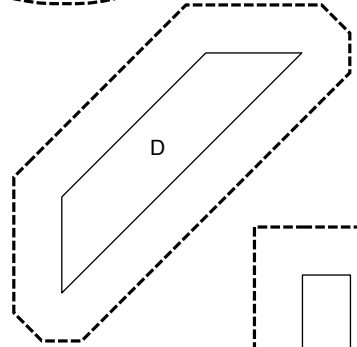
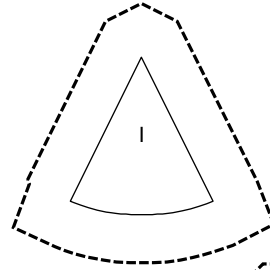
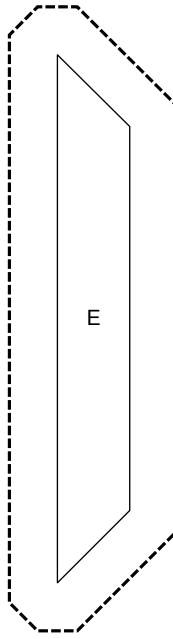
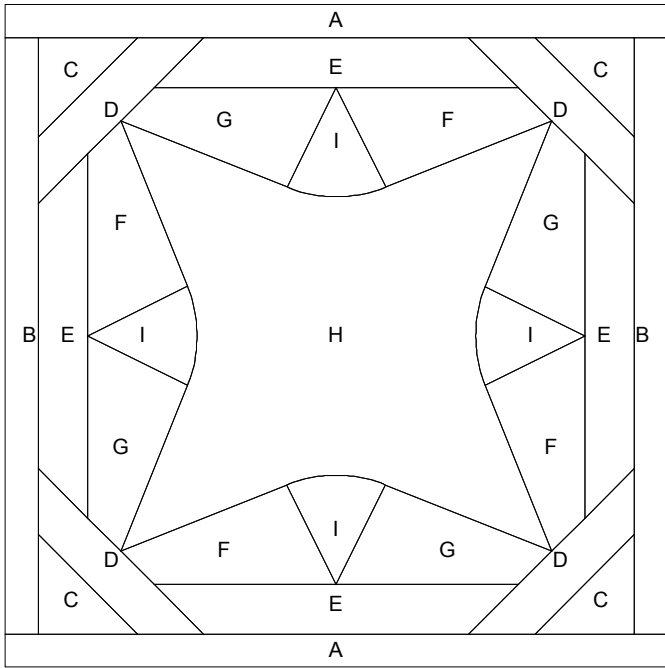

## The Jane Stickle Quilt - Block G13

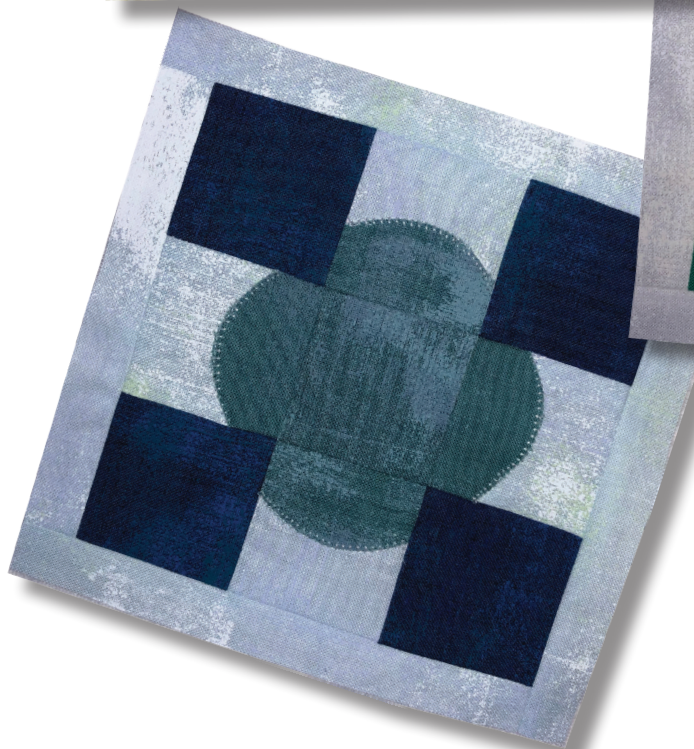

### What you need:

Patches	Quantity/size
A*	(2) 1" x 6"
B*	(2) 1" x 5"
C	(4) 2" x 2" - navy (1) 2" x 2" - green
D	(4) 2" x 2" - light blue
E	(4) 2" x 2" - green

*\*The actual required width for Unit A and Unit B units is ¾". The increased width specified above allows for squaring the block to exactly 5½".*

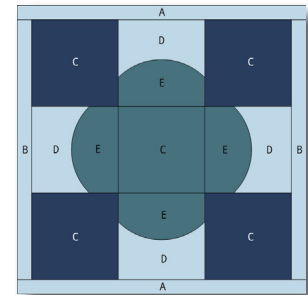

*Hobbystash Colorway*

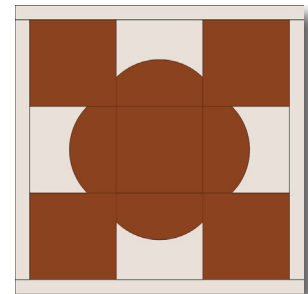

*Jane Stickle Colorway*

### Assembly:

- Using templates on Page G13-2, curve piece or appliqué Unit E to Unit D. Make 4.
- Sew navy Unit C to each side of two Step 1 patches.
- Sew remaining Step 1 patches to each side of remaining green Unit C.
- Arrange rows from Step 2 and Step 3 as shown and sew together.
- Join Unit B to the right side of the block, and then the left.
- Join Unit A to the top of the block and then the bottom. Square up block to measure 5½" x 5½" square.

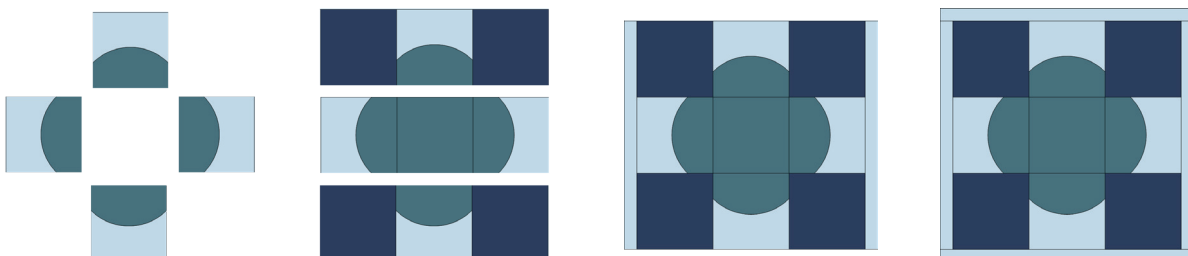

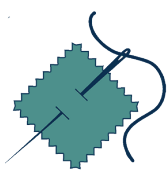

SET PRINTER TO "ACTUAL SIZE" WHEN PRINTING THIS PAGE.

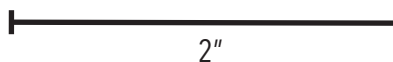
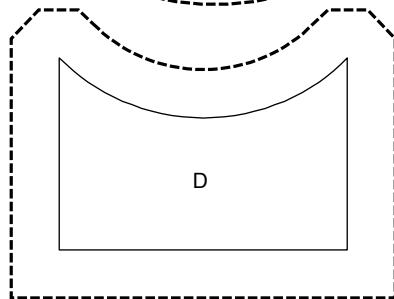
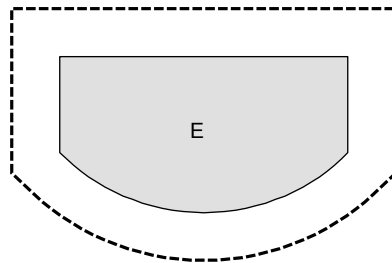
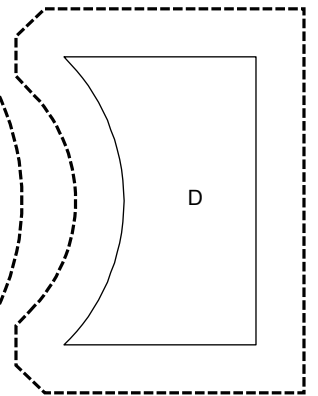
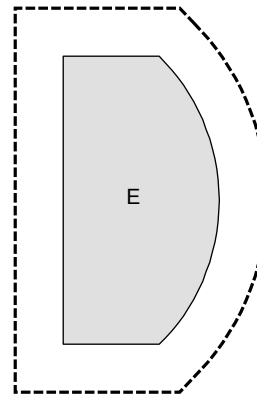
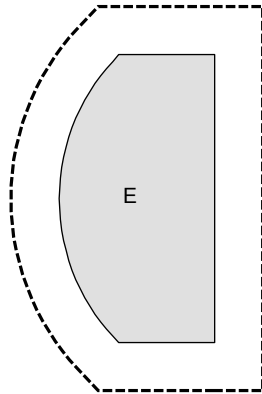
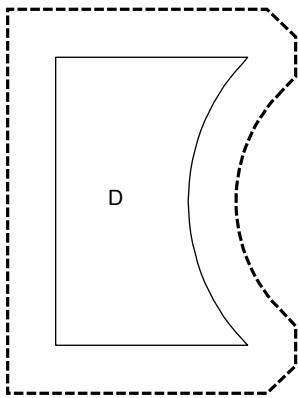
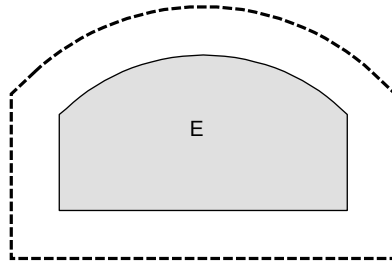
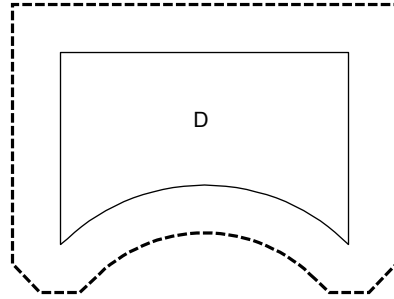

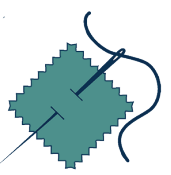

SET PRINTER TO "ACTUAL SIZE" WHEN PRINTING THIS PAGE.

