

## The Jane Stickle Quilt - Block G7

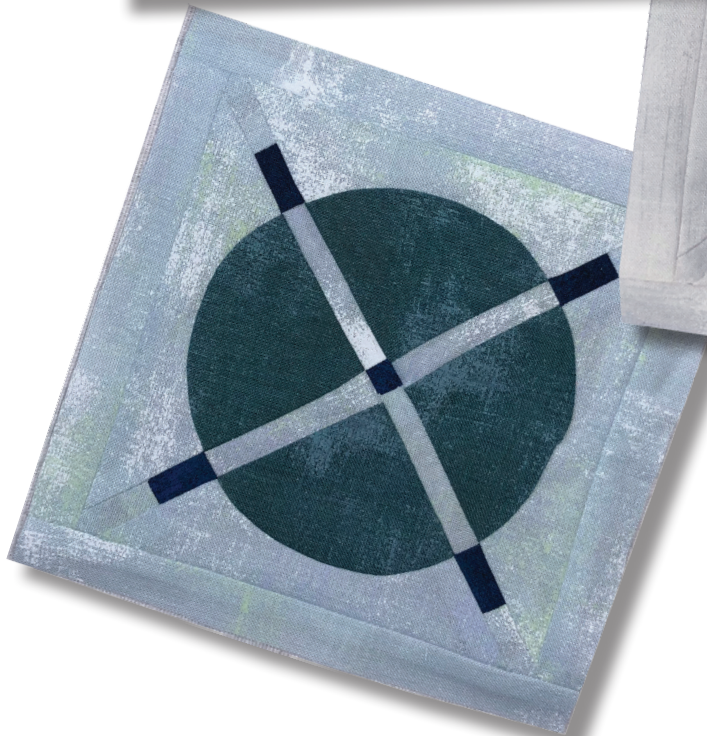

### What you need:

Patches	Quantity/size
A*	(2) 1" x 6"
B*	(2) 1" x 5"
C	(4) 1" x 2"
D	(1) 6" x 6", cut twice diagonally
E	(4) 1" x 1½"
F	(4) 1" x 2½"
G	(1) 5½" x 5½", cut twice diagonally
H	(1) 1" x 1"

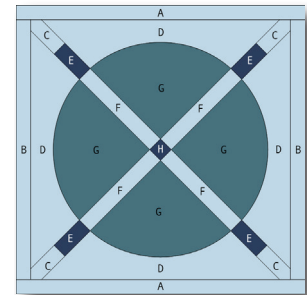

Hobbystash Colorway

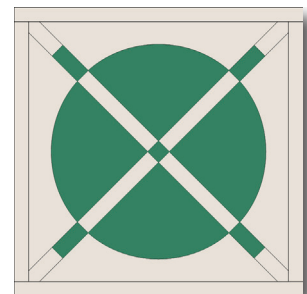

Jane Stickle Colorway

*\*The actual required width for Unit A and Unit B units is ¾". The increased width specified above allows for squaring the block to exactly 5½".*

### Assembly:

- Using templates on Page G7-2 and G7-3, curve piece or appliqué Unit G to Unit D. Make 4.
- Using templates on Page G7-4, foundation piece remaining sections of block.
- Assemble sections from Step 1 and Step 2. Sew together.
- Join Unit B to the right side of the block, and then the left.
- Join Unit A to the top of the block and then the bottom. Square up block to measure 5½" x 5½" square.

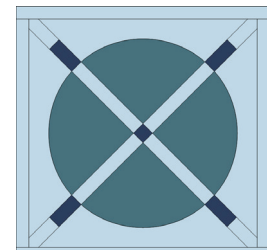
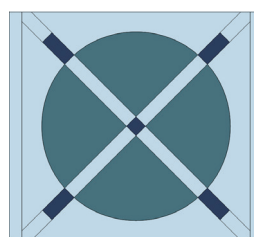
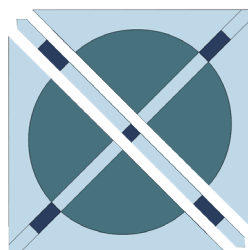
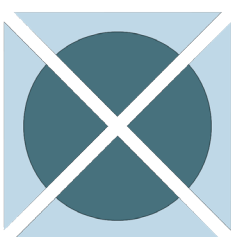

SET PRINTER TO "ACTUAL SIZE" WHEN PRINTING THIS PAGE.

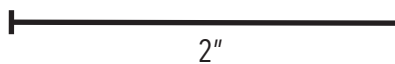
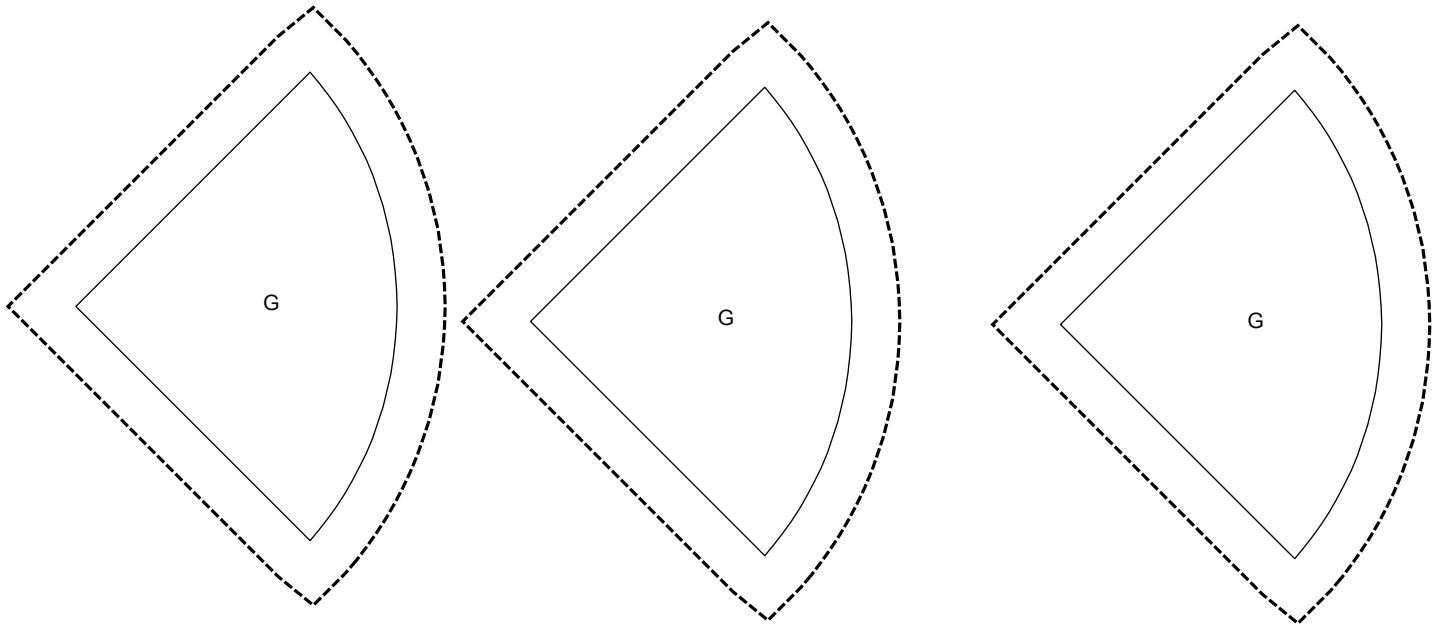
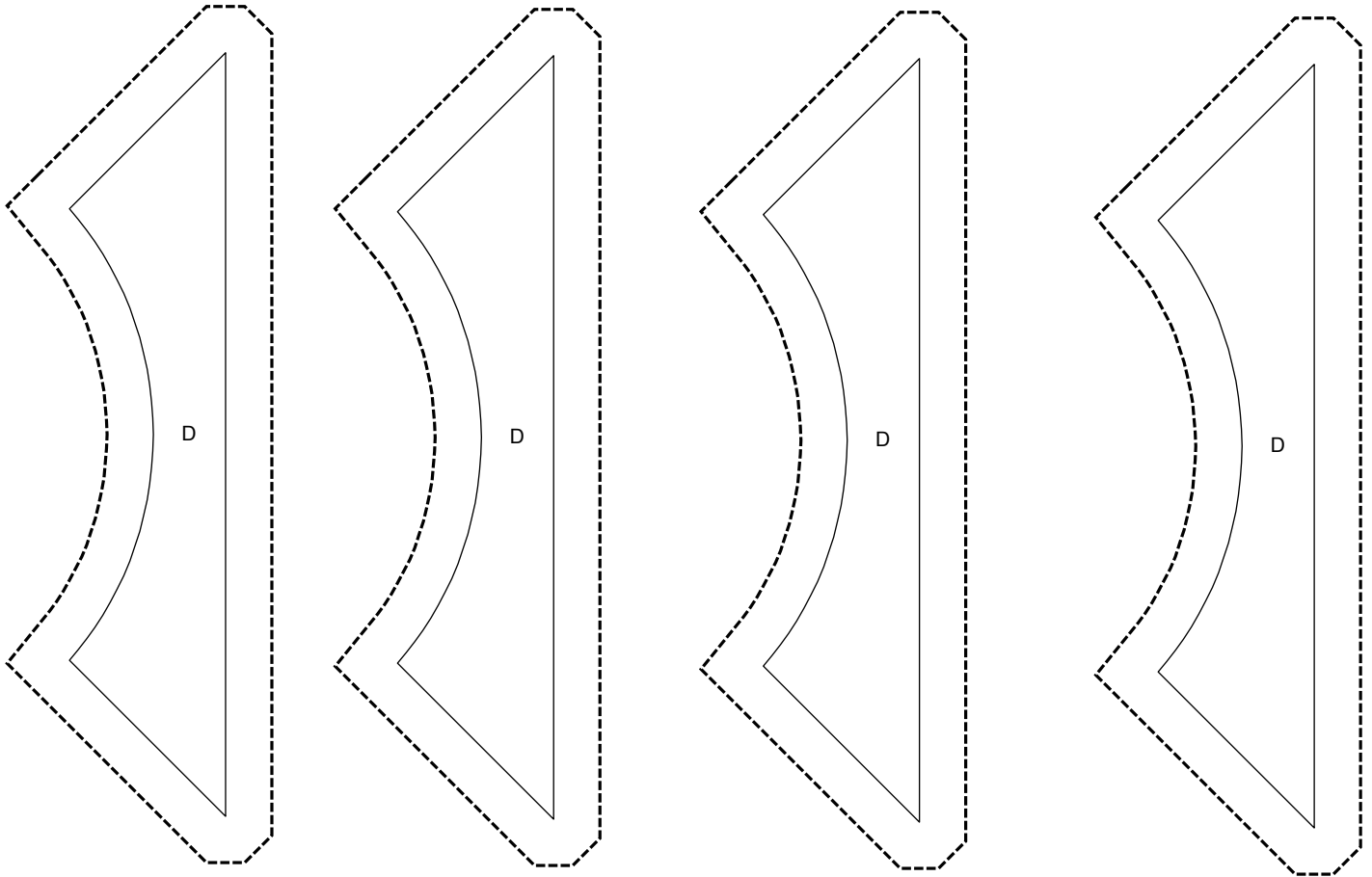

SET PRINTER TO "ACTUAL SIZE" WHEN PRINTING THIS PAGE.

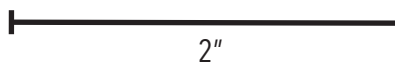
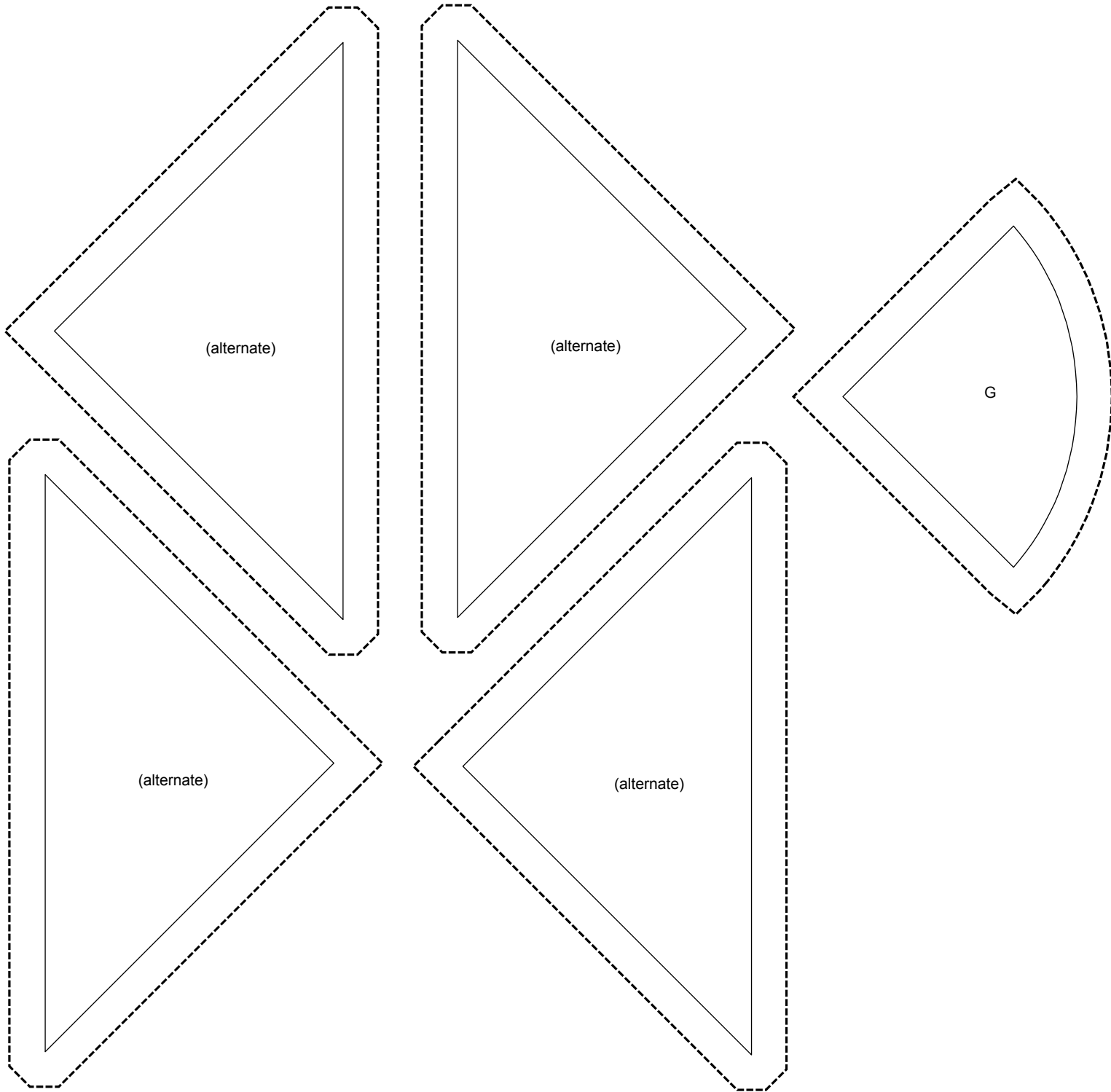

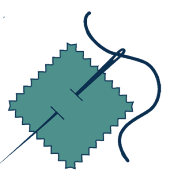

SET PRINTER TO "ACTUAL SIZE" WHEN PRINTING THIS PAGE.

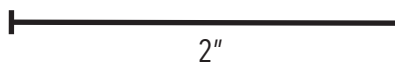
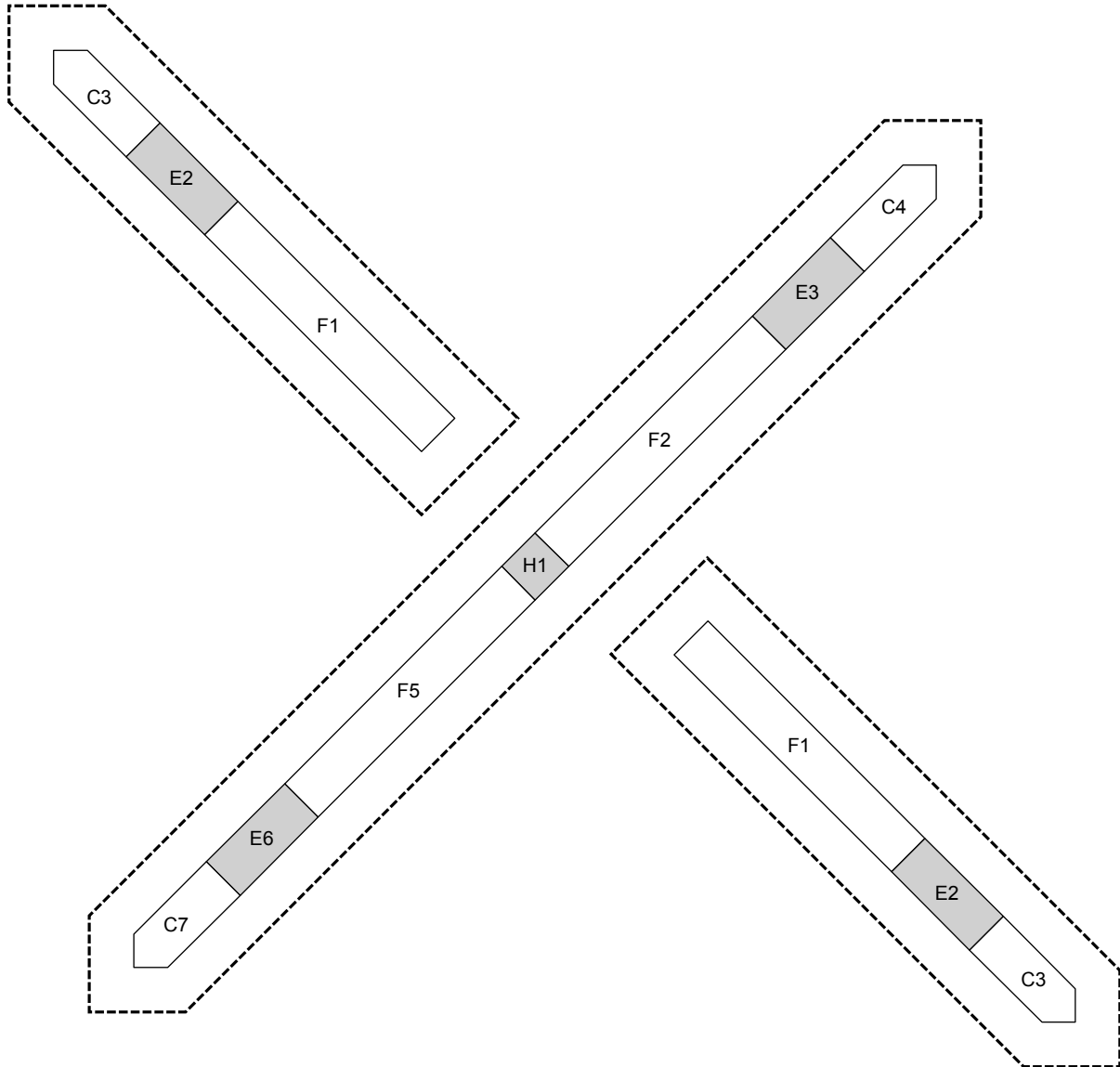

SET PRINTER TO "ACTUAL SIZE" WHEN PRINTING THIS PAGE.

