

## The Jane Stickle Quilt - Block G5



### What you need:

Patches	Quantity/size
A*	(2) 1" x 6"
B*	(2) 1" x 5"
C	(2) 1¼" x 4"
D	(1) 5½" x 5½", cut twice diagonally
E	(1) 1¼" x 7¼"
F	(1) 4" x 4"

*\*The actual required width for Unit A and Unit B units is ¾". The increased width specified above allows for squaring the block to exactly 5½".*

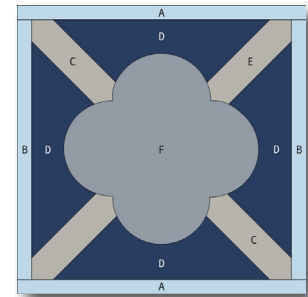

*Hobbystash Colorway*

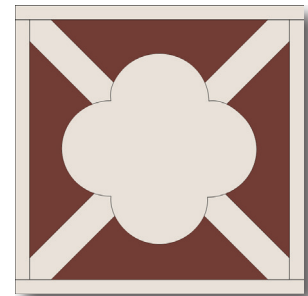

*Jane Stickle Colorway*

### Assembly:

1. Using templates on Page G5-2, foundation piece sections.
2. Assemble sections and sew together.
3. Using the template provided on Page G5-2, appliqué Unit F clover to Step 2 patch.
4. Join Unit B to the right side of the block, and then the left.
5. Join Unit A to the top of the block and then the bottom. Square up block to measure 5½" x 5½" square.

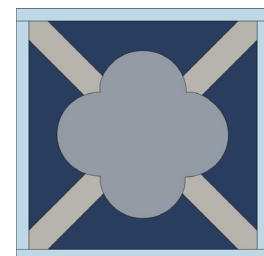
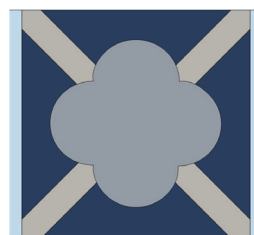

SET PRINTER TO "ACTUAL SIZE" WHEN PRINTING THIS PAGE.

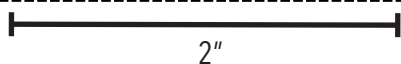
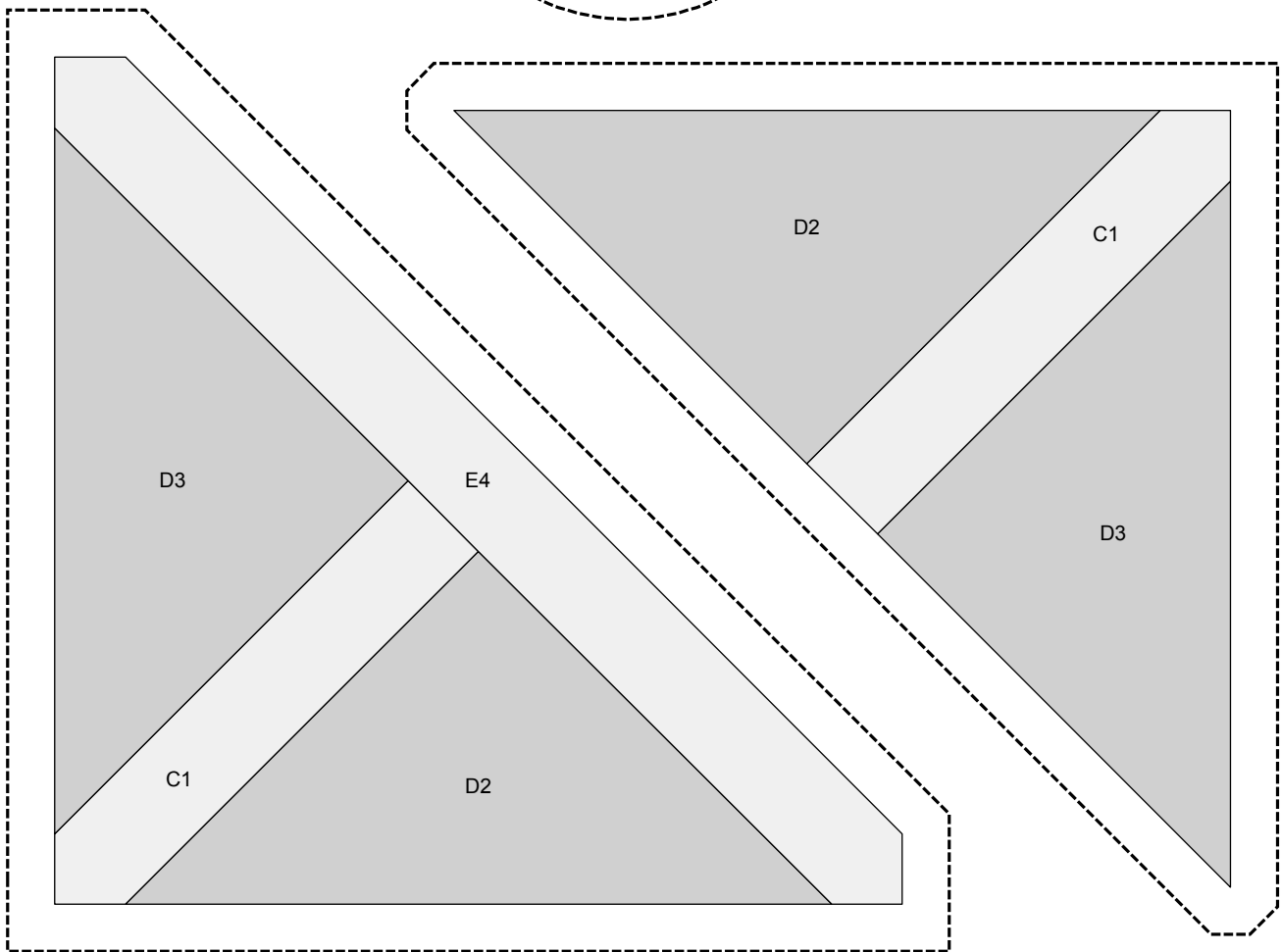
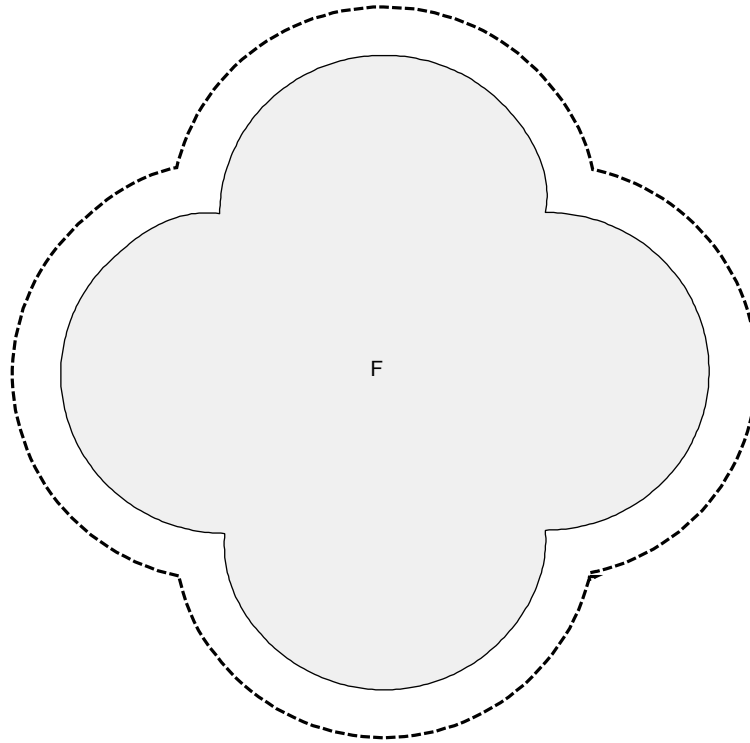

SET PRINTER TO "ACTUAL SIZE" WHEN PRINTING THIS PAGE.

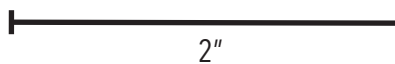
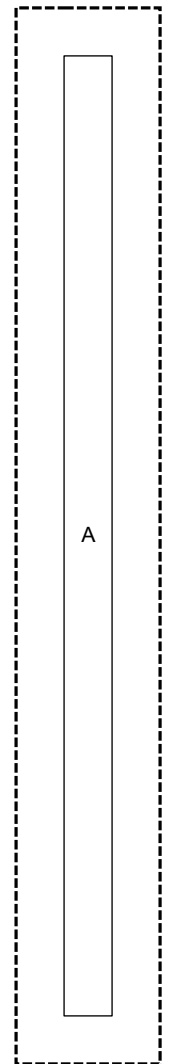
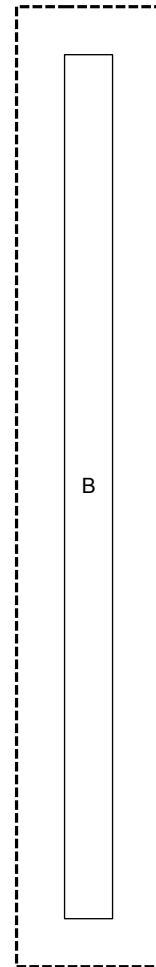
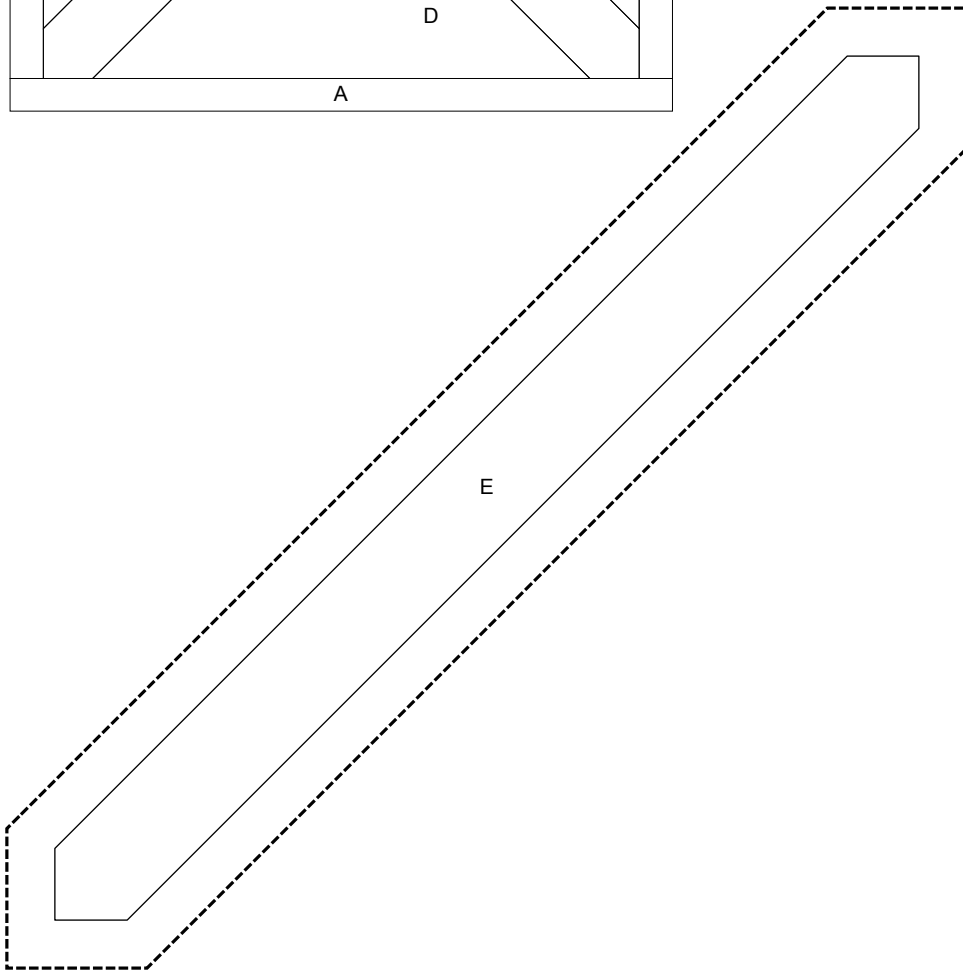
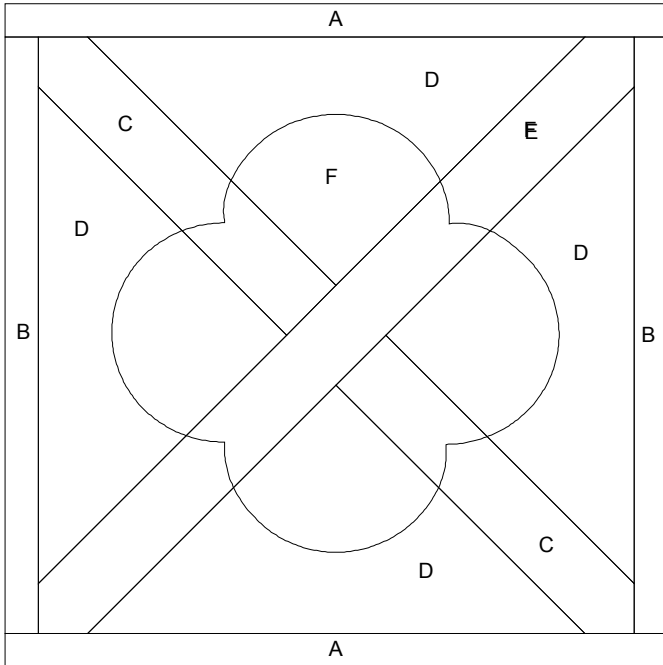

SET PRINTER TO "ACTUAL SIZE" WHEN PRINTING THIS PAGE.

