

The Jane Stickle Quilt - Row F

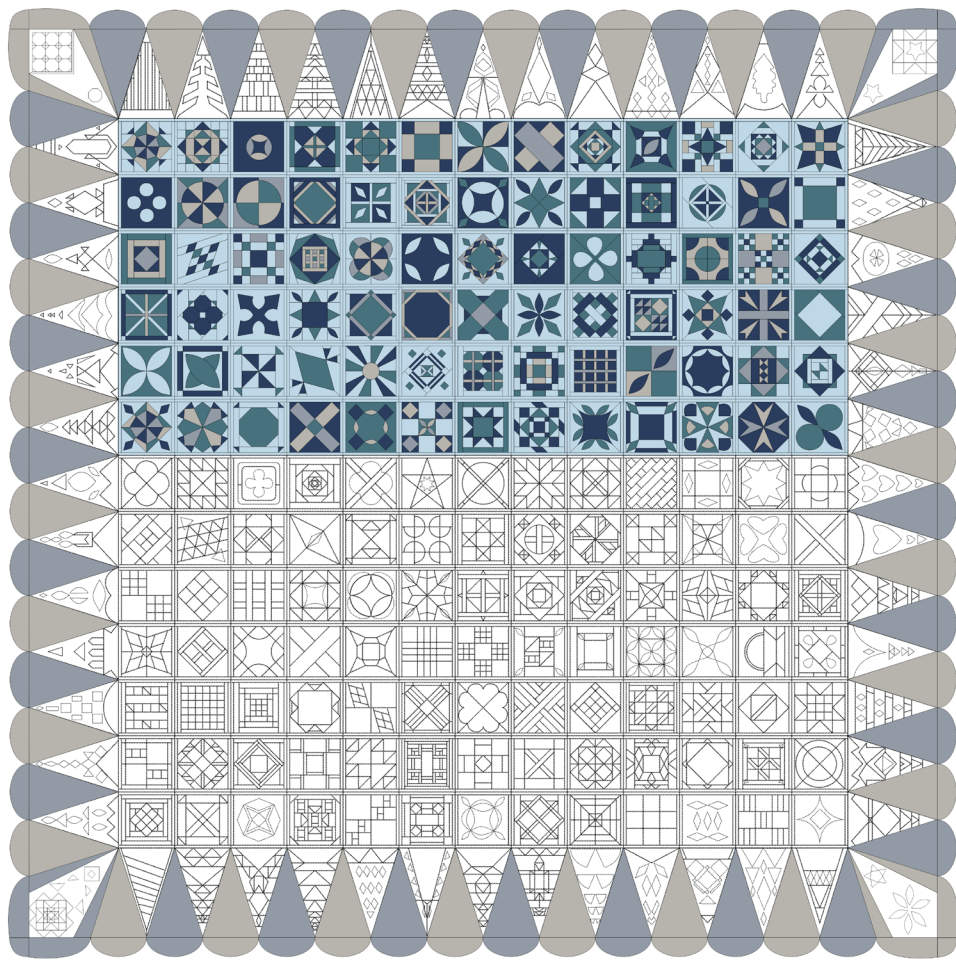

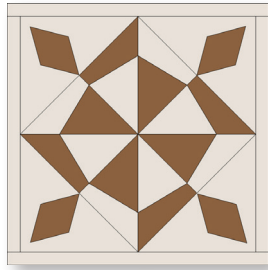

F1

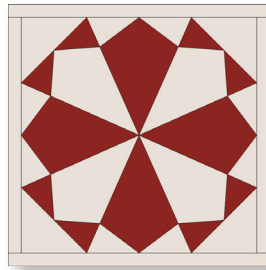

F2

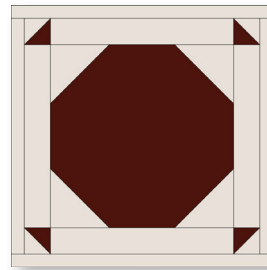

F3

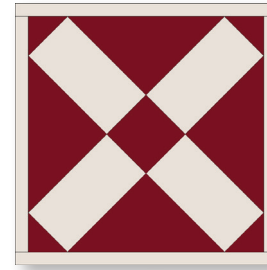

F4

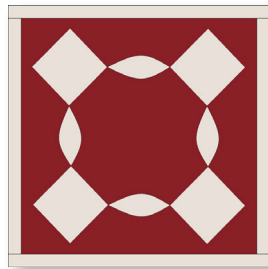

F5

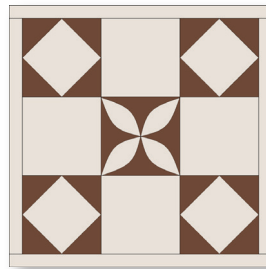

F6

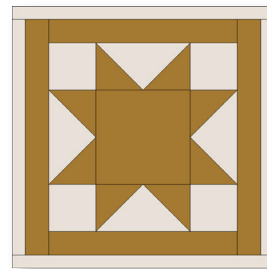

F7

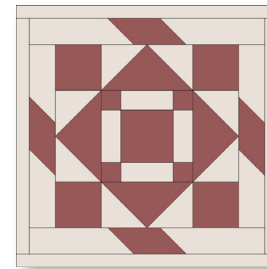

F8

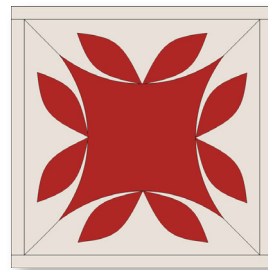

F9

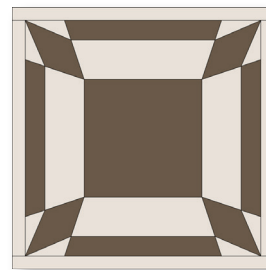

F10

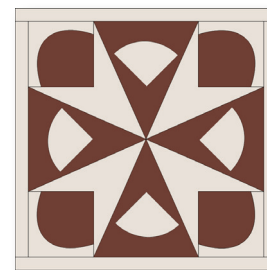

F11

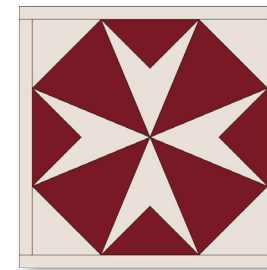

F12

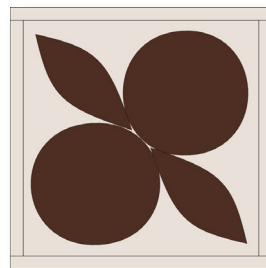

F13

The Jane Stickle Quilt - Block F1

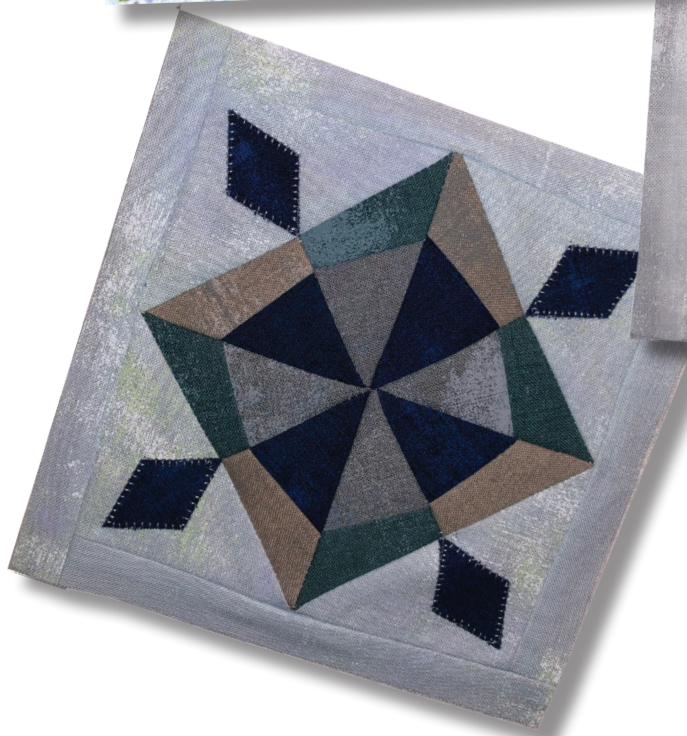

What you need:

Patches	Quantity/size
A*	(2) 1" x 6"
B*	(2) 1" x 5"
C	(2) 3½" x 3½", cut once diagonally
D	(4) 1½" x 3"
E	(4) 2" x 3"
F	(4) 2" x 3"
G	(4) 1½" x 3"
H	(4) 1½" x 2"

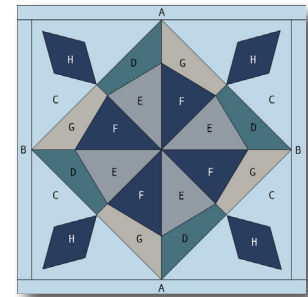

Hobbystash Colorway

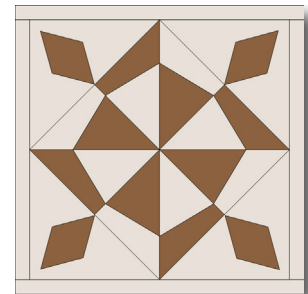

Jane Stickle Colorway

**The actual required width for Unit A and Unit B units is ¾". The increased width specified above allows for squaring the block to exactly 5½".*

Assembly:

1. Using the templates provided on Page F1-2, foundation piece the sections of the block.
2. Assemble the sections and sew together.
3. Using the templates provided on Page F1-3, appliqué four Unit H diamonds to the corners of the block.
4. Join Unit B to the right side of the block, and then the left.
5. Join Unit A to the top of the block and then the bottom. Square up block to measure 5½" x 5½" square.

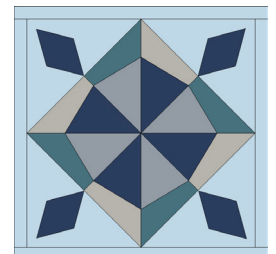
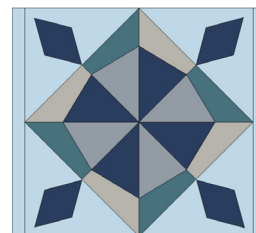
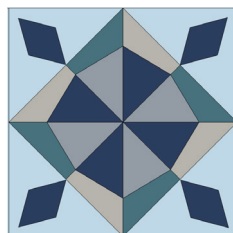
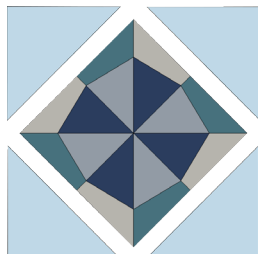

SET PRINTER TO "ACTUAL SIZE" WHEN PRINTING THIS PAGE.

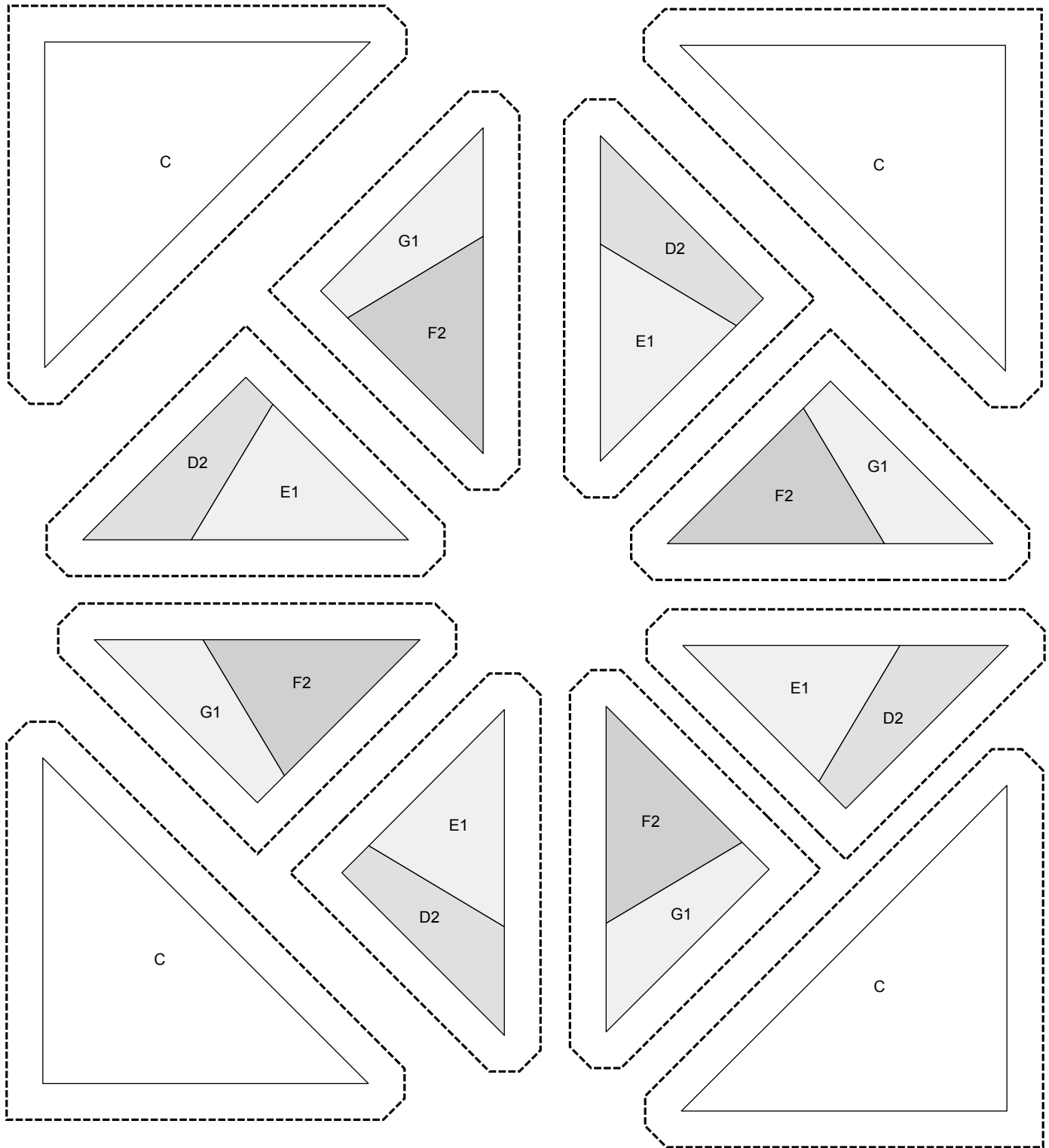

2"

SET PRINTER TO "ACTUAL SIZE" WHEN PRINTING THIS PAGE.

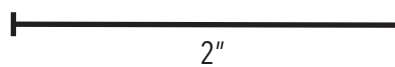
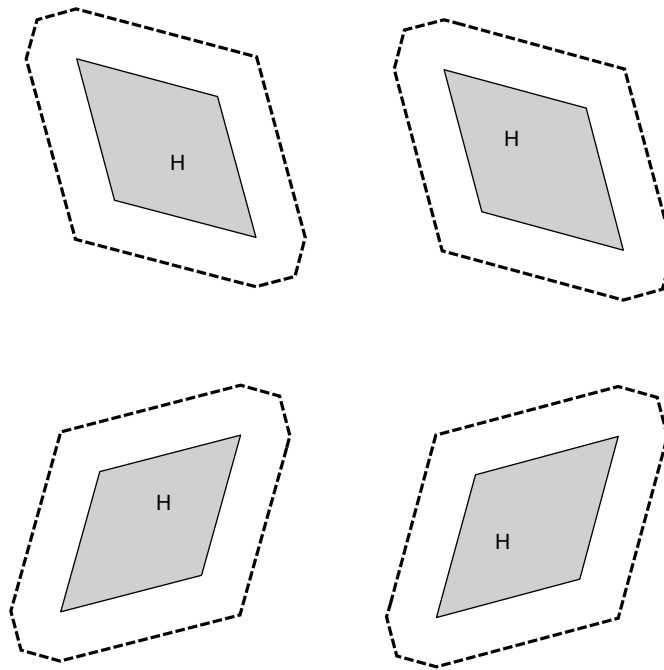

SET PRINTER TO "ACTUAL SIZE" WHEN PRINTING THIS PAGE.

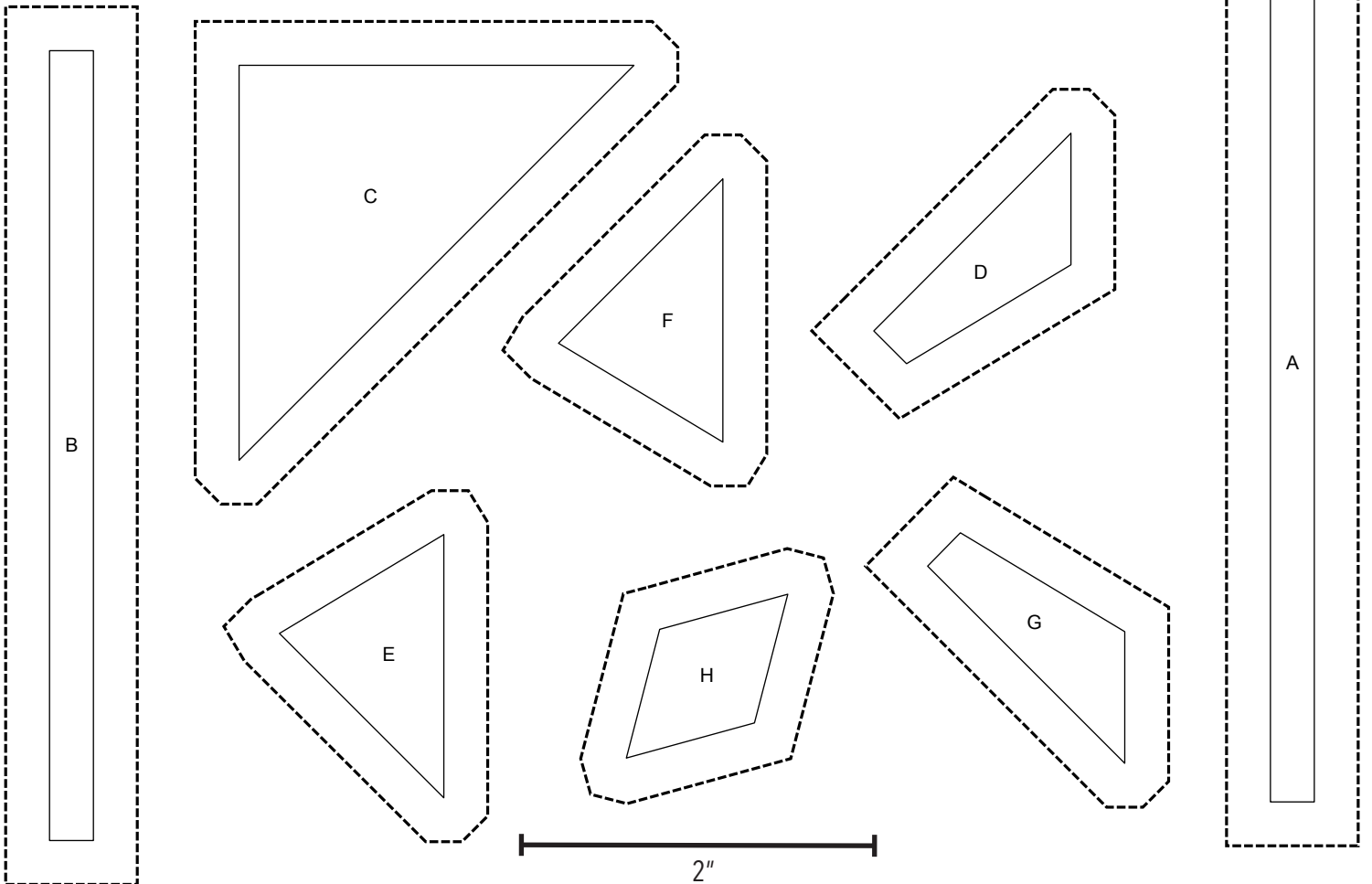
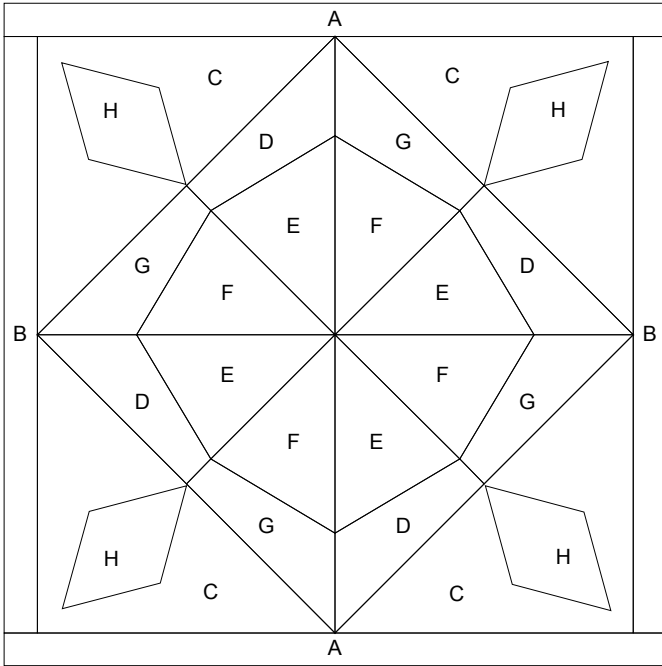

The Jane Stickle Quilt - Block F2

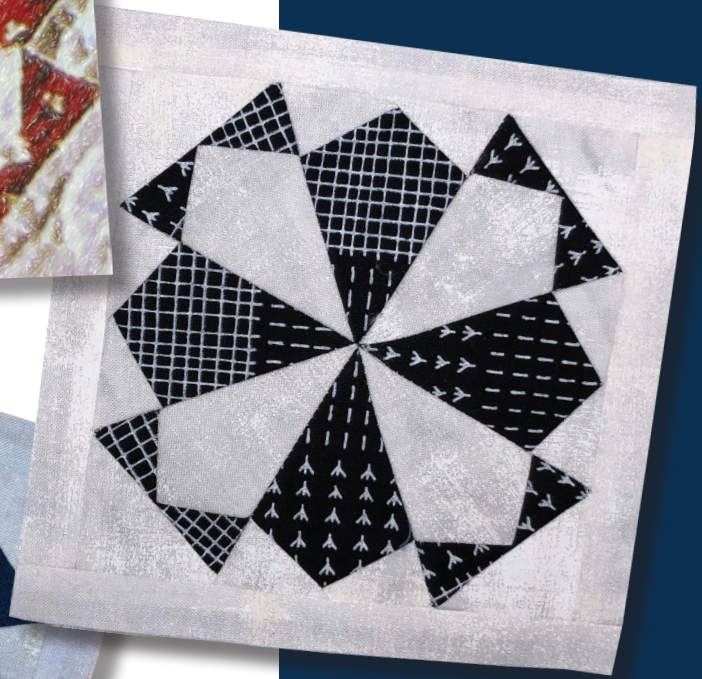
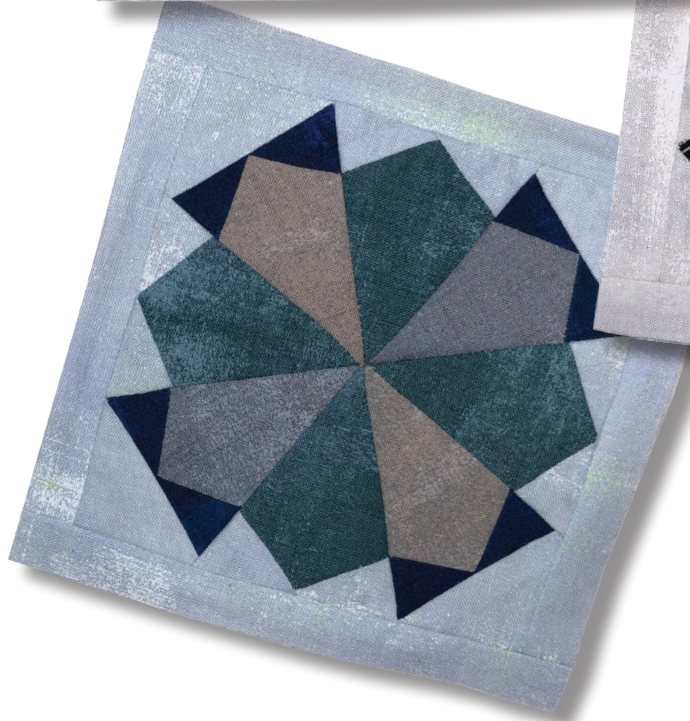

What you need:

Patches	Quantity/size
A*	(2) 1" x 6"
B*	(2) 1" x 5"
C	(2) 2½" x 2½", cut once diagonally
D	(2) 2" x 2½", cut once diagonally
E	(2) 2" x 2½", cut once diagonally
F	(4) 2" x 2½", cut once diagonally
G	(2) 2½" x 3" - beige (2) 2½" x 3" - gray
H	(4) 2½" x 3"

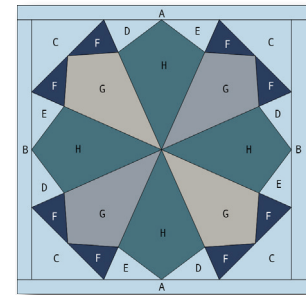

Hobbystash Colorway

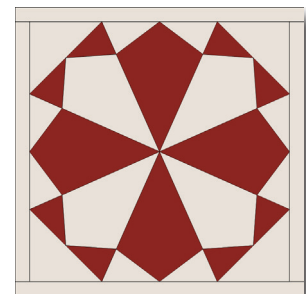

Jane Stickle Colorway

**The actual required width for Unit A and Unit B units is ¾". The increased width specified above allows for squaring the block to exactly 5½".*

Assembly:

- Using the templates provided on Page F2-2, foundation piece the sections of the block.
- Assemble the sections and sew together.
- Join Unit B to the right side of the block, and then the left.
- Join Unit A to the top of the block and then the bottom. Square up block to measure 5½" x 5½" square.

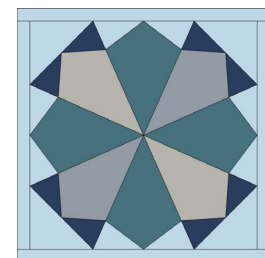
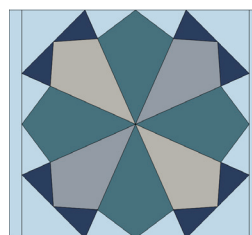
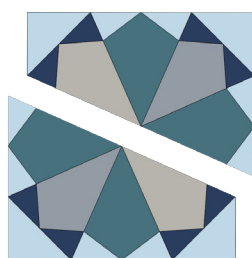
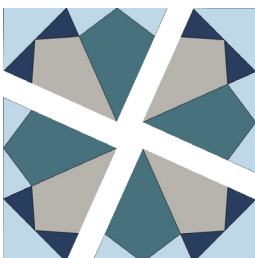

SET PRINTER TO "ACTUAL SIZE" WHEN PRINTING THIS PAGE.

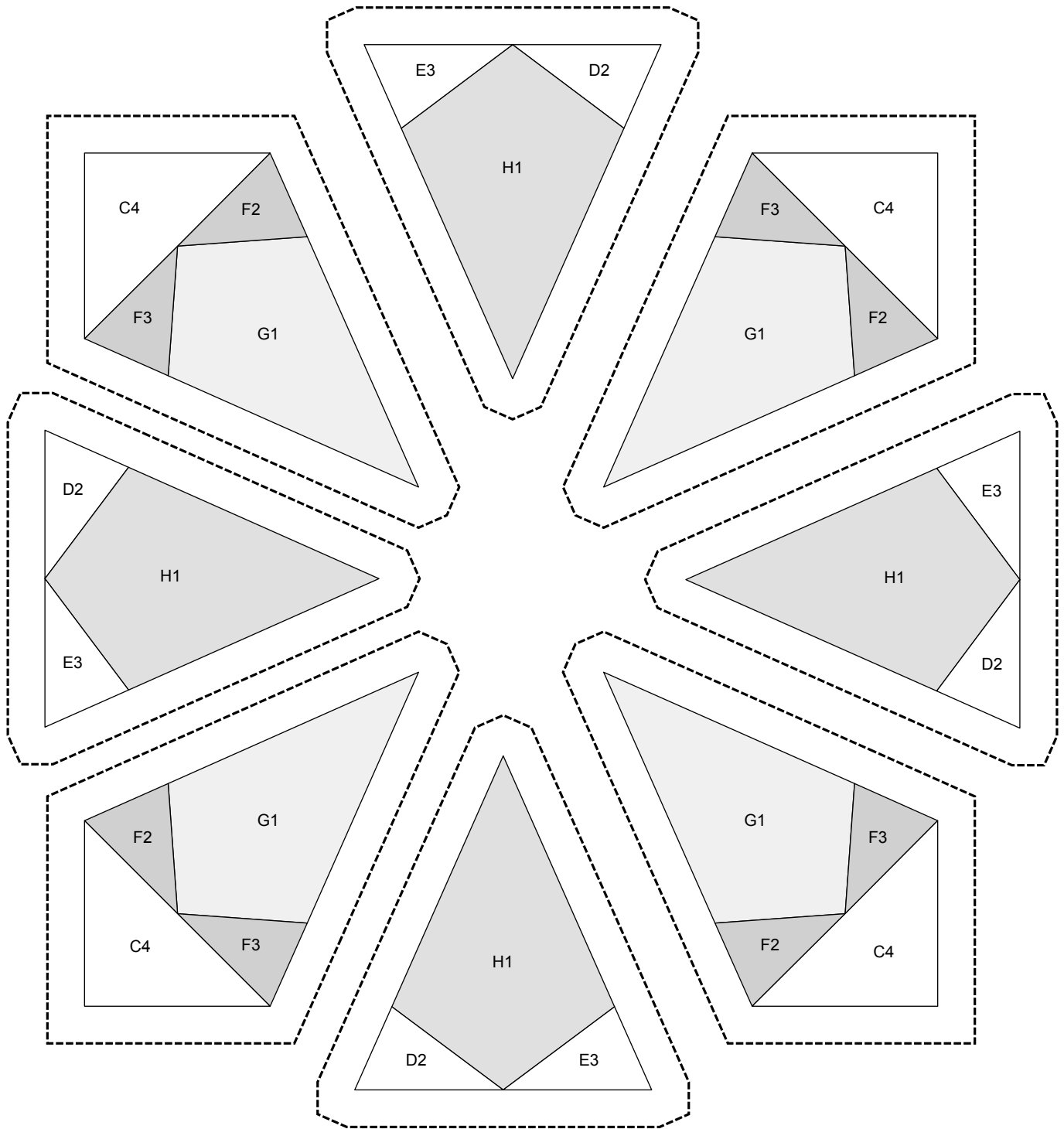

SET PRINTER TO "ACTUAL SIZE" WHEN PRINTING THIS PAGE.

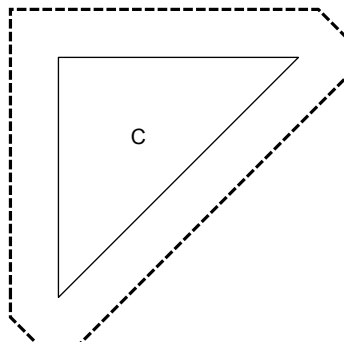
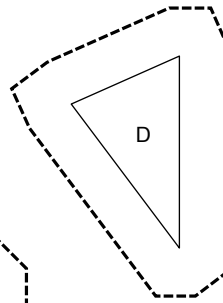
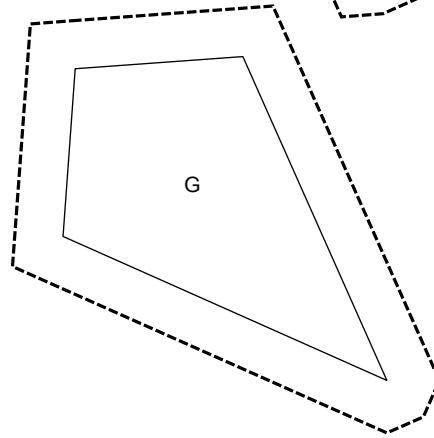
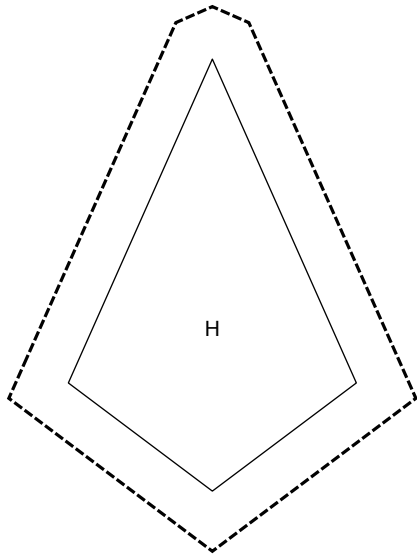
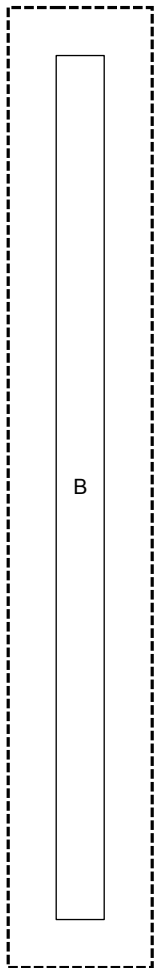
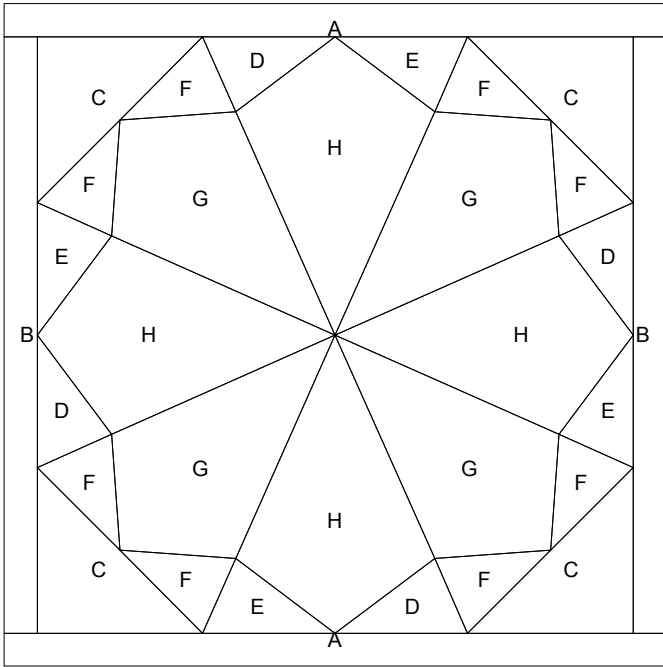

2"

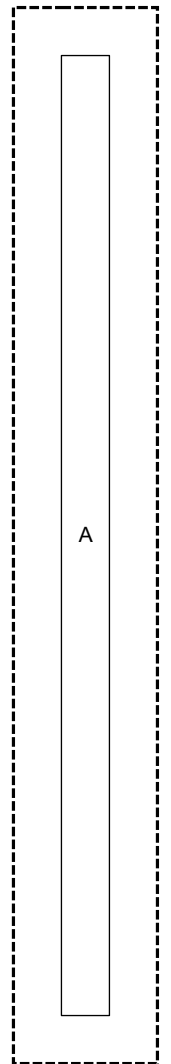

The Jane Stickle Quilt - Block F3

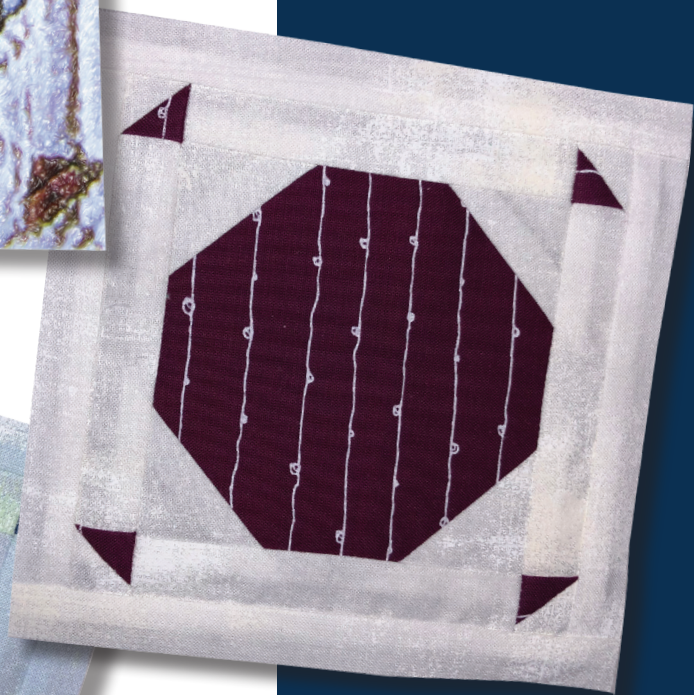
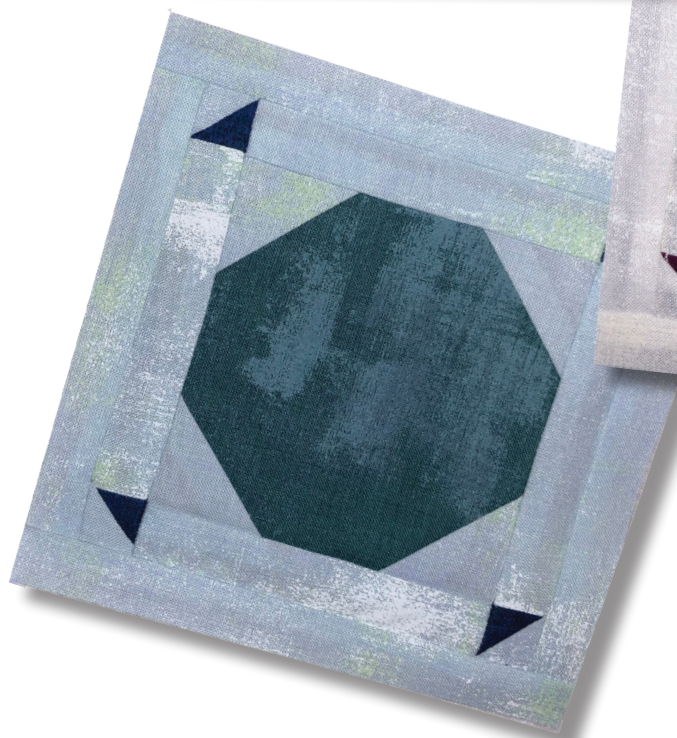
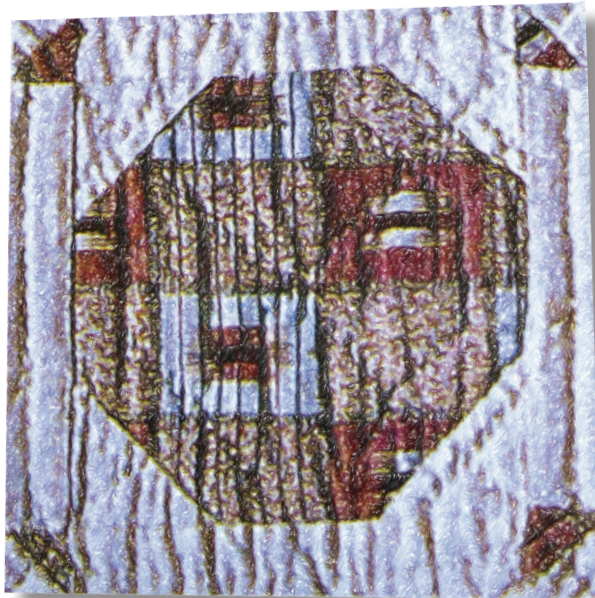

What you need:

Patches	Quantity/size
A*	(2) 1" x 6"
B*	(2) 1" x 5"
C	(2) 2" x 2" - light blue, cut once diagonally (2) 2" x 2" - navy, cut once diagonally
D	(4) 1½" x 4½"
E	(2) 2½" x 2½", cut once diagonally
F	(1) 5" x 5"

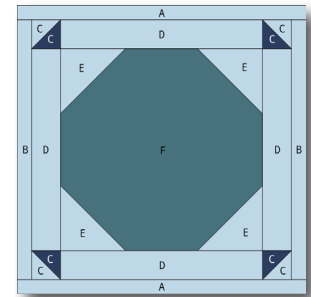

Hobbystash Colorway

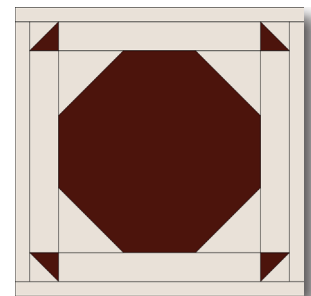

Jane Stickle Colorway

**The actual required width for Unit A and Unit B units is ¾". The increased width specified above allows for squaring the block to exactly 5½".*

Assembly:

1. Using the templates provided on Page F3-2, foundation piece the sections of the block.
2. Assemble the sections and sew together.
3. Join Unit B to the right side of the block, and then the left.
4. Join Unit A to the top of the block and then the bottom. Square up block to measure 5½" x 5½" square.

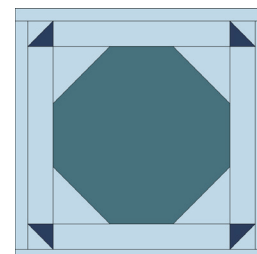
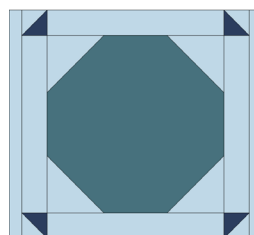
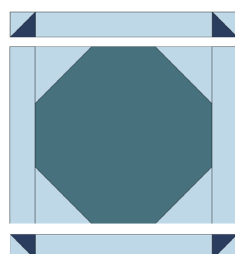

SET PRINTER TO "ACTUAL SIZE" WHEN PRINTING THIS PAGE.

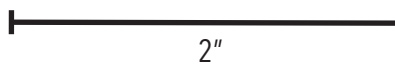
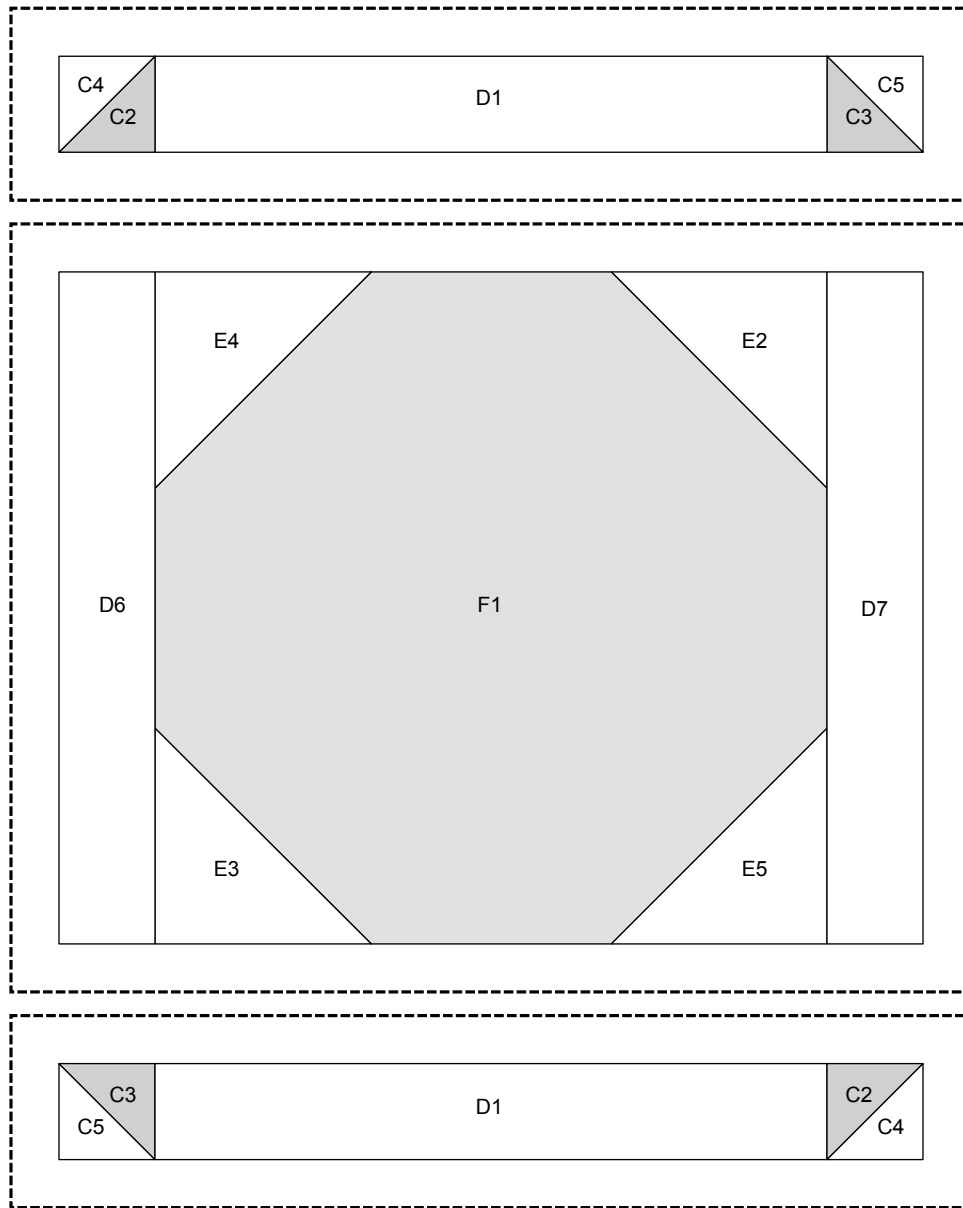

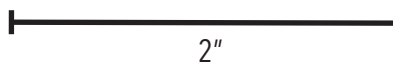
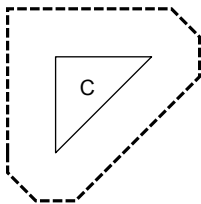
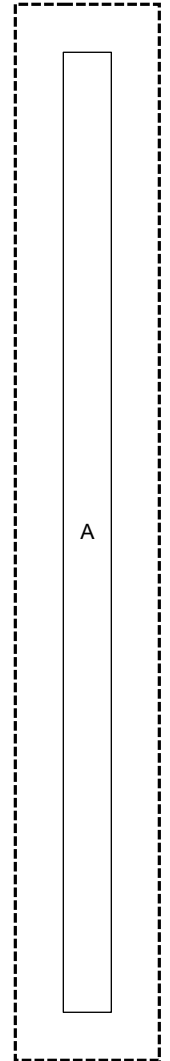
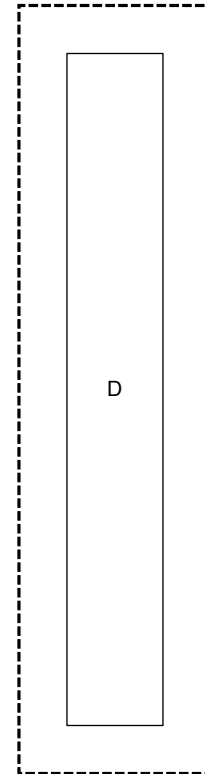
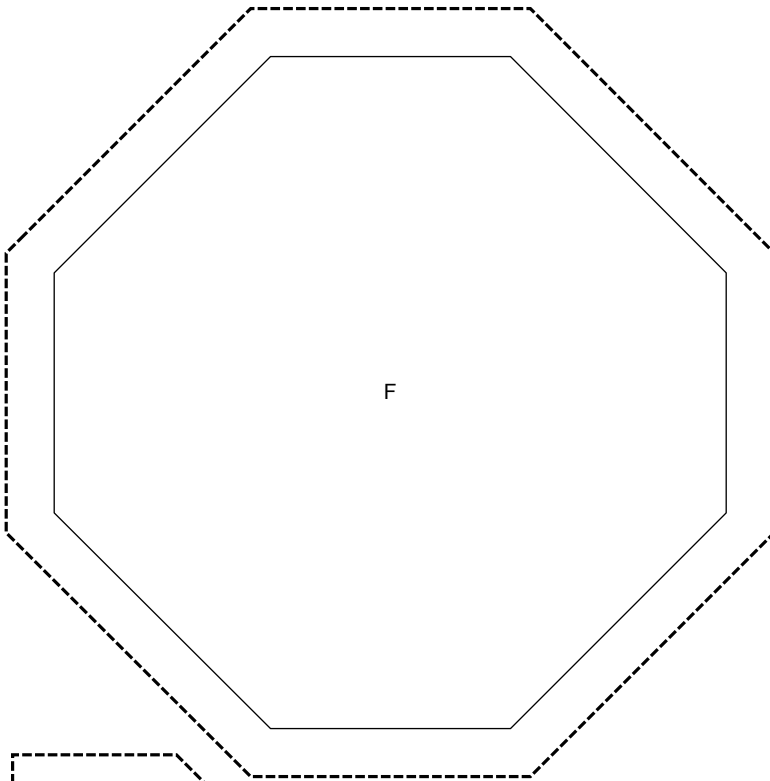
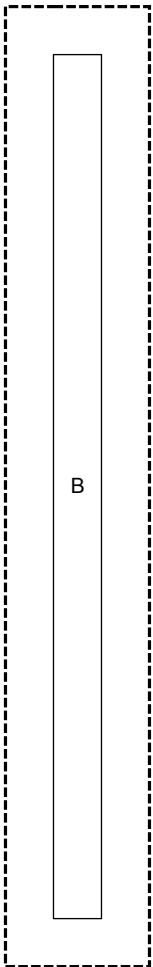
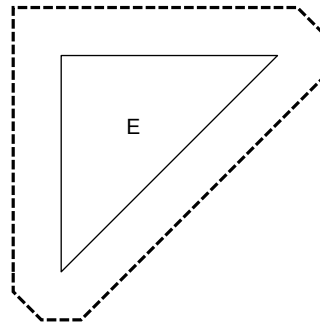
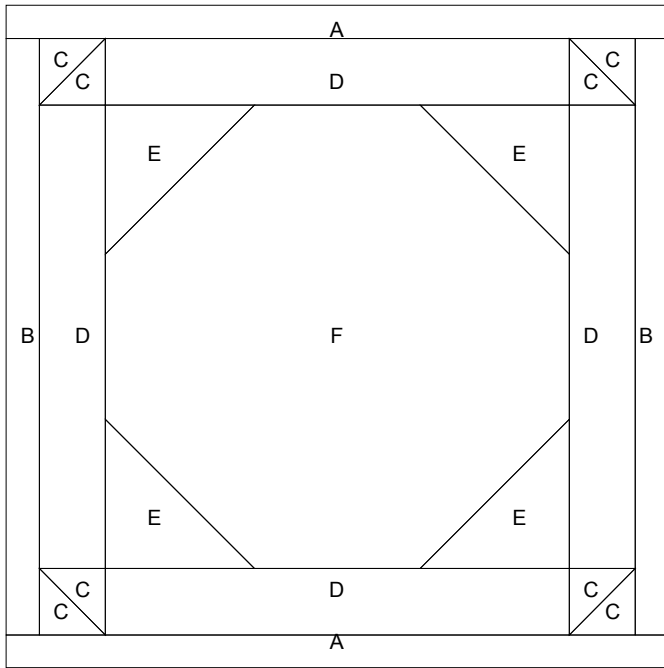

SET PRINTER TO "ACTUAL SIZE" WHEN PRINTING THIS PAGE.



The Jane Stickle Quilt - Block F4



What you need:

Patches	Quantity/size
A*	(2) 1" x 6"
B*	(2) 1" x 5"
C 	(2) 2" x 2" - navy, cut once diagonally
D 	(1) 4½" x 4½" - navy, cut twice diagonally
E	(2) 2" x 3" - beige (2) 2" x 3" - gray
F	(1) 2" x 2" - green

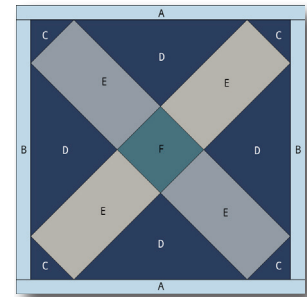

Hobbystash Colorway

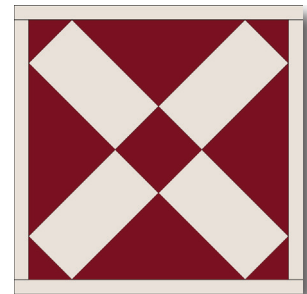

Jane Stickle Colorway

**The actual required width for Unit A and Unit B units is ¾". The increased width specified above allows for squaring the block to exactly 5½".*

Assembly:

1. Using the templates provided on Page F4-2, foundation piece the sections of the block.
2. Assemble the sections and sew together.
3. Join Unit B to the right side of the block, and then the left.
4. Join Unit A to the top of the block and then the bottom. Square up block to measure 5½" x 5½" square.

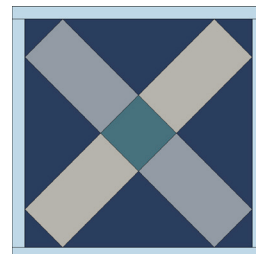
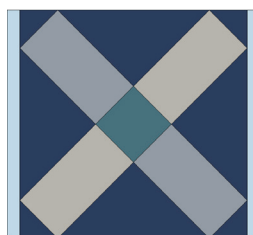

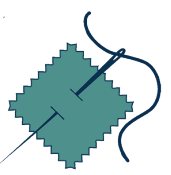

SET PRINTER TO "ACTUAL SIZE" WHEN PRINTING THIS PAGE.

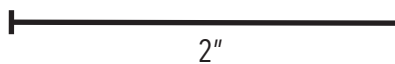
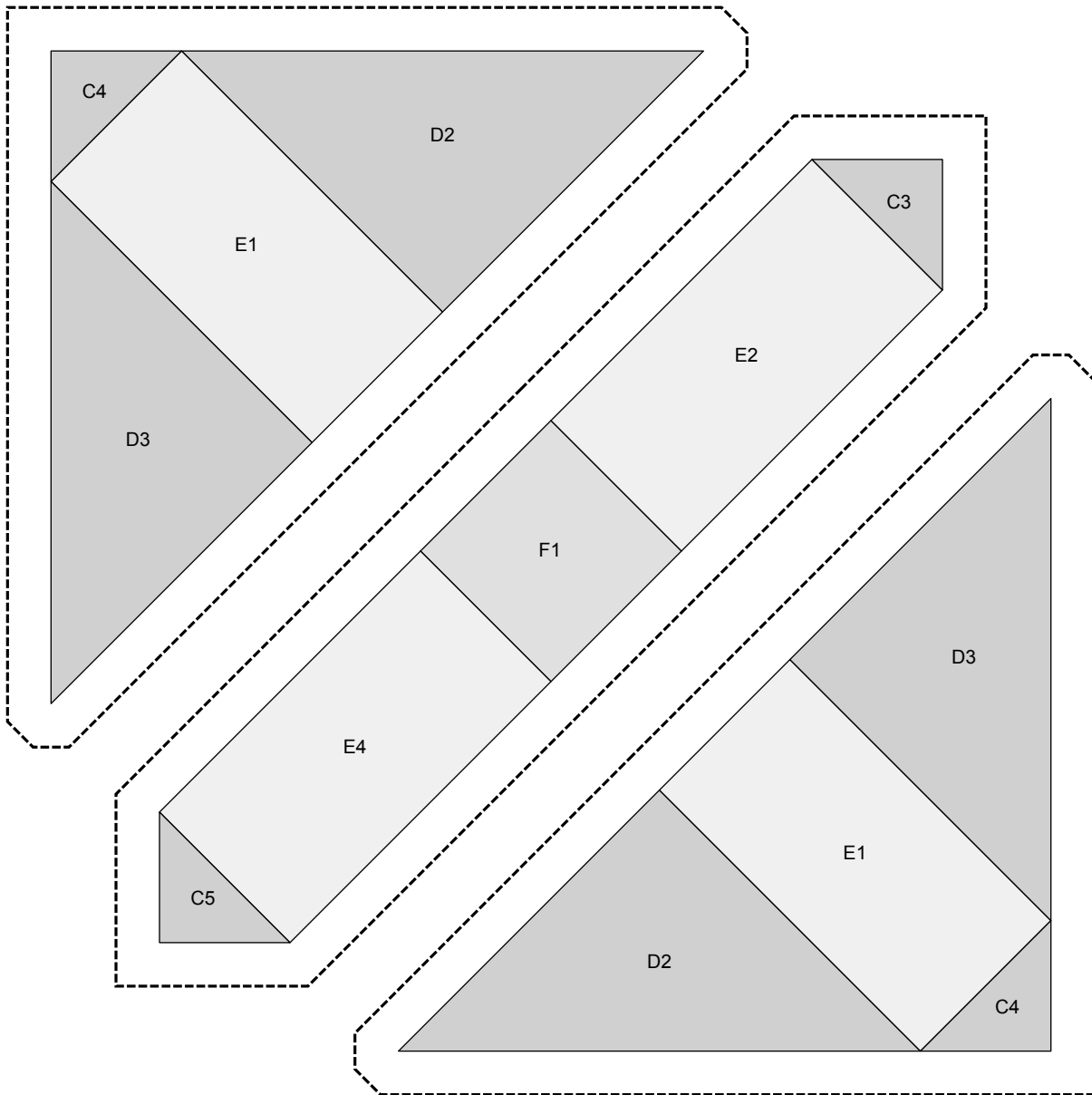

SET PRINTER TO "ACTUAL SIZE" WHEN PRINTING THIS PAGE.

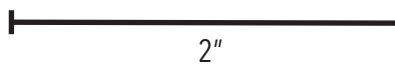
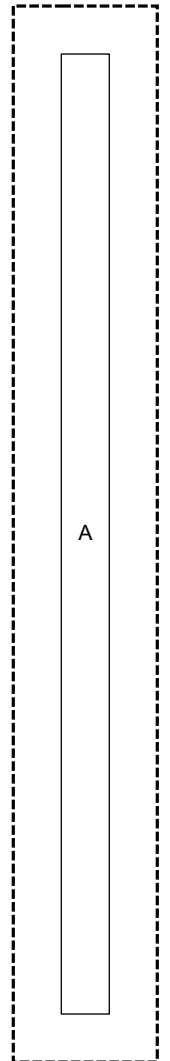
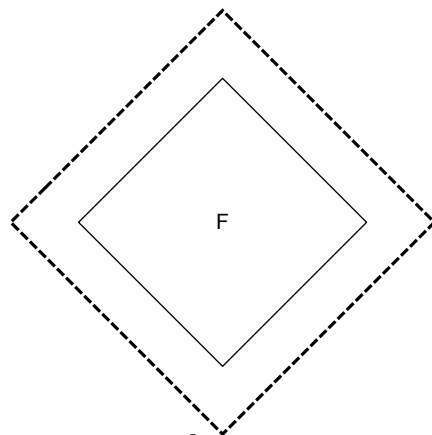
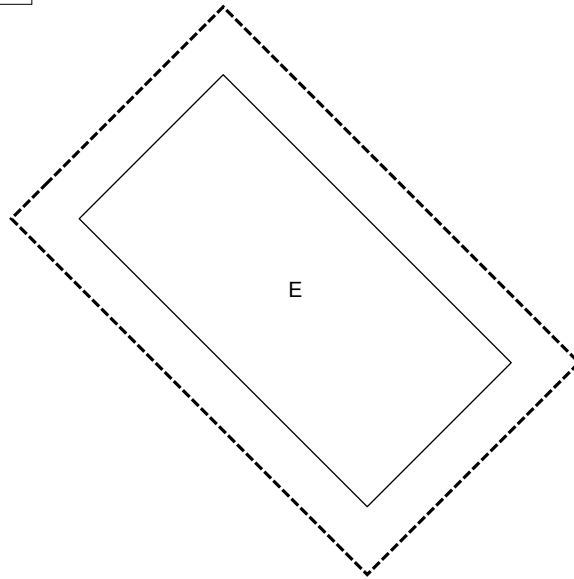
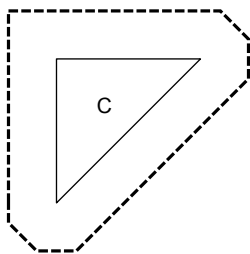
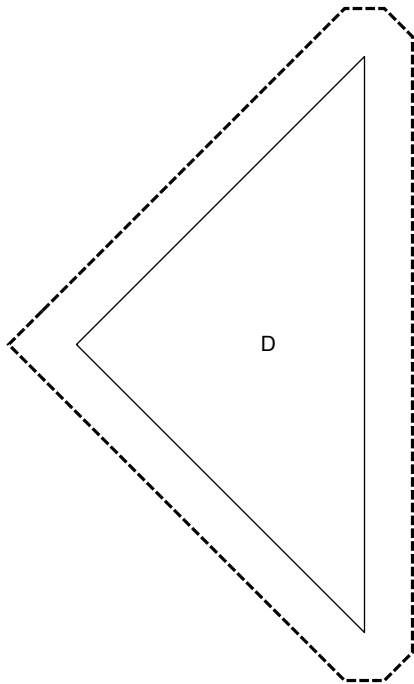
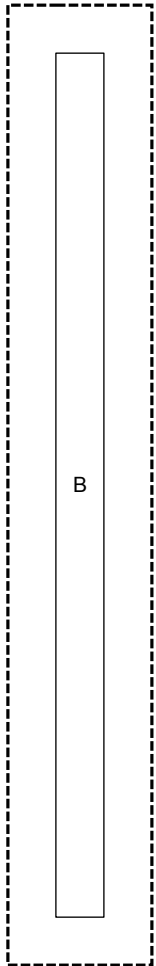
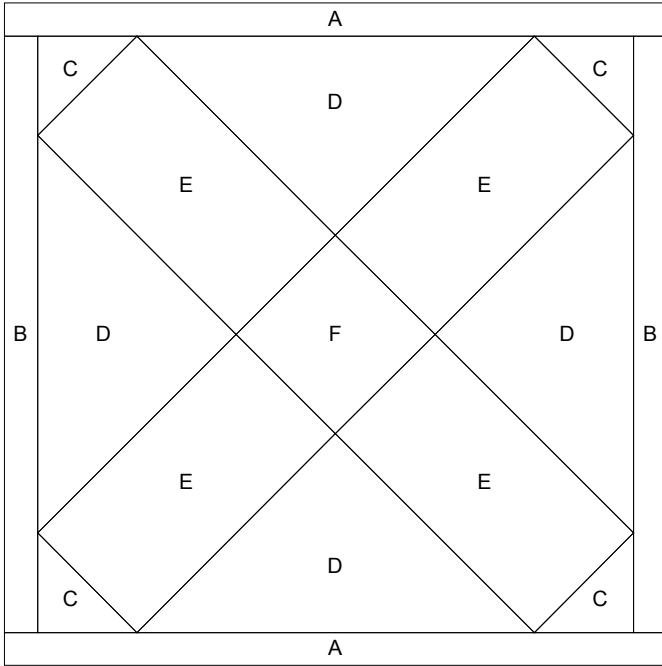

The Jane Stickle Quilt - Block F5

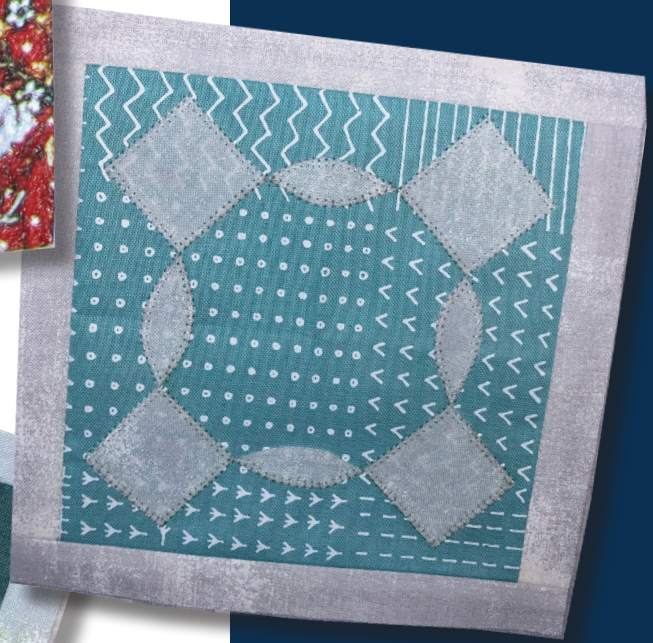
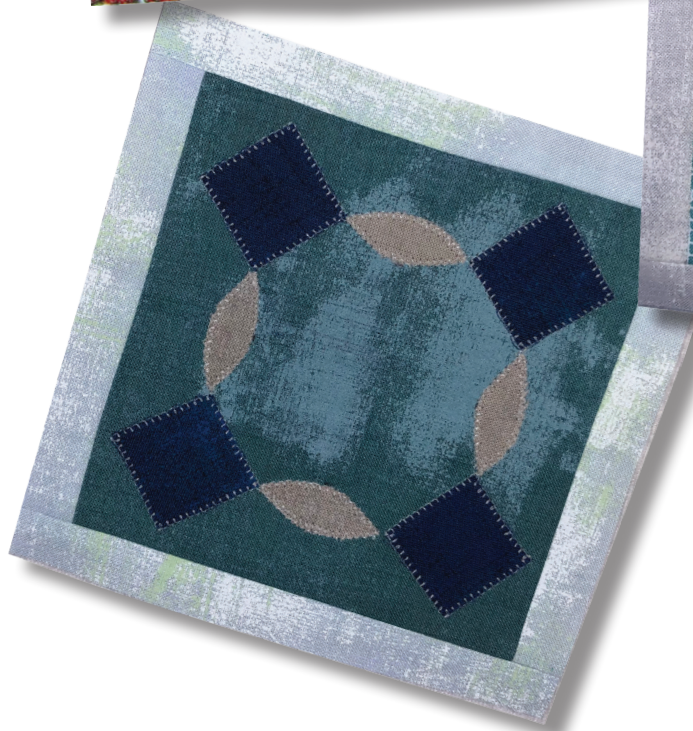

What you need:

Patches	Quantity/size
A*	(2) 1" x 6"
B*	(2) 1" x 5"
C	(1) 6" x 6"
D	(4) 1½" x 1½"
E	(4) 1" x 1½"

**The actual required width for Unit A and Unit B units is ¾". The increased width specified above allows for squaring the block to exactly 5½".*

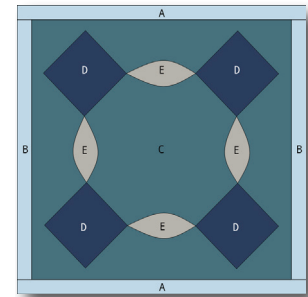

Hobbystash Colorway

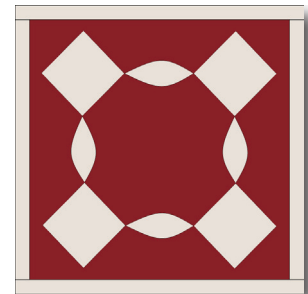

Jane Stickle Colorway

Assembly:

1. Using the templates provided on Page F5-2, appliqué the four squares and four melons to Unit C.
2. Join Unit B to the right side of the block, and then the left.
3. Join Unit A to the top of the block and then the bottom. Square up block to measure 5½" x 5½" square.

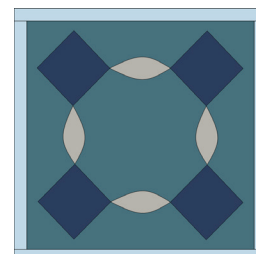
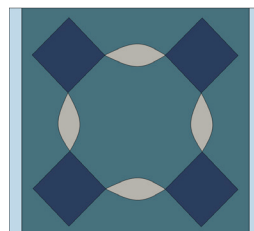
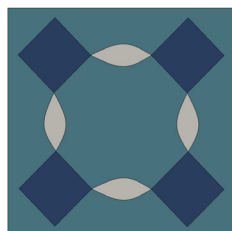

SET PRINTER TO "ACTUAL SIZE" WHEN PRINTING THIS PAGE.

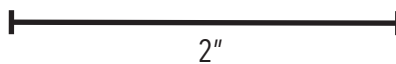
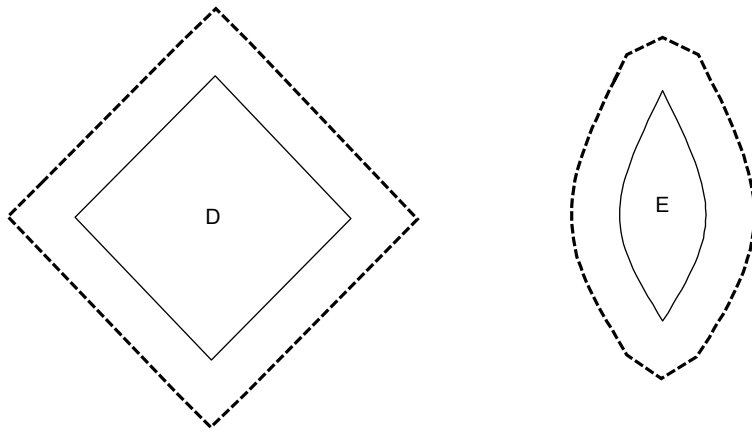

SET PRINTER TO "ACTUAL SIZE" WHEN PRINTING THIS PAGE.

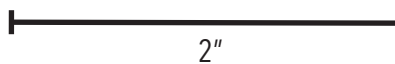
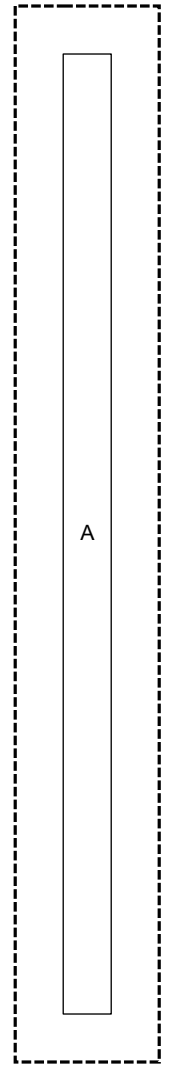
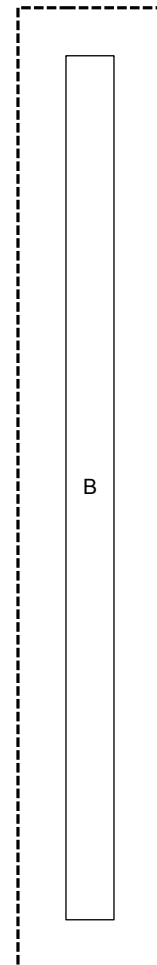
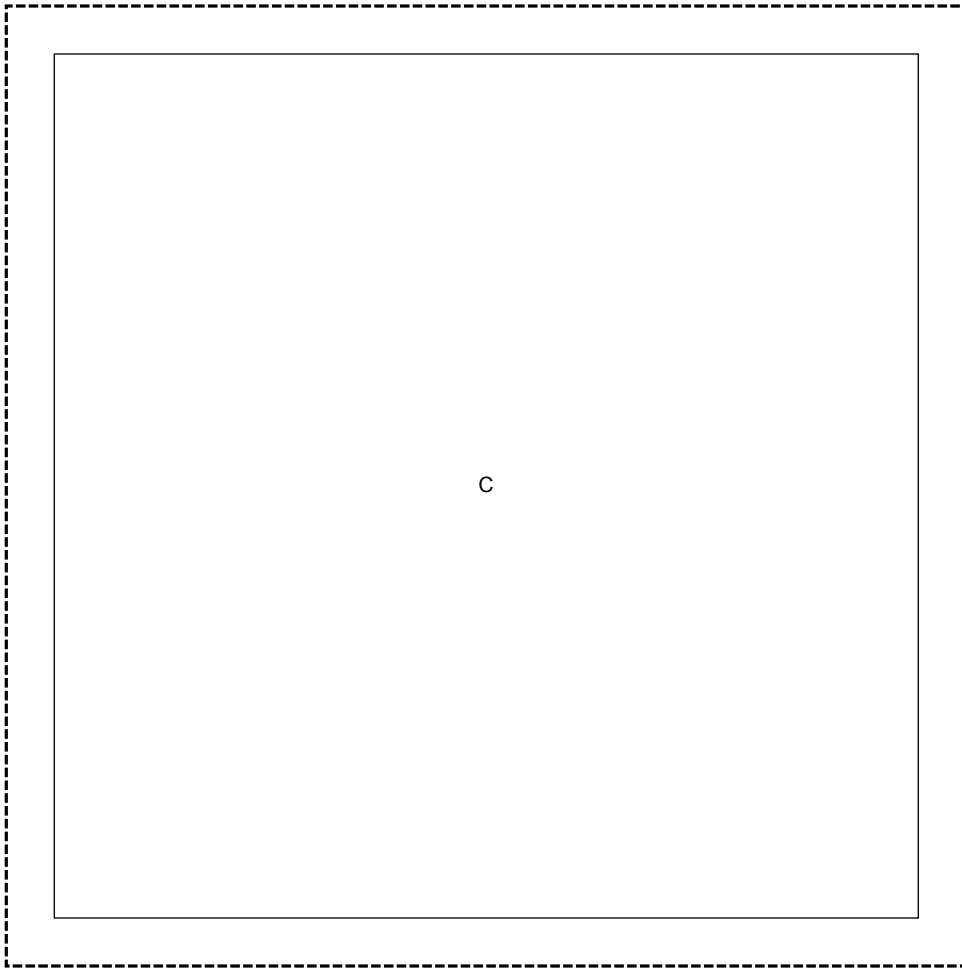
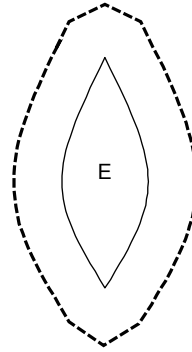
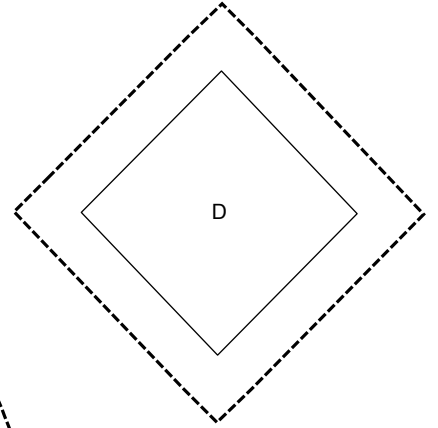
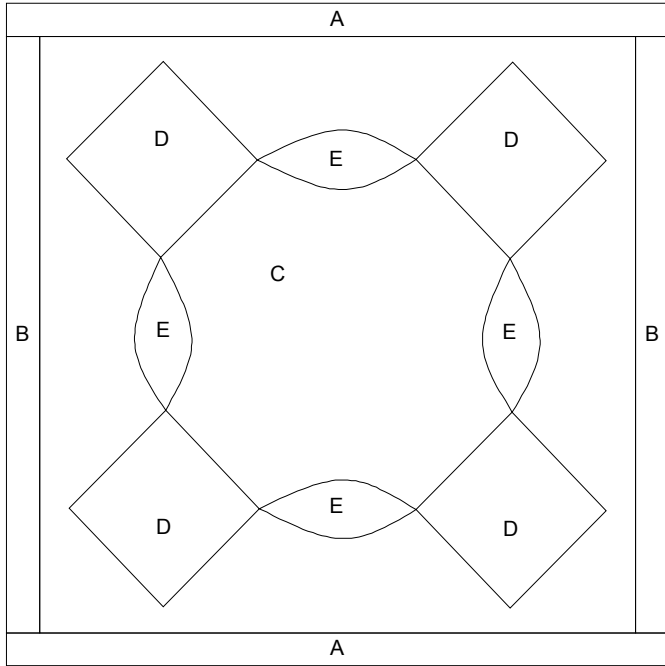

The Jane Stickle Quilt - Block F6

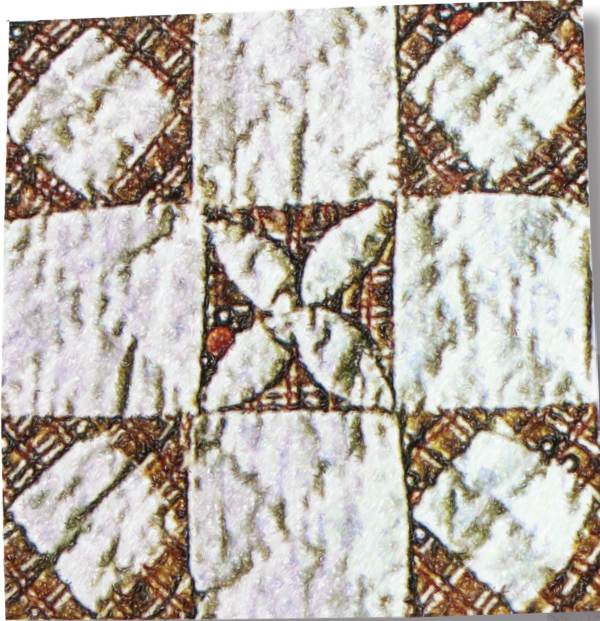

What you need:

Patches	Quantity/size
A*	(2) 1" x 6"
B*	(2) 1" x 5"
C 	(8) 2" x 2", cut once diagonally
D	(4) 2" x 2" - light blue (1) 2" x 2" - green
E	(2) 2" x 2" - beige (2) 2" x 2" - gray
F	(2) 1" x 2" - gray (2) 1" x 2" - beige

**The actual required width for Unit A and Unit B units is ¾". The increased width specified above allows for squaring the block to exactly 5½".*

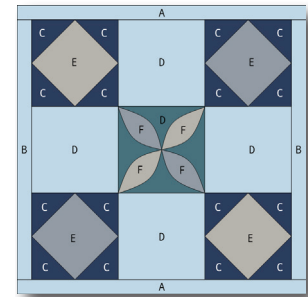

Hobbystash Colorway

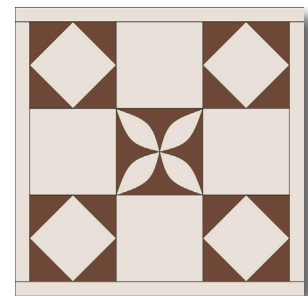

Jane Stickle Colorway

Assembly:

- Using the templates provided on Page F6-2, foundation piece the four outer corners of the block.
- Assemble the Step 1 sections with the five Unit D and sew together.
- Using the template provided on Page F6-2, appliqué four Unit F melons to the center square of the block.
- Join Unit B to the right side of the block, and then the left.
- Join Unit A to the top of the block and then the bottom. Square up block to measure 5½" x 5½" square.

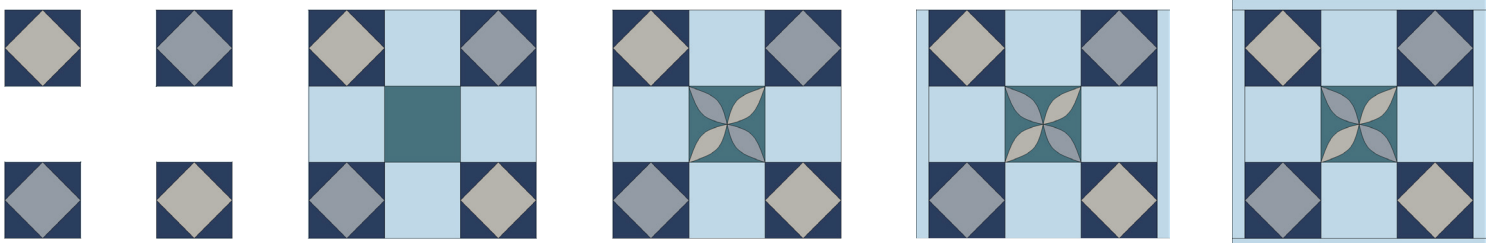

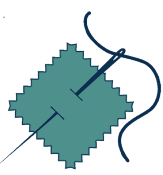

SET PRINTER TO "ACTUAL SIZE" WHEN PRINTING THIS PAGE.

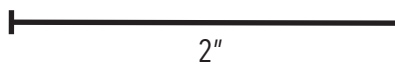
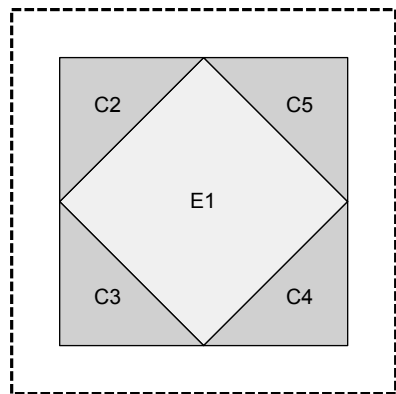
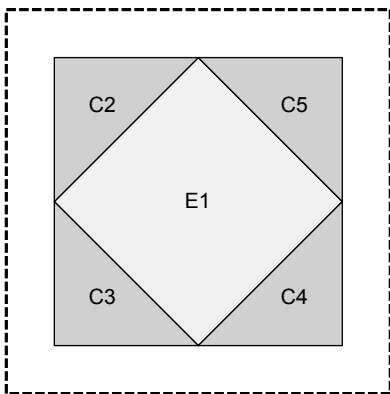
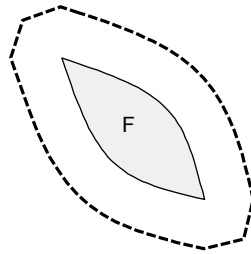
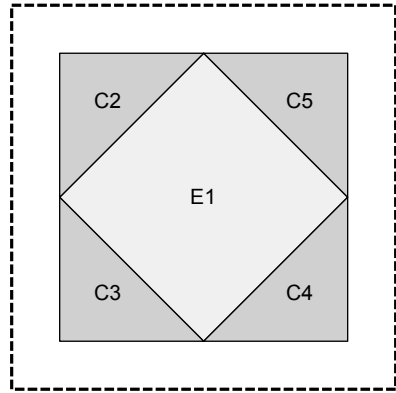
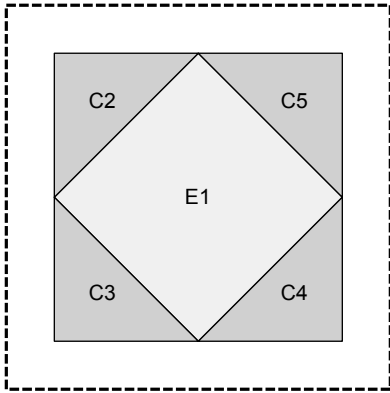

SET PRINTER TO "ACTUAL SIZE" WHEN PRINTING THIS PAGE.

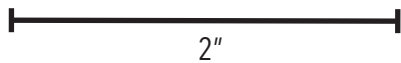
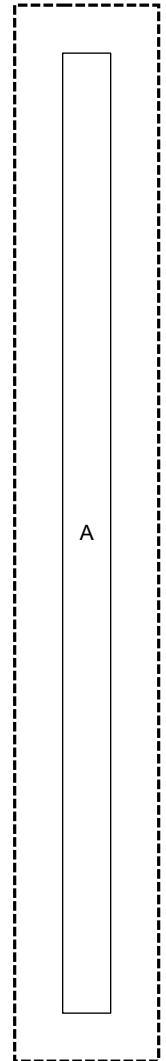
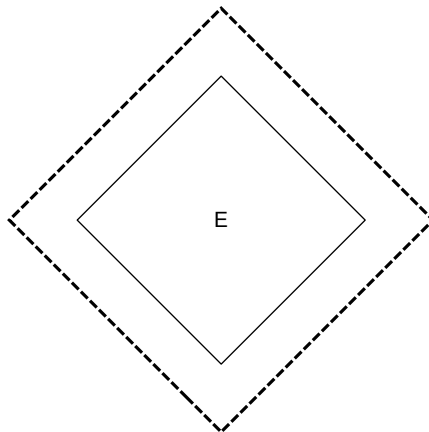
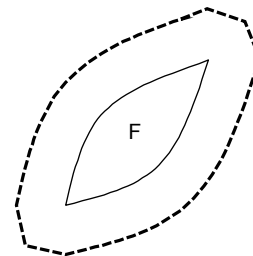
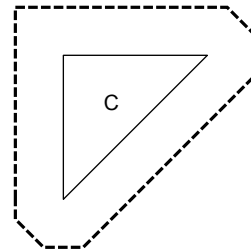
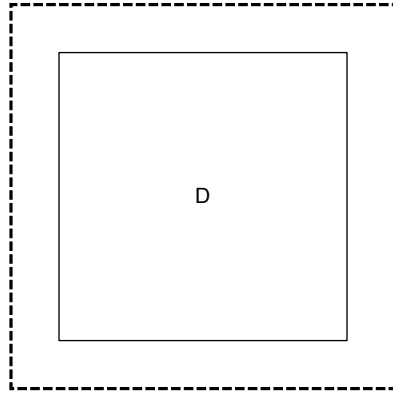
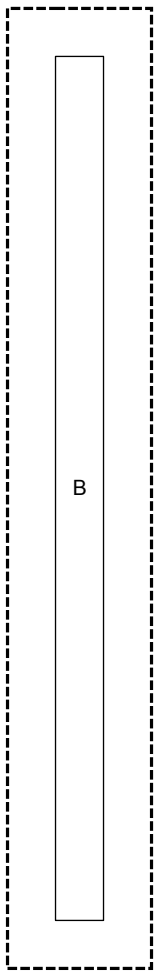
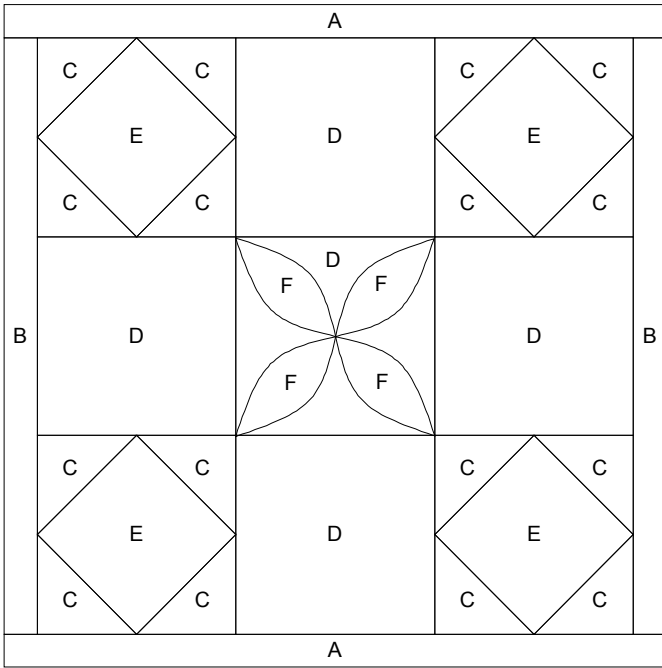

The Jane Stickle Quilt - Block F7



What you need:

Patches	Quantity/size
A*	(2) 1" x 6"
B*	(2) 1" x 5"
C	(4) 1" x 5"
D	(4) 1" x 4⅛"
E	(4) 1⅜" x 1⅜"
F	(1) 3" x 3"
G	(4) 1¾" x 1¾"
H	(1) 2¼" x 2¼"

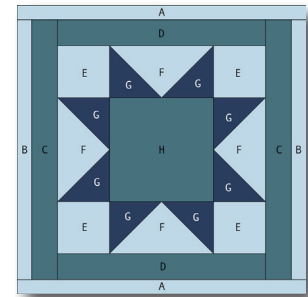

Hobbystash Colorway

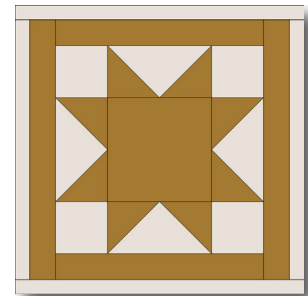

Jane Stickle Colorway

**The actual required width for Unit A and Unit B units is ¾". The increased width specified above allows for squaring the block to exactly 5½".*

Assembly:

1. Following [BASIC INSTRUCTIONS](#) for *Flying Geese using "no waste" method*, use the Unit F and four Unit G to make four flying geese units.
2. Arrange one Step 1 flying geese unit between 2 Unit E as shown and sew together. Repeat for a total of two.
3. Arrange two Step 1 flying geese units on each side of Unit H as shown and sew together. Arrange completed row between the two rows created in Step 2 as shown and sew together.
4. Join Unit D to the top of the block and then the bottom.
5. Join Unit C to the right side of the block, and then the left.
6. Join Unit B to the right side of the block, and then the left.
7. Join Unit A to the top of the block and then the bottom. Square up block to measure 5½" x 5½" square.

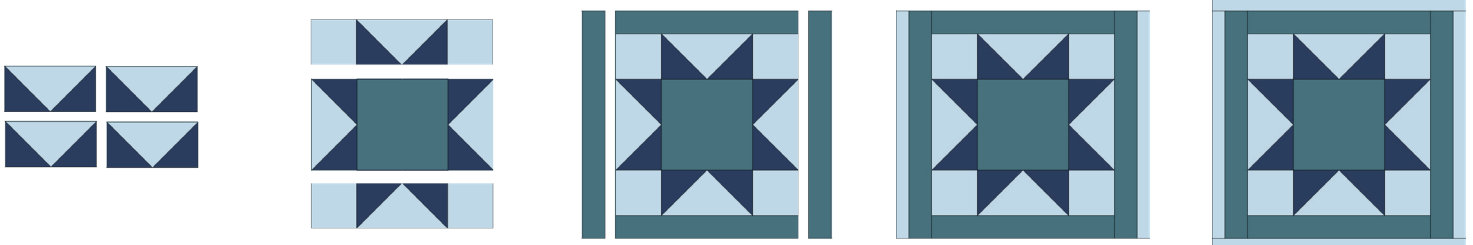

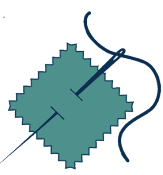

SET PRINTER TO "ACTUAL SIZE" WHEN PRINTING THIS PAGE.

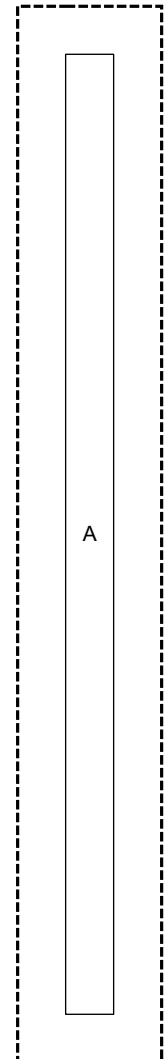
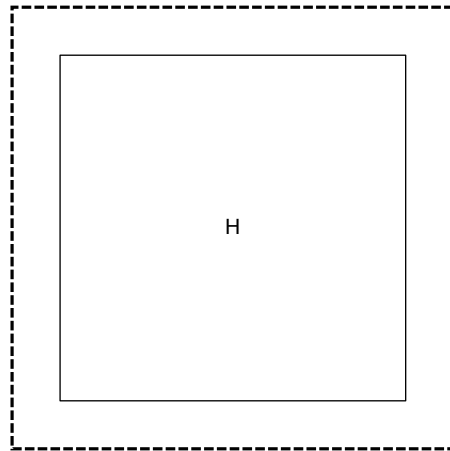
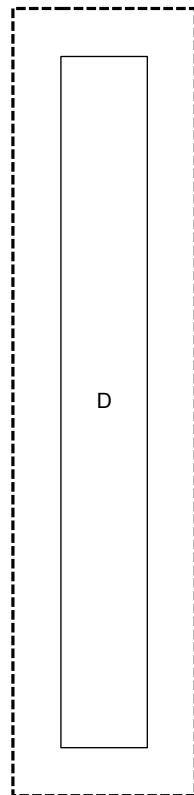
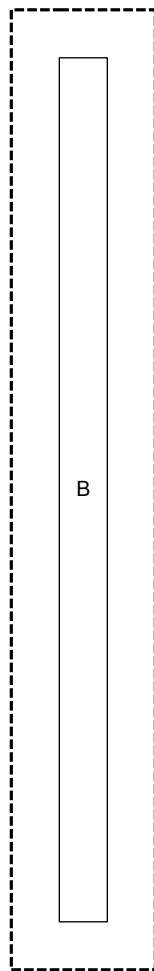
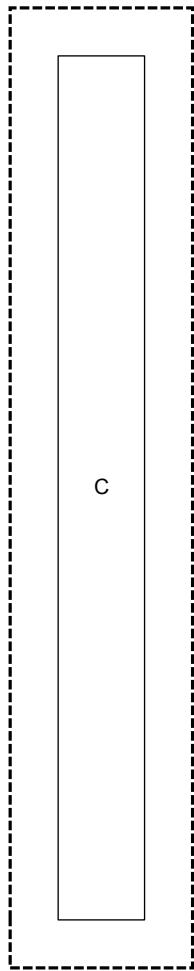
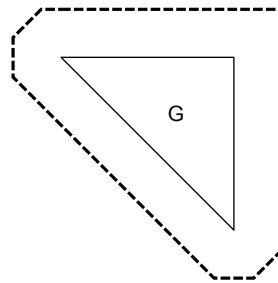
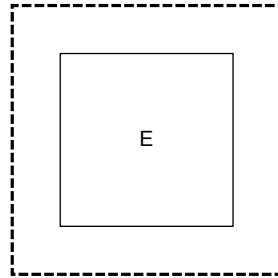
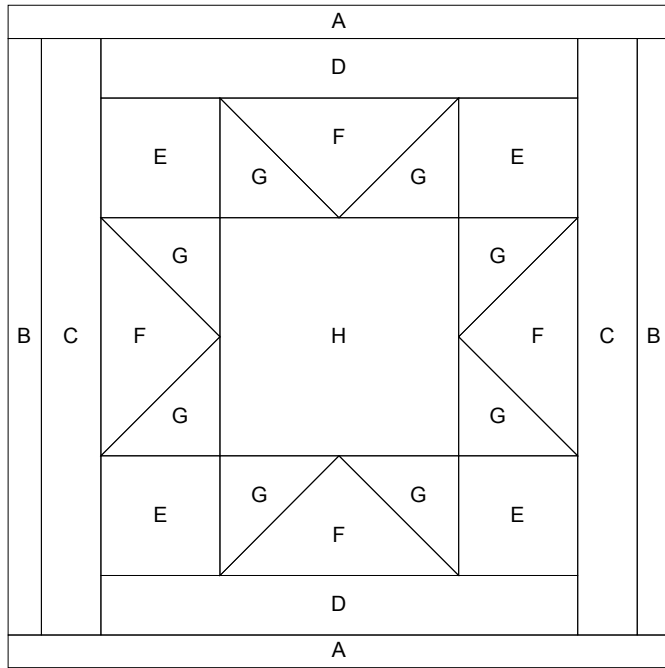



2"

The Jane Stickle Quilt - Block F8



What you need:

Patches	Quantity/size
A*	(2) 1" x 6"
B*	(2) 1" x 5"
C	(4) 1½" x 3½"
D	(2) 1½" x 2½"
E	(4) 1½" x 3"
F	(2) 1½" x 2½"
G	(4) 2" x 2"
H	 (4) 2½" x 2½", cut once diagonally
I	(4) 1½" x 1½"
J	(4) 1½" x 2"
K	(1) 2" x 2"
L	 (1) 3½" x 3½", cut twice diagonally

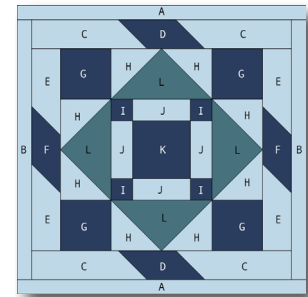

Hobbystash Colorway

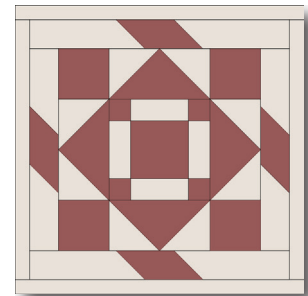

Jane Stickle Colorway

**The actual required width for Unit A and Unit B units is ¾". The increased width specified above allows for squaring the block to exactly 5½".*

Assembly:

- Using the templates provided on Page F8-2, foundation piece the sections of the block.
- Assemble the sections and sew together.
- Join Unit B to the right side of the block, and then the left.
- Join Unit A to the top of the block and then the bottom. Square up block to measure 5½" x 5½" square.

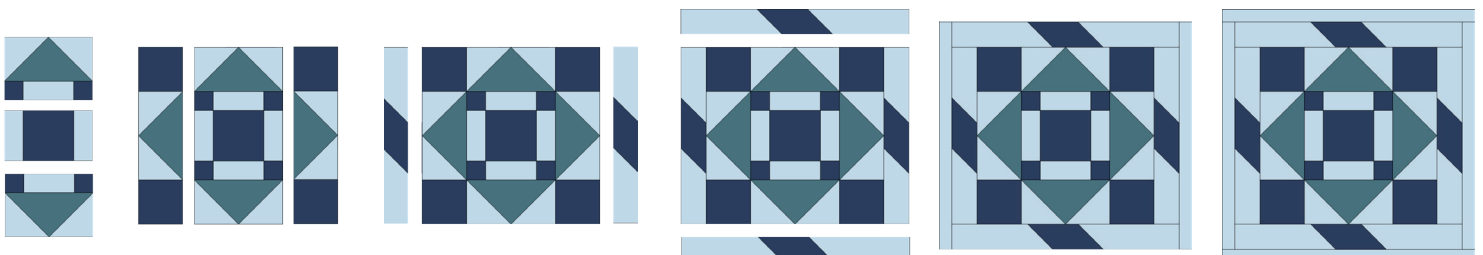

SET PRINTER TO "ACTUAL SIZE" WHEN PRINTING THIS PAGE.

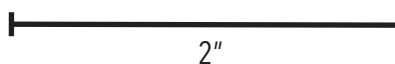
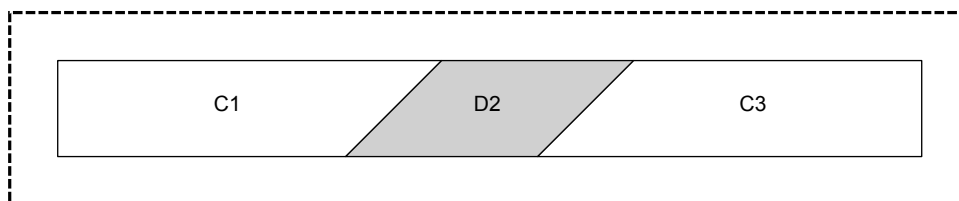
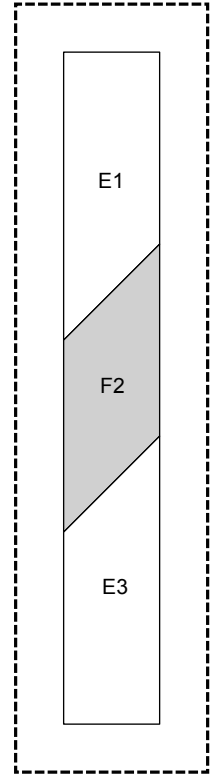
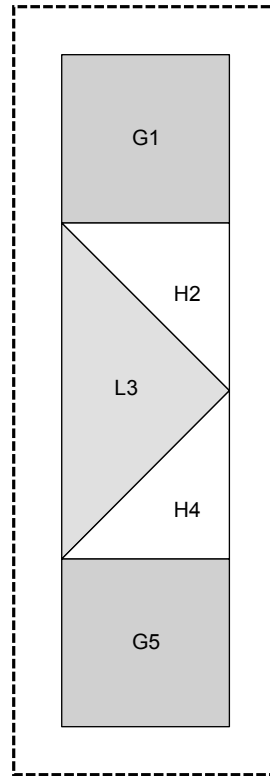
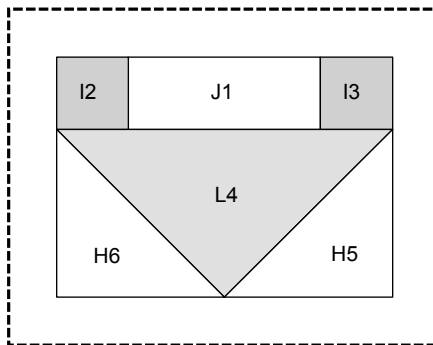
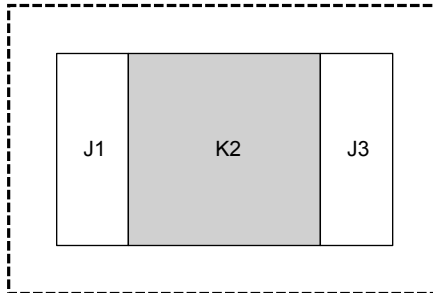
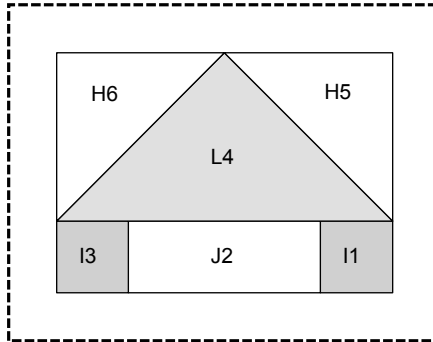
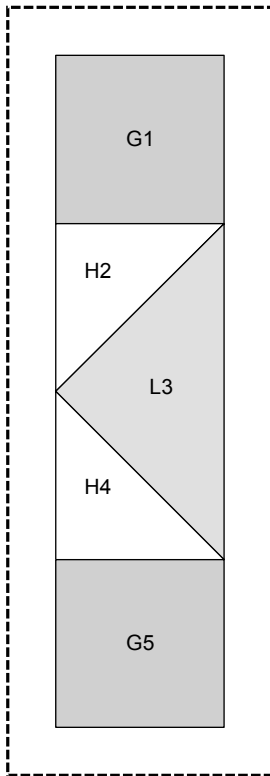
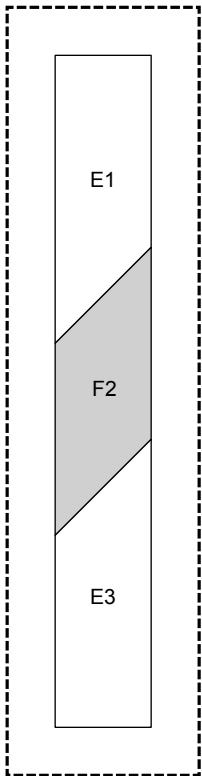
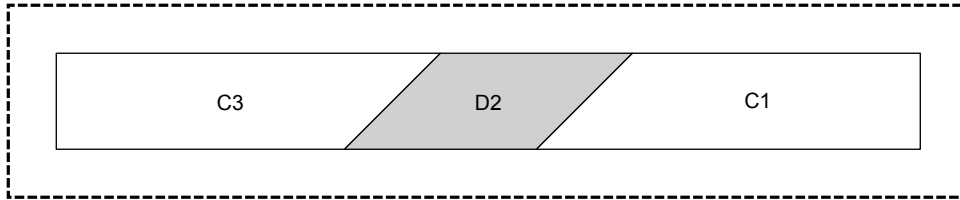

SET PRINTER TO "ACTUAL SIZE" WHEN PRINTING THIS PAGE.

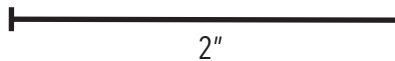
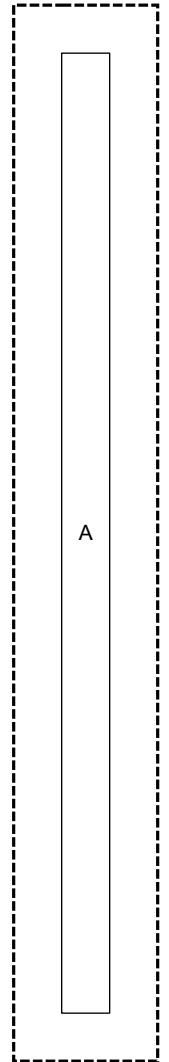
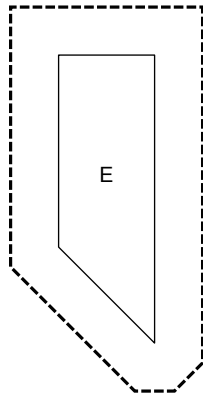
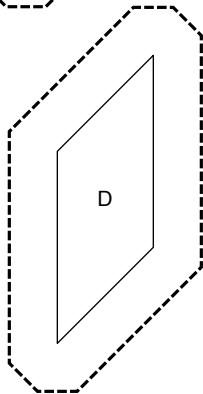
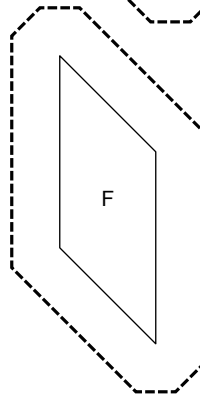
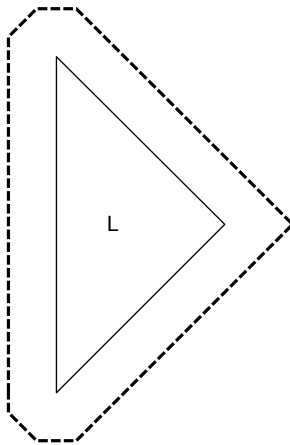
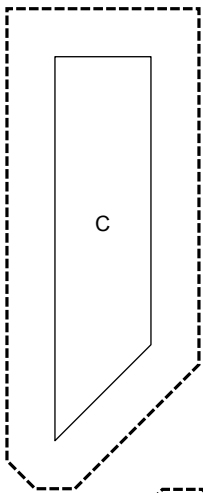
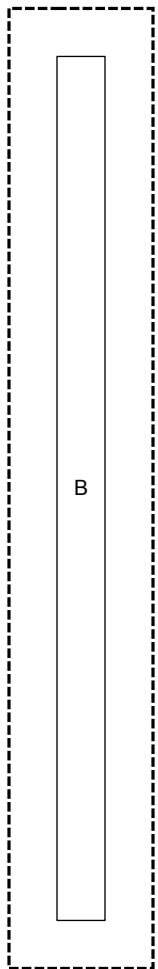
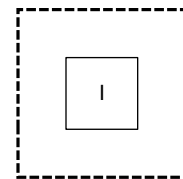
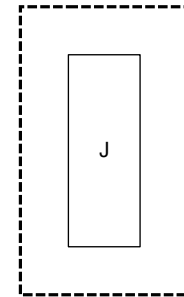
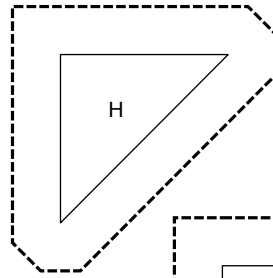
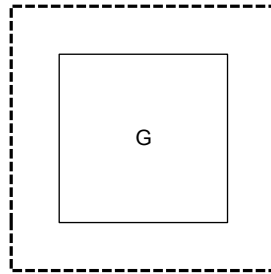
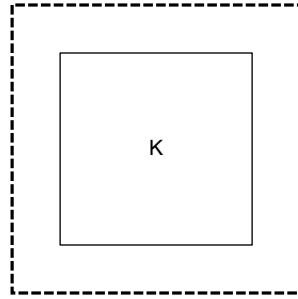
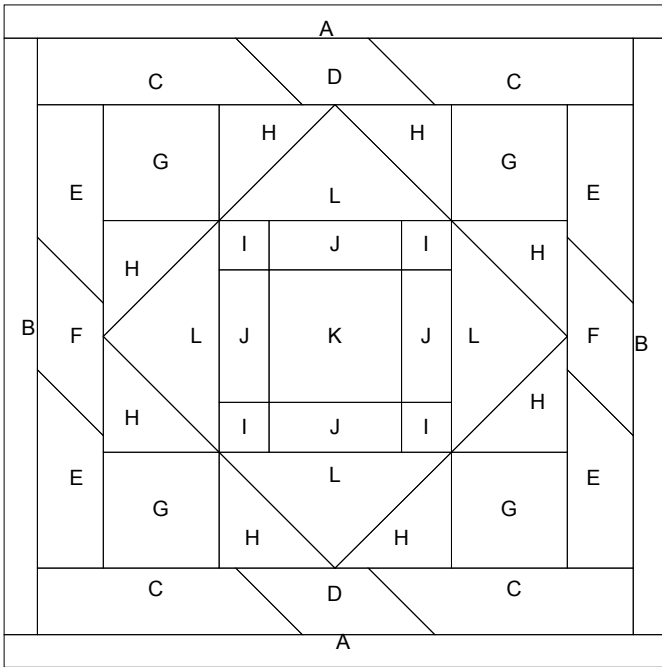

The Jane Stickle Quilt - Block F9

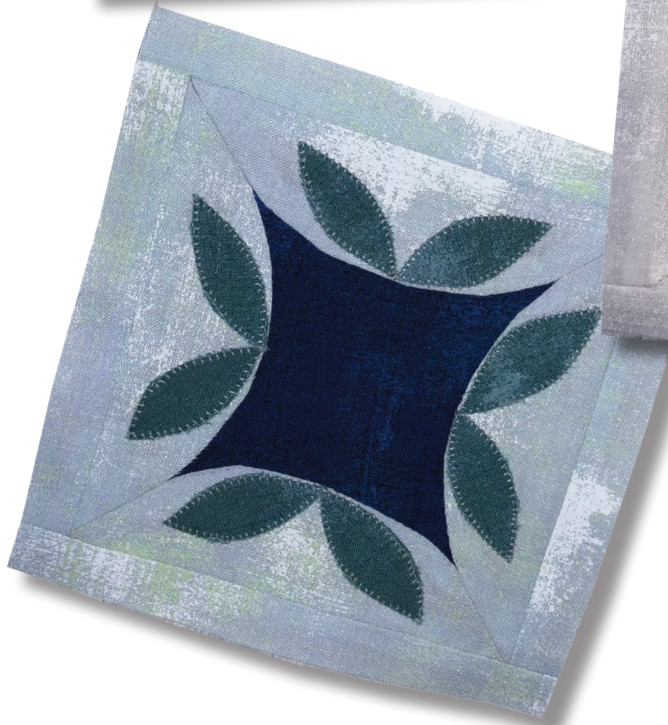

What you need:

Patches	Quantity/size
A*	(2) 1" x 6"
B*	(2) 1" x 5"
C	(4) 2" x 6"
D	(1) 5" x 5"
E	(8) 2" x 2"

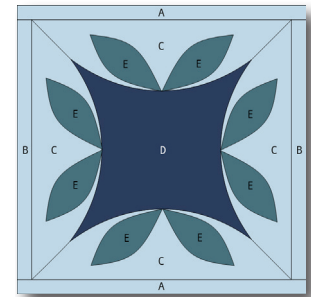

Hobbystash Colorway

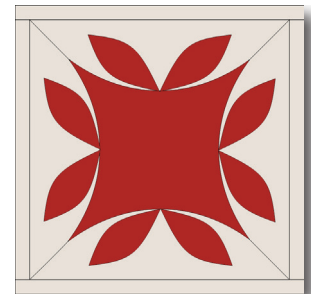

Jane Stickle Colorway

**The actual required width for Unit A and Unit B units is ¾". The increased width specified above allows for squaring the block to exactly 5½".*

Assembly:

1. Using the templates provided on Page F9-2, arrange and sew together four Unit C at the corners.
2. Press under curved inner seam allowance for each Unit C. Appliqué to Unit D.
3. Using the template provided on Page F9-3, appliqué eight melons to the block.
4. Join Unit B to the right side of the block, and then the left.
5. Join Unit A to the top of the block and then the bottom. Square up block to measure 5½" x 5½" square.

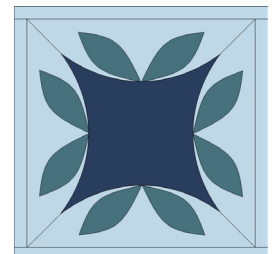
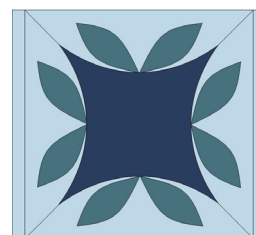
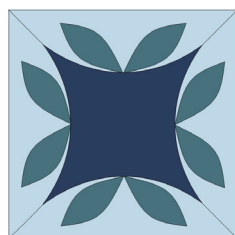
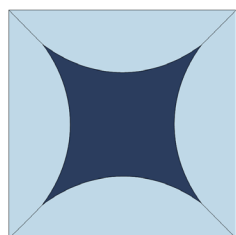
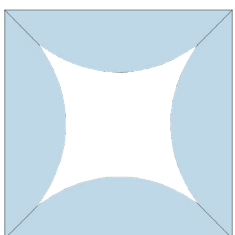

SET PRINTER TO "ACTUAL SIZE" WHEN PRINTING THIS PAGE.

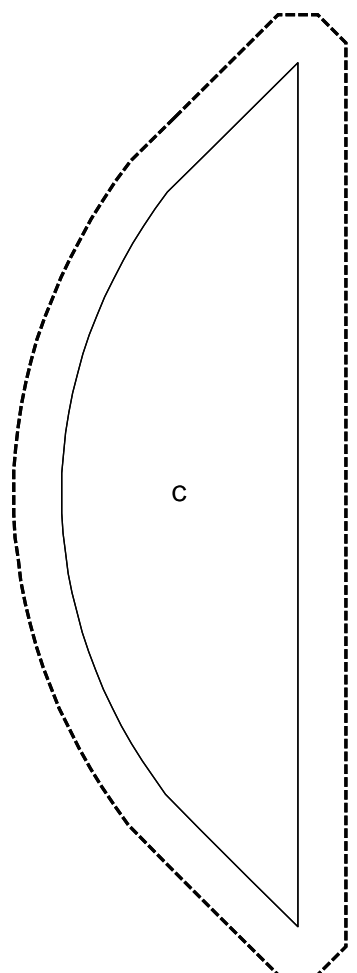
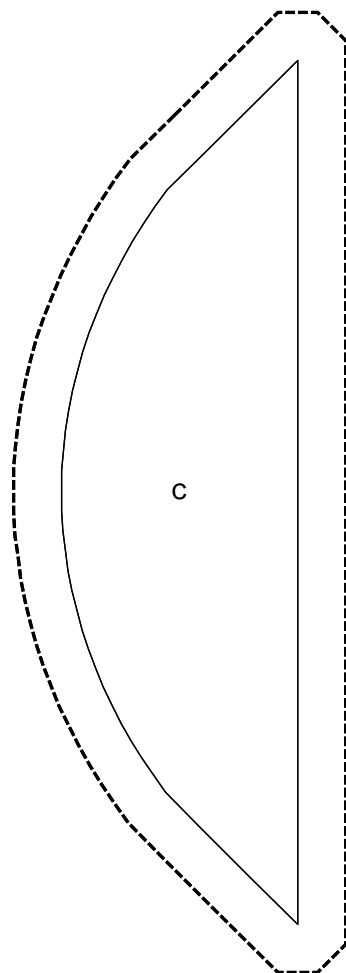
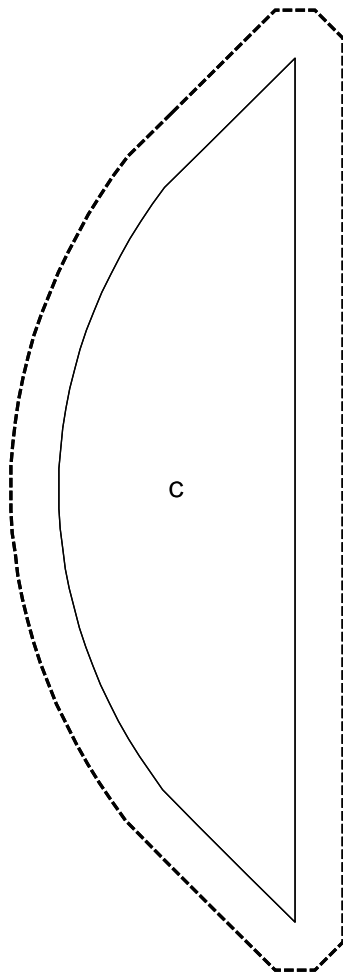
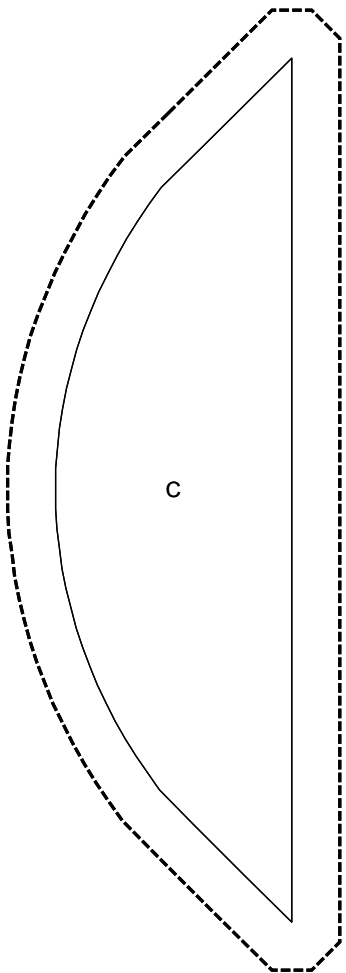
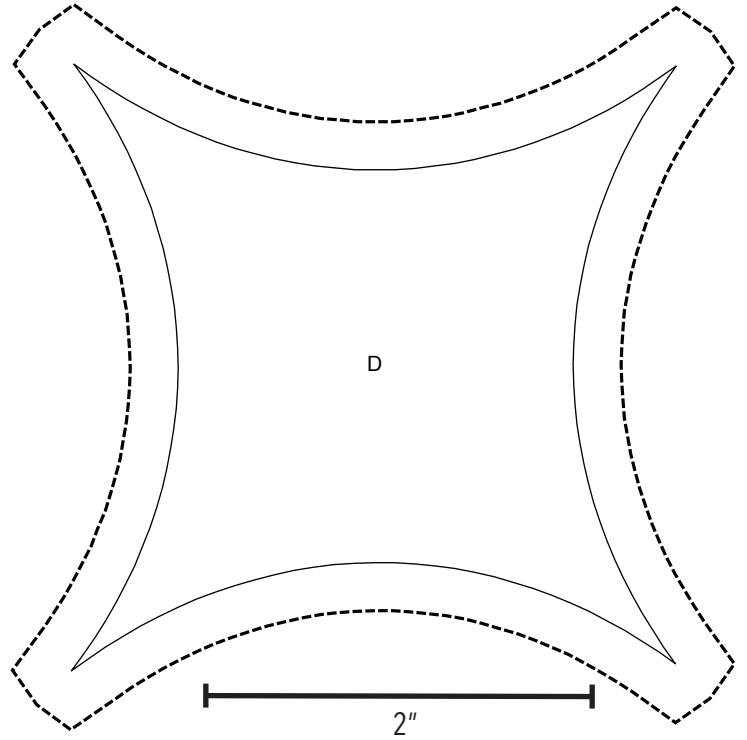
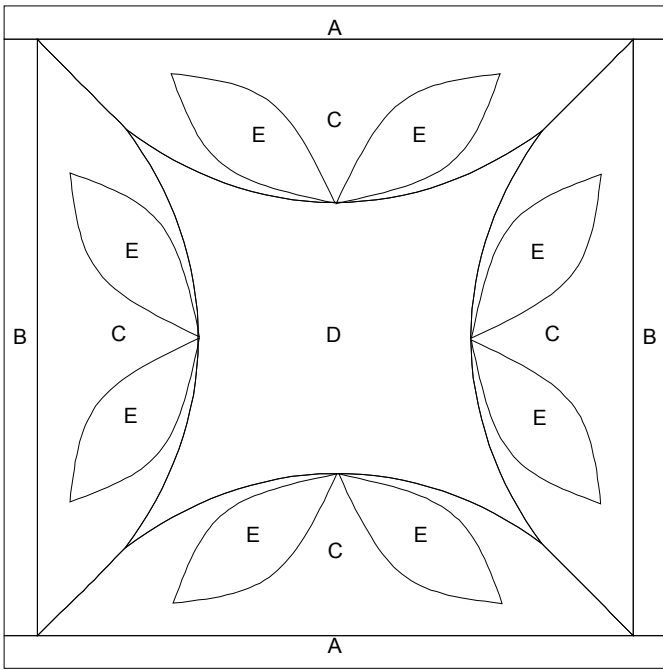

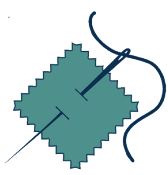

SET PRINTER TO "ACTUAL SIZE" WHEN PRINTING THIS PAGE.

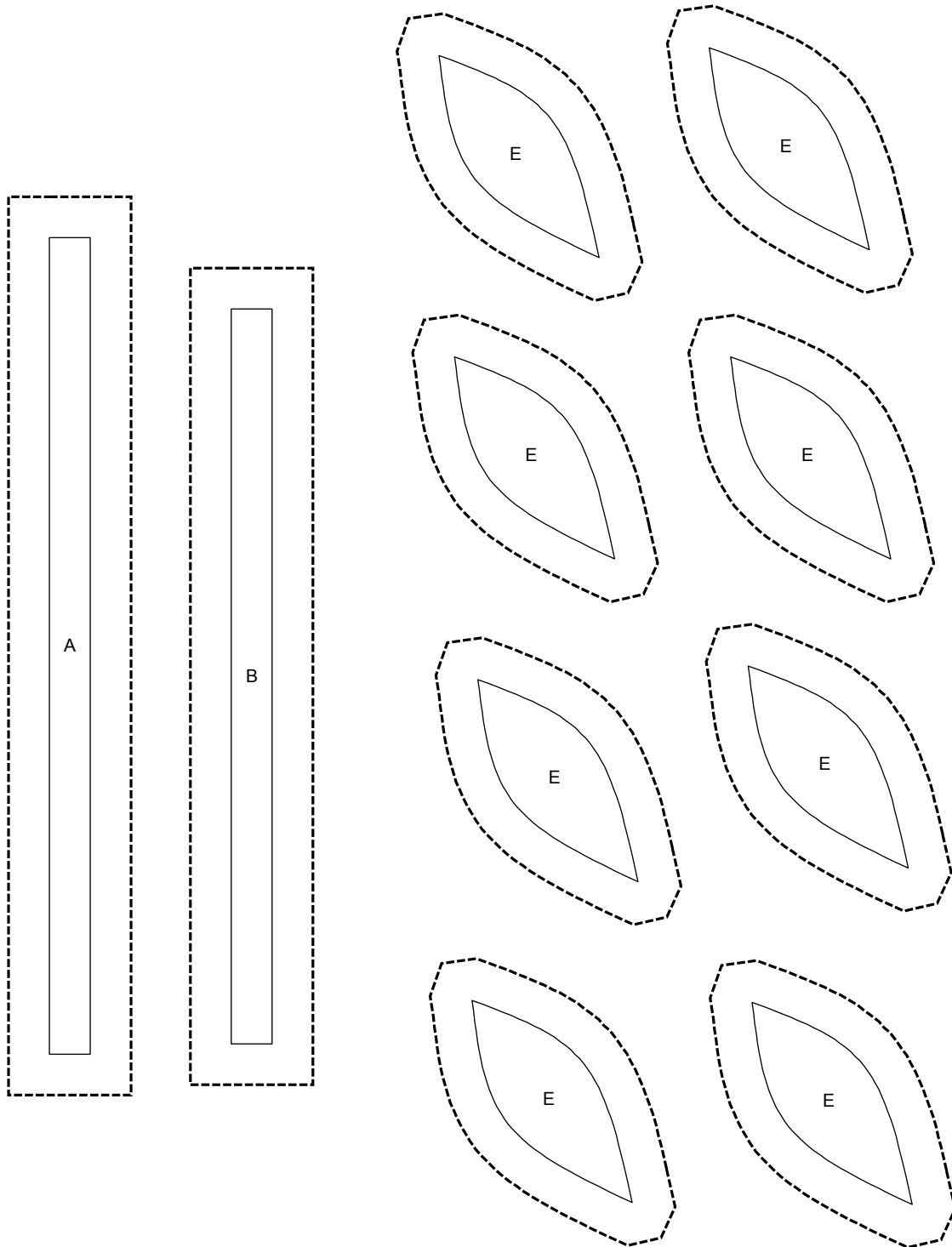

The Jane Stickle Quilt - Block F10



What you need:

Patches	Quantity/size
A*	(2) 1" x 6"
B*	(2) 1" x 5"
C 	(2) 1½" x 3", cut once diagonally
D	(4) 1½" x 4"
E 	(2) 1½" x 3", cut once diagonally
F	(4) 1½" x 4"
G	(1) 3" x 3"
H	(4) 1½" x 2½"

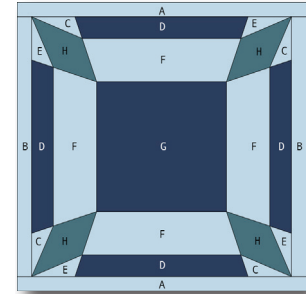

Hobbystash Colorway

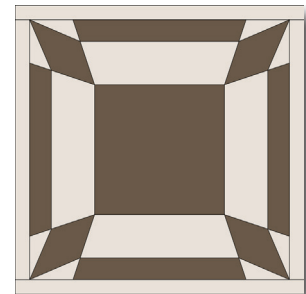

Jane Stickle Colorway

**The actual required width for Unit A and Unit B units is ¾". The increased width specified above allows for squaring the block to exactly 5½".*

Assembly:

- Using the templates provided on Page F10-2, foundation piece the sections of the block.
- Assemble the sections and sew together.
- Join Unit B to the right side of the block, and then the left.
- Join Unit A to the top of the block and then the bottom. Square up block to measure 5½" x 5½" square.

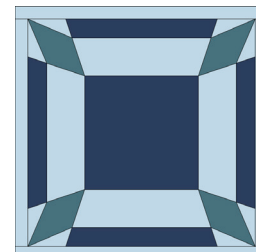
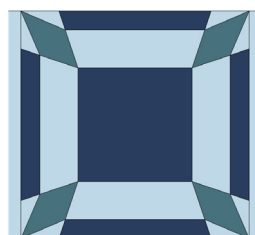
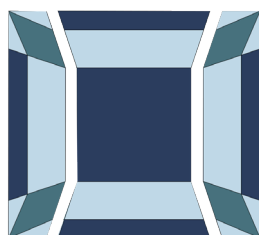

SET PRINTER TO "ACTUAL SIZE" WHEN PRINTING THIS PAGE.

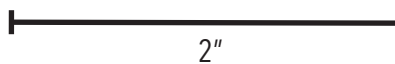
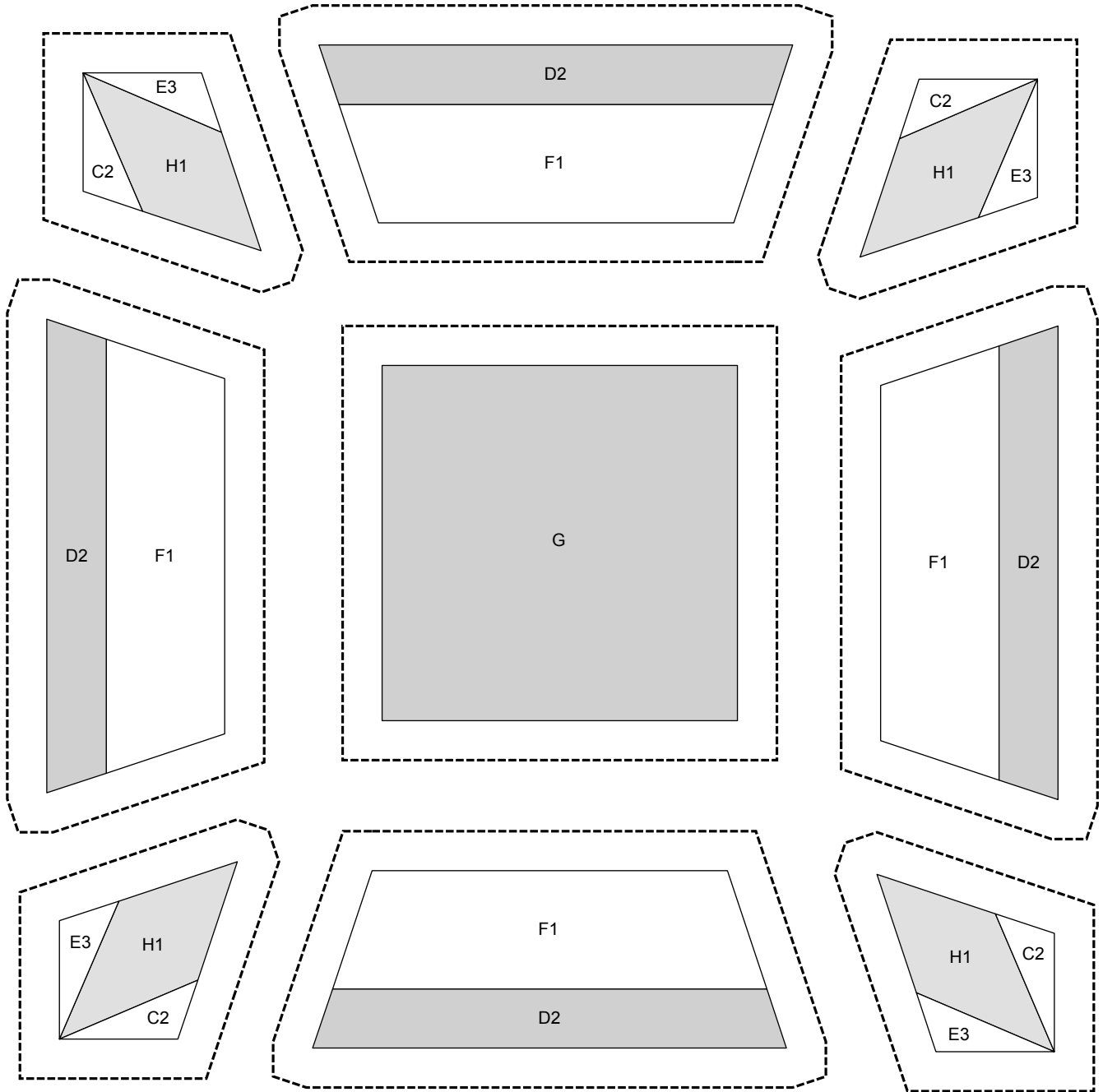

SET PRINTER TO "ACTUAL SIZE" WHEN PRINTING THIS PAGE.

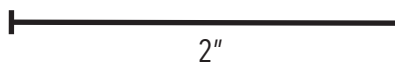
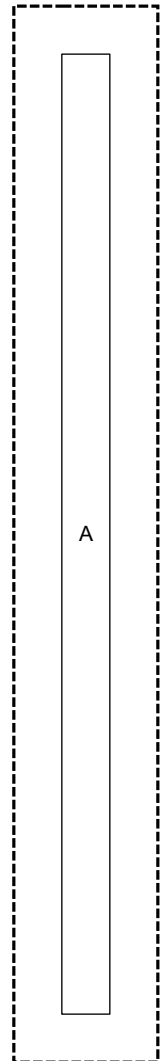
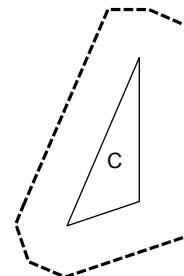
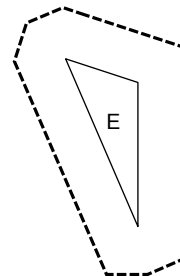
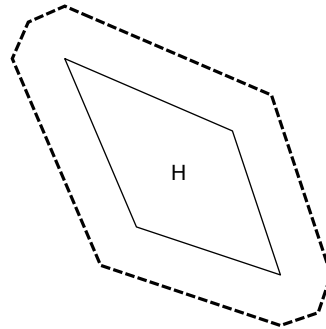
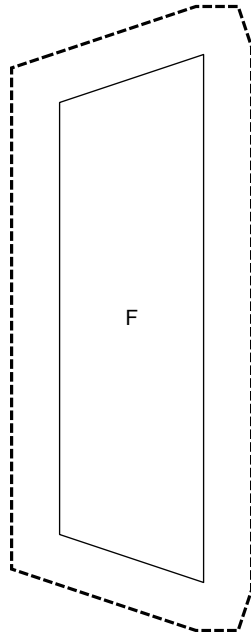
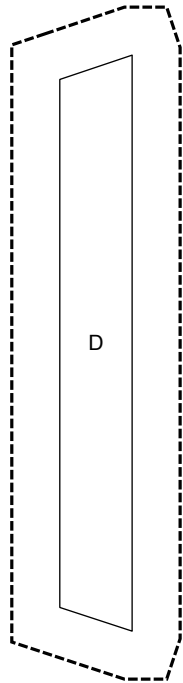
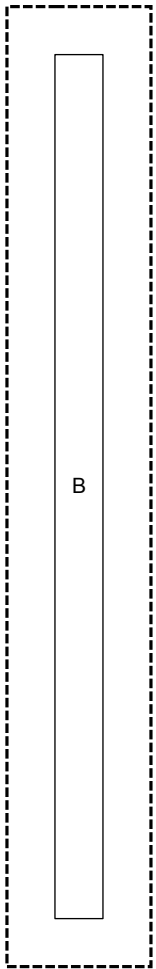
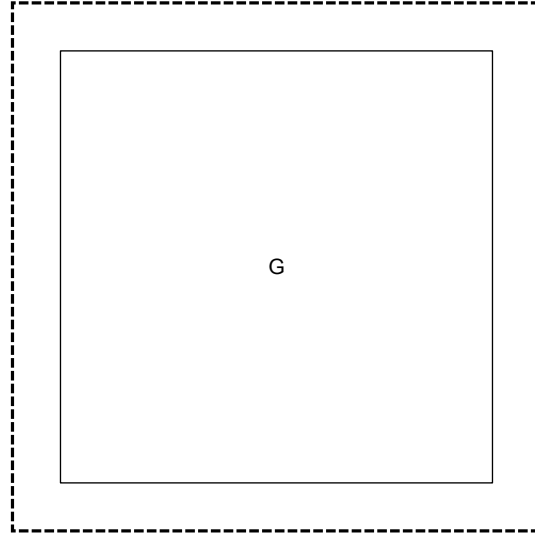
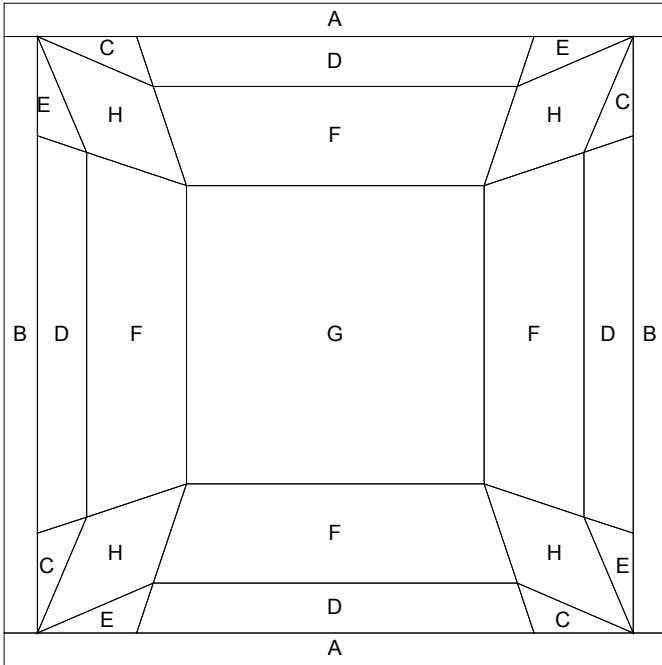

The Jane Stickle Quilt - Block F11



What you need:

Patches	Quantity/size
A*	(2) 1" x 6"
B*	(2) 1" x 5"
C	(4) 1¾" x 1¾"
D	(4) 1¾" x 1¾"
E	(4) 3½" x 3½"
F	(4) 3½" x 3½"
G	(4) 1¾" x 1¾"

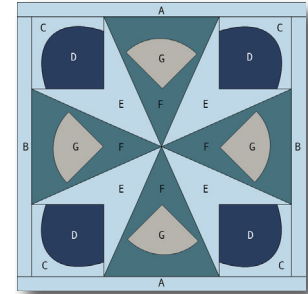

Hobbystash Colorway

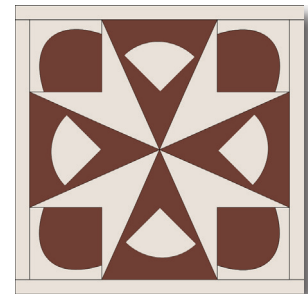

Jane Stickle Colorway

**The actual required width for Unit A and Unit B units is ¾". The increased width specified above allows for squaring the block to exactly 5½".*

Assembly:

- Using the templates provided on Page F11-2, foundation piece the wedge sections.
- Assemble the wedge sections as shown and sew together.
- Using the templates provided on Page F11-2, appliqué or curve piece Unit D to Unit C. Make four. Sew four corners to Step 2 unit. Assemble with Step 2 unit and sew together as shown.
- Appliqué four Unit G quarter circles to the top of the unit from Step 3. Join Unit B to the right side of the block, and then the left.
- Join Unit A to the top of the block and then the bottom. Square up block to measure 5½" x 5½" square.

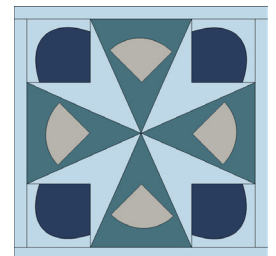
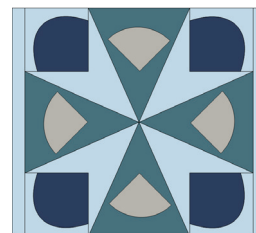
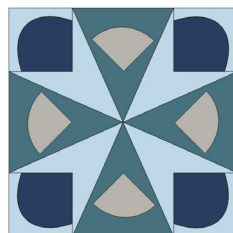
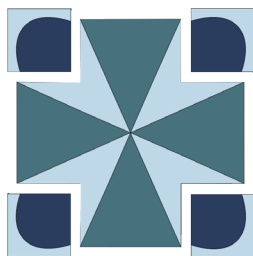
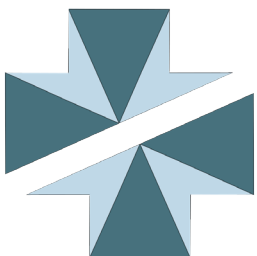

SET PRINTER TO "ACTUAL SIZE" WHEN PRINTING THIS PAGE.

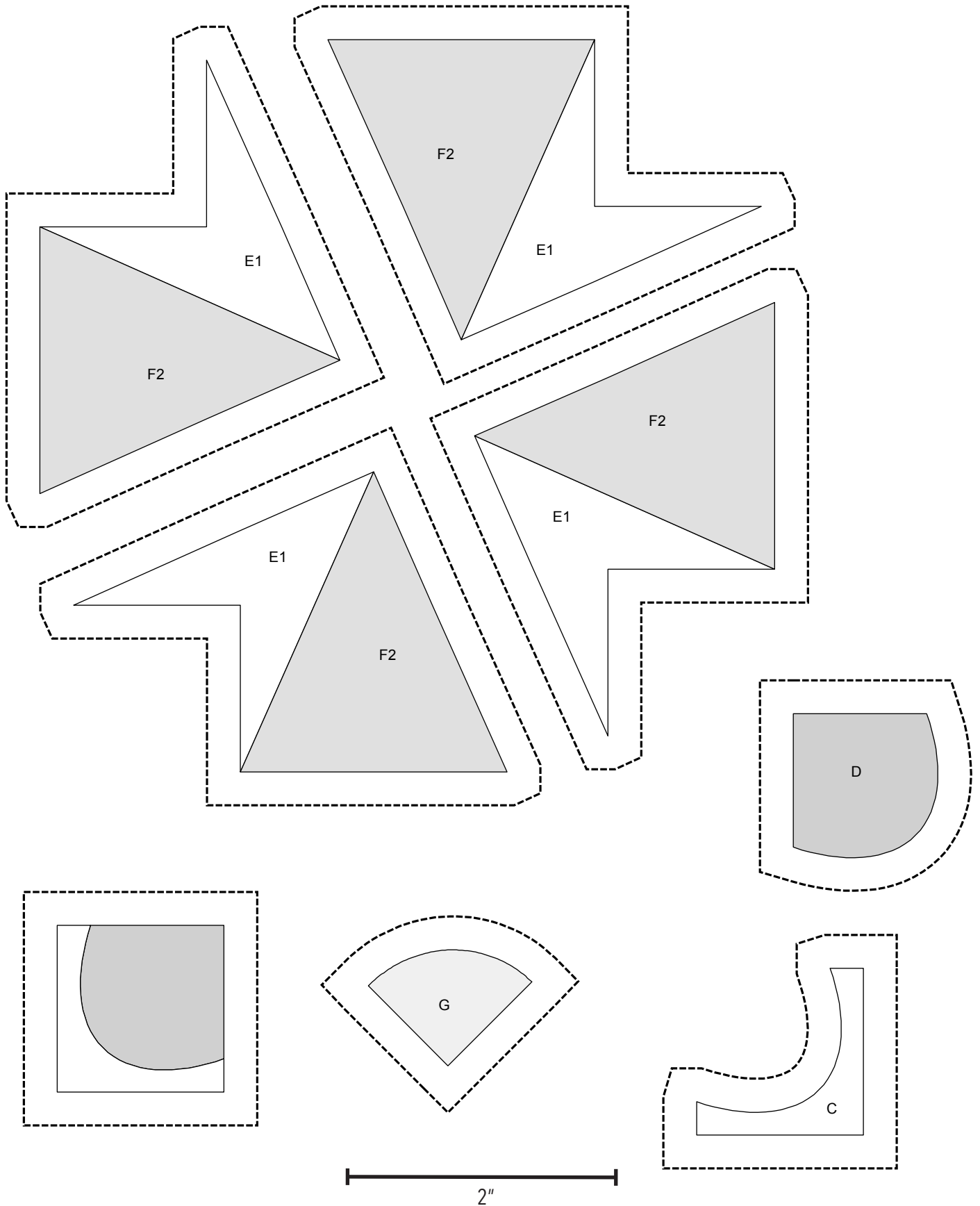

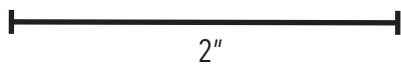
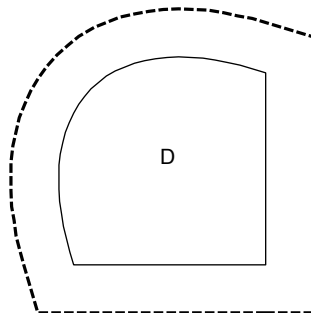
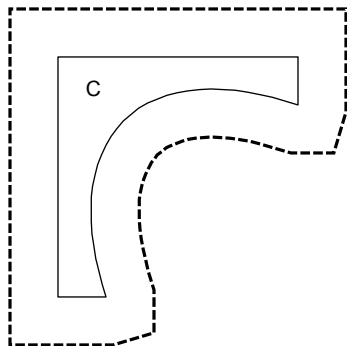
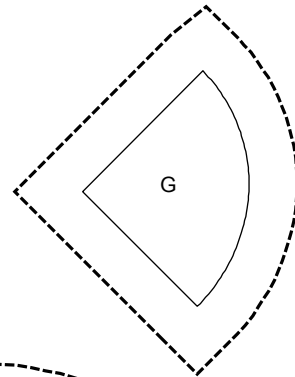
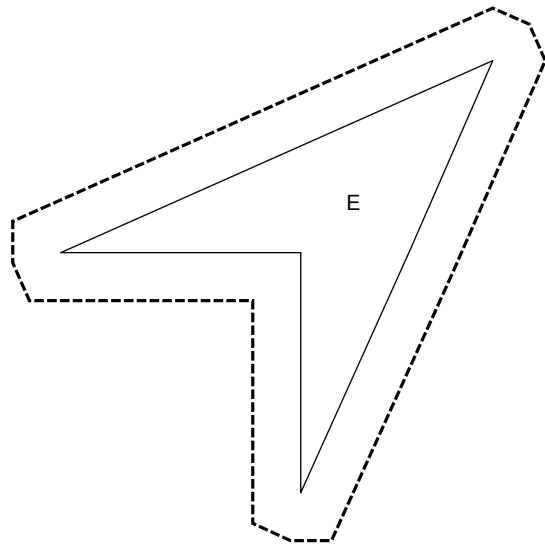
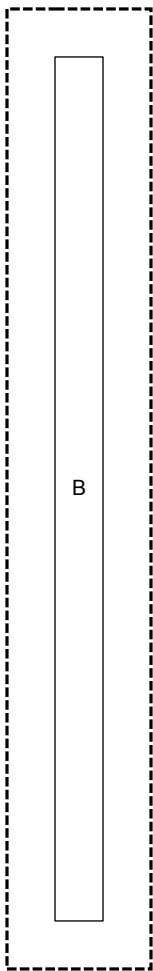
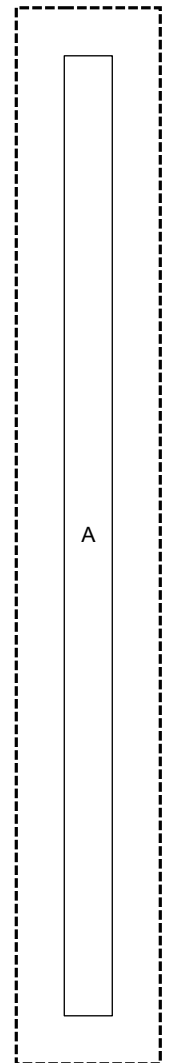
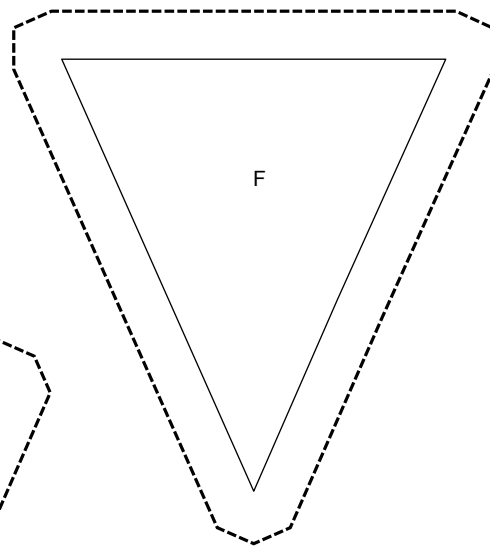
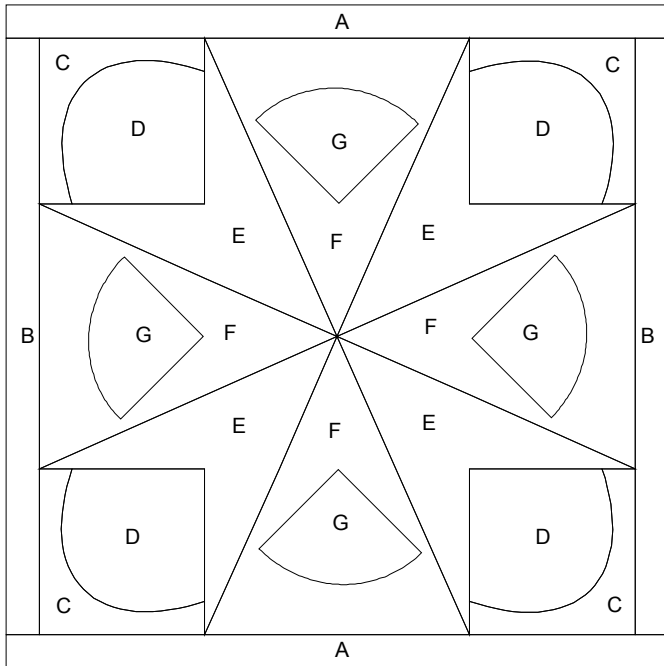

SET PRINTER TO "ACTUAL SIZE" WHEN PRINTING THIS PAGE.

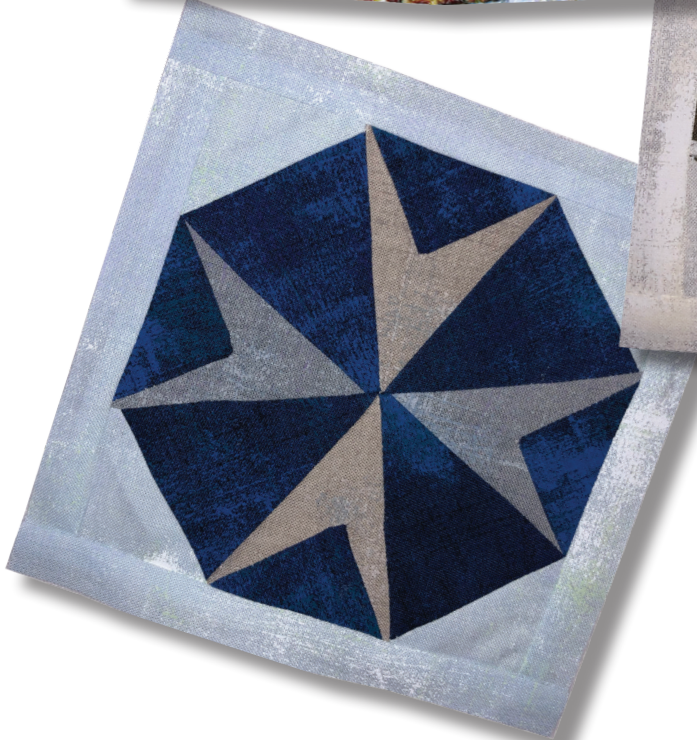

The Jane Stickle Quilt - Block F12



What you need:

Patches	Quantity/size
A*	(2) 1" x 6"
B*	(2) 1" x 5"
C 	(2) 2½" x 2½", cut once diagonally
D 	(1) 3½" x 3½", cut twice diagonally
E	(4) 3½" x 3½"
F	(4) 3½" x 3½"

**The actual required width for Unit A and Unit B units is ¾". The increased width specified above allows for squaring the block to exactly 5½".*

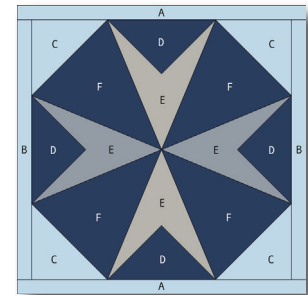

Hobbystash Colorway

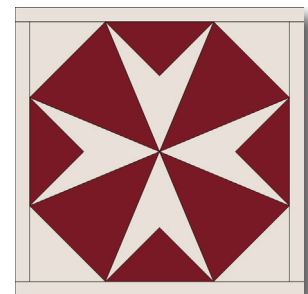

Jane Stickle Colorway

Assembly:

- Using the templates provided on Page F12-2, foundation piece the sections of the block.
- Assemble the sections and sew together.
- Join Unit B to the right side of the block, and then the left.
- Join Unit A to the top of the block and then the bottom. Square up block to measure 5½" x 5½" square.

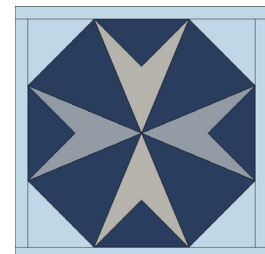
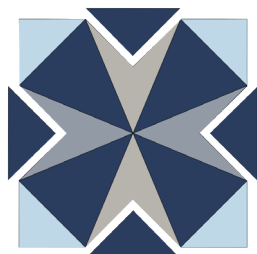

SET PRINTER TO "ACTUAL SIZE" WHEN PRINTING THIS PAGE.

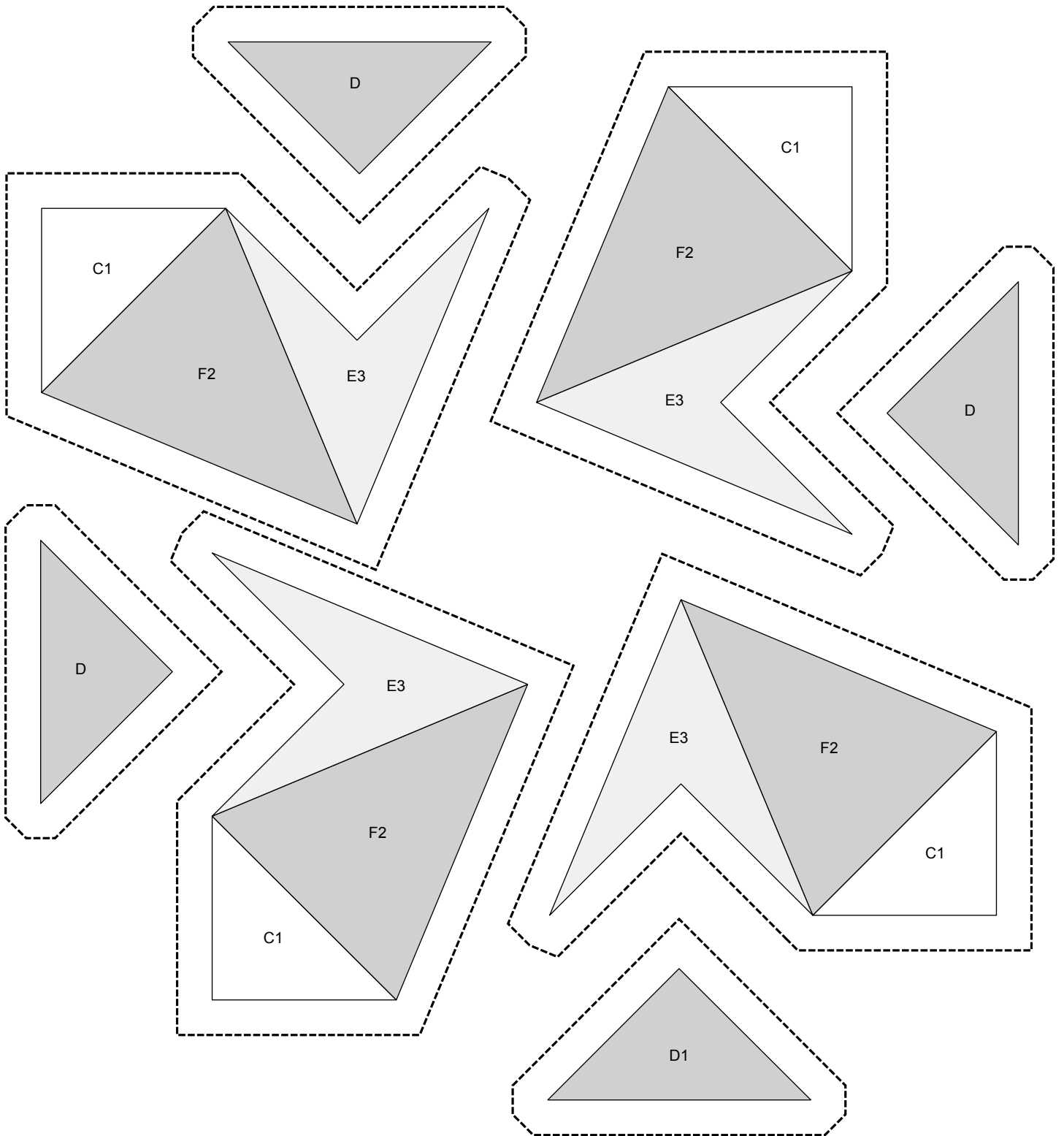

2"

SET PRINTER TO "ACTUAL SIZE" WHEN PRINTING THIS PAGE.

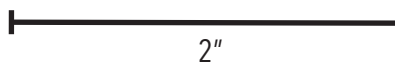
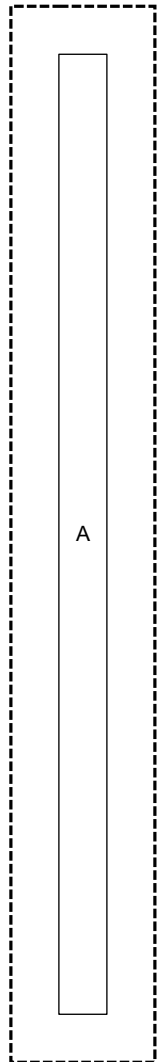
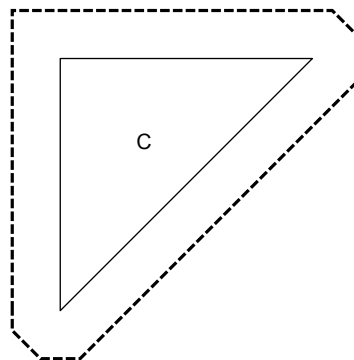
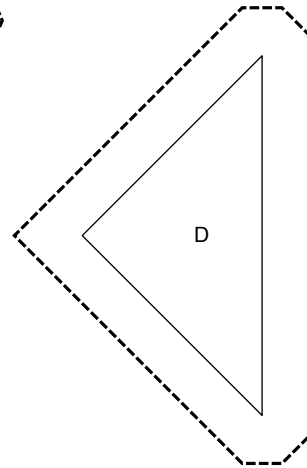
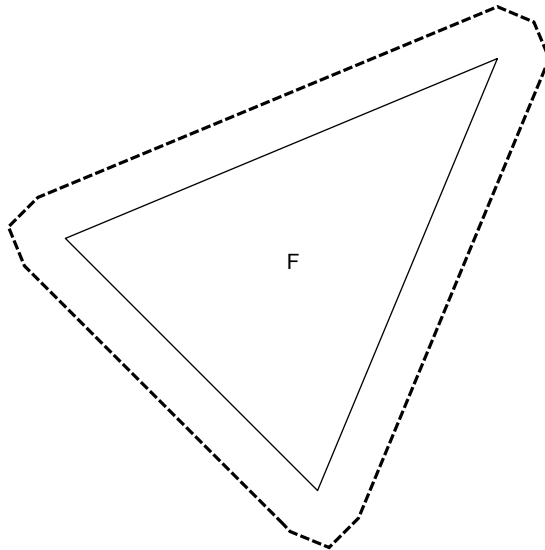
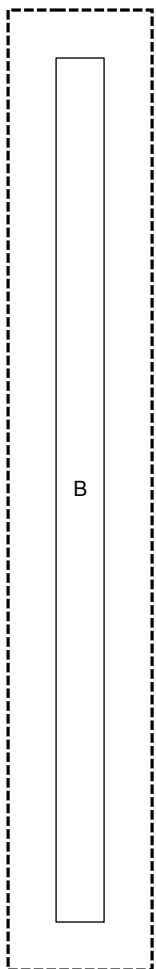
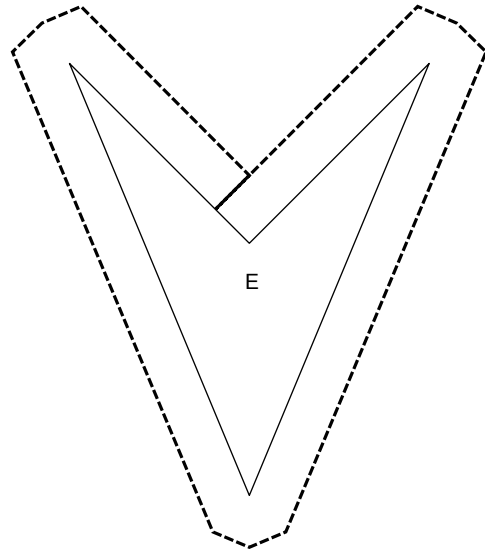
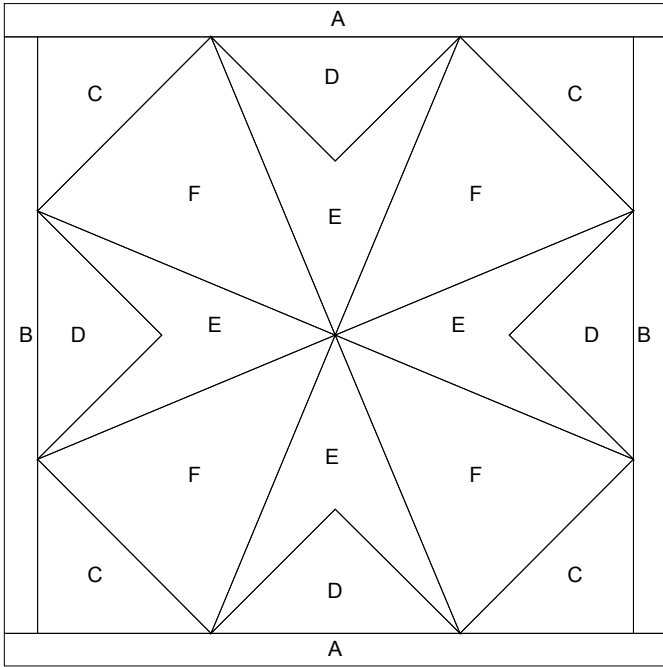

SET PRINTER TO "ACTUAL SIZE" WHEN PRINTING THIS PAGE.

This alternate template eliminates the need for inset seams

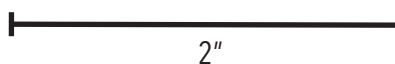
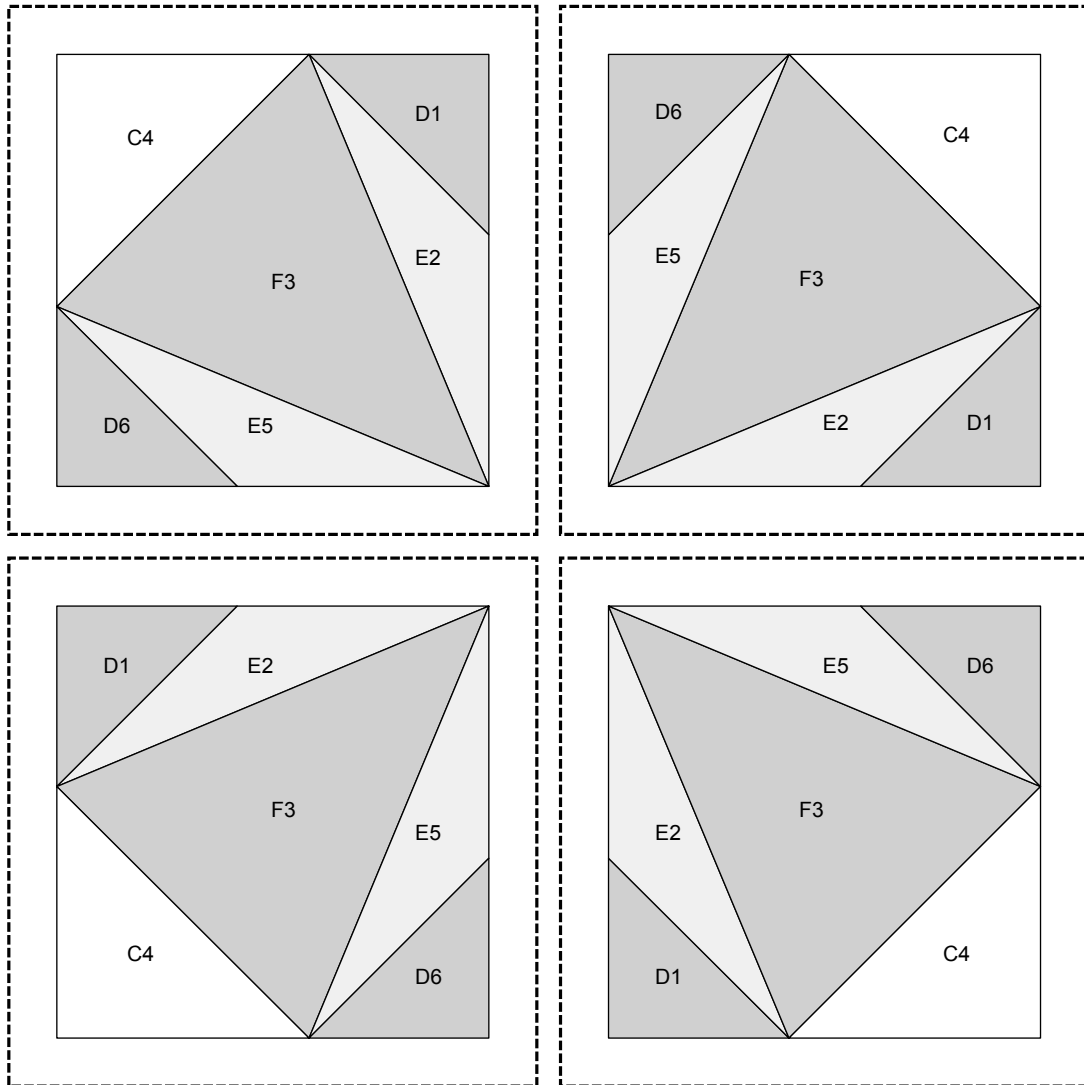

The Jane Stickle Quilt - Block F13



What you need:

Patches	Quantity/size
A*	(2) 1" x 6"
B*	(2) 1" x 5"
C	(1) 6" x 6"
D	(2) 3" x 3"
E	(4) 2" x 3"

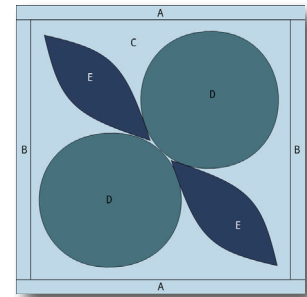

Hobby Stash Colorway

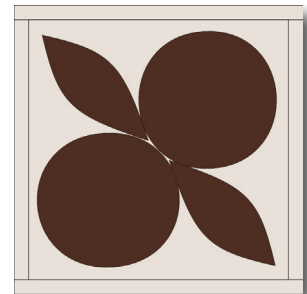

Jane Stickle Colorway

**The actual required width for Unit A and Unit B units is ¾". The increased width specified above allows for squaring the block to exactly 5½".*

Assembly:

1. Using the templates provided on Page F13-2, appliqué the two circles and two melons to Unit C. Square up block to measure 5" x 5" square.
2. Join Unit B to the right side of the block, and then the left.
3. Join Unit A to the top of the block and then the bottom. Square up block to measure 5½" x 5½" square.

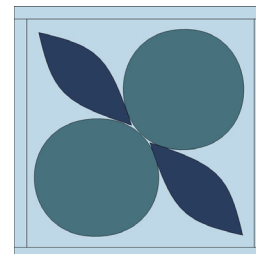
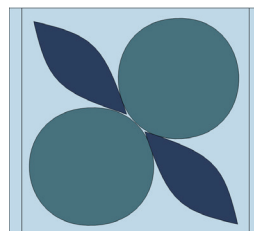
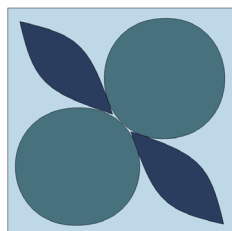

SET PRINTER TO "ACTUAL SIZE" WHEN PRINTING THIS PAGE.

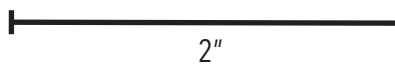
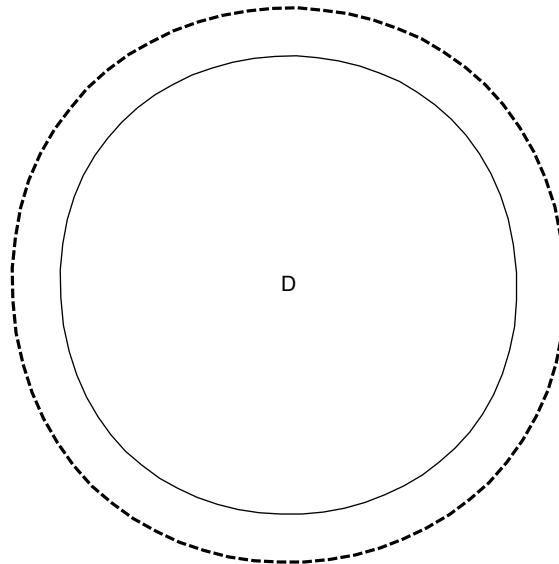
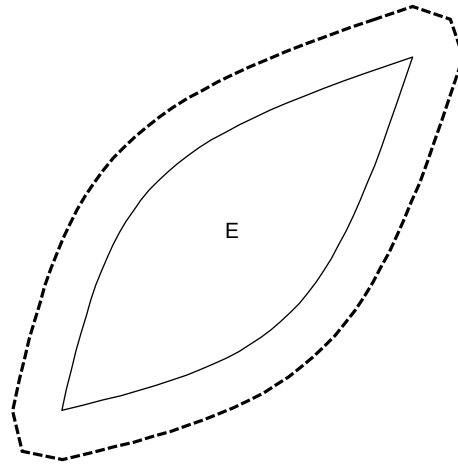

SET PRINTER TO "ACTUAL SIZE" WHEN PRINTING THIS PAGE.

